

74ACTQ821

Quiet Series™ 10-Bit D-Type Flip-Flop with 3-STATE Outputs

General Description

The ACTQ821 is a 10-bit D-type flip-flop with non-inverting 3-STATE outputs arranged in a broadside pinout. The ACTQ821 utilizes Fairchild's Quiet Series™ technology to guarantee quiet output switching and improved dynamic threshold performance. FACT Quiet Series™ features GTO™ output control and undershoot corrector in addition to a split ground bus for superior performance.

Features

- Guaranteed simultaneous switching noise level and dynamic threshold performance
- Guaranteed pin-to-pin skew AC performance
- Non-inverting 3-STATE outputs for bus interfacing
- 4 kV minimum ESD immunity
- Outputs source/sink 24 mA
- Functionally identical to the AM29821

Ordering Code:

Order Number	Package Number	Package Description
74ACTQ821SC	M24B	24-Lead Small Outline Integrated Circuit (SOIC), JEDEC MS-013, 0.300" Wide Body
74ACTQ821SPC	N24C	24-Lead Plastic Dual-In-Line Package (PDIP), JEDEC MS-100, 0.300" Wide

Device also available in Tape and Reel. Specify by appending suffix letter "X" to the ordering code.

Logic Symbols

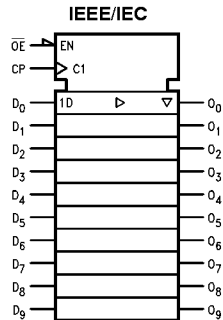
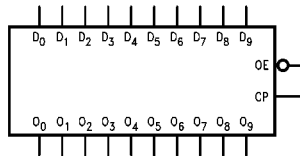

Connection Diagram

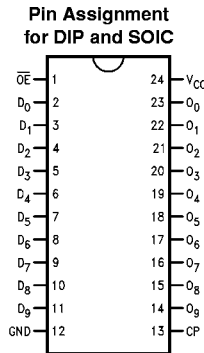

Pin Descriptions

Pin Names	Description
D_0 - D_9	Data Inputs
O_0 - O_9	Data Outputs
\overline{OE}	Output Enable Input
CP	Clock Input

FACT™, Quiet Series™, FACT Quiet Series™, and GTO™ are trademarks of Fairchild Semiconductor Corporation.

Functional Description

The ACTQ821 consists of ten-bit D-type edge-triggered flip-flops. The buffered Clock (CP) and buffered Output Enable (\overline{OE}) are common to all flip-flops. The flip-flops will store the state of their individual D inputs that meet the setup and hold time requirements on the LOW-to-HIGH CP transition. With \overline{OE} LOW the contents of the flip-flops are available at the outputs. When \overline{OE} is HIGH the outputs go to the high impedance state. Operation of the \overline{OE} input does not affect the state of the flip-flops.

The ACTQ821 is functionally and pin compatible with the AM29821.

Function Table

Inputs			Internal	Outputs	Function
\overline{OE}	CP	D	Q	O	
H	↗	L	L	Z	High Z
H	↗	H	H	Z	High Z
L	↗	L	L	L	Load
L	↗	H	H	H	Load

H = HIGH Voltage Level
 L = LOW Voltage Level
 Z = HIGH Impedance
 ↗ = LOW-to-HIGH Clock Transition

Logic Diagram

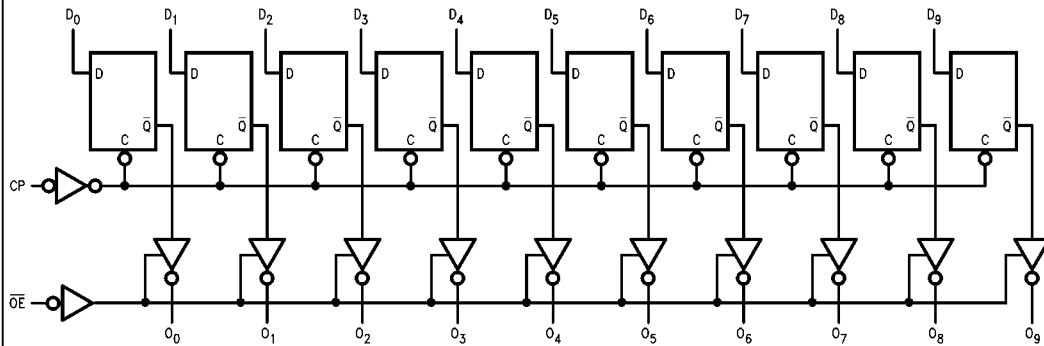

Please note that this diagram is provided only for the understanding of logic operations and should not be used to estimate propagation delays.

Absolute Maximum Ratings (Note 1)		Junction Temperature (T_J)
Supply Voltage (V_{CC})	-0.5V to +7.0V	PDIP 140°C
DC Input Diode Current (I_{IK})		
$V_I = -0.5V$	-20 mA	
$V_I = V_{CC} + 0.5V$	+20 mA	
DC Input Voltage (V_I)	-0.5V to $V_{CC} + 0.5V$	
DC Output Diode Current (I_{OK})		
$V_O = -0.5V$	-20 mA	
$V_O = V_{CC} + 0.5V$	+20 mA	
DC Output Voltage (V_O)	-0.5V to $V_{CC} + 0.5V$	
DC Output Source		
or Sink Current (I_O)	± 50 mA	
DC V_{CC} or Ground Current		
per Output Pin (I_{CC} or I_{GND})	± 50 mA	
Storage Temperature (T_{STG})	-65°C to +150°C	
DC Latch-Up Source		
or Sink Current	± 300 mA	

Recommended Operating Conditions	
Supply Voltage (V_{CC})	4.5V to 5.5V
Input Voltage (V_I)	0V to V_{CC}
Output Voltage (V_O)	0V to V_{CC}
Operating Temperature (T_A)	-40°C to +85°C
Minimum Input Edge Rate $\Delta V/\Delta t$	
Minimum Input Edge Rate $\Delta V/\Delta t$	125 mV/ns
V_{IN} from 0.8V to 2.0V	
V_{CC} @ 4.5V, 5.5V	

Note 1: Absolute maximum ratings are those values beyond which damage to the device may occur. The databook specifications should be met, without exception, to ensure that the system design is reliable over its power supply, temperature, and output/input loading variables. Fairchild does not recommend operation of FACT™ circuits outside databook specifications.

DC Electrical Characteristics

Symbol	Parameter	V_{CC} (V)	$T_A = +25^\circ\text{C}$		$T_A = -40^\circ\text{C to } +85^\circ\text{C}$		Units	Conditions
			Typ	Guaranteed Limits				
V_{IH}	Minimum High Level Input Voltage	4.5	1.5	2.0	2.0		V	$V_{OUT} = 0.1V$ or $V_{CC} - 0.1V$
		5.5	1.5	2.0	2.0			
V_{IL}	Maximum Low Level Input Voltage	4.5	1.5	0.8	0.8		V	$V_{OUT} = 0.1V$ or $V_{CC} - 0.1V$
		5.5	1.5	0.8	0.8			
V_{OH}	Minimum High Level Output Voltage	4.5	4.49	4.4	4.4		V	$I_{OUT} = -50 \mu A$
		5.5	5.49	5.4	5.4			
		4.5		3.86	3.76			
5.5		4.86	4.76					
V_{OL}	Maximum Low Level Output Voltage	4.5	0.001	0.1	0.1		V	$I_{OUT} = 50 \mu A$
		5.5	0.001	0.1	0.1			
		4.5		0.36	0.44			
5.5		0.36	0.44					
I_{IN}	Maximum Input Leakage Current	5.5		± 0.1	± 1.0		μA	$V_I = V_{CC}, GND$
I_{OZ}	Maximum 3-STATE Leakage Current	5.5		± 0.5	± 5.0		μA	$V_I = V_{IL}, V_{IH}$ $V_O = V_{CC}, GND$
I_{CCT}	Maximum I_{CC} /Input	5.5	0.6		1.5		mA	$V_I = V_{CC} - 2.1V$
I_{OLD}	Minimum Dynamic	5.5			75		mA	$V_{OLD} = 1.65V$ Max
I_{OHD}	Output Current (Note 3)	5.5			-75		mA	$V_{OHD} = 3.85V$ Min
I_{CC}	Maximum Quiescent Supply Current	5.5		8.0	80.0		μA	$V_{IN} = V_{CC}$ or GND
V_{OLP}	Quiet Output Maximum Dynamic V_{OL}	5.0	1.1	1.5			V	Figure 1, Figure 2 (Note 4)(Note 5)
V_{OLV}	Quiet Output Minimum Dynamic V_{OL}	5.0	-0.6	-1.2			V	Figure 1, Figure 2 (Note 4)(Note 5)
V_{IHD}	Minimum High Level Dynamic Input Voltage	5.0	1.9	2.2			V	(Note 4)(Note 6)
V_{ILD}	Maximum Low Level Dynamic Input Voltage	5.0	1.2	0.8			V	(Note 4)(Note 6)

Note 2: All outputs loaded; thresholds on input associated with output under test.

Note 3: Maximum test duration 2.0 ms, one output loaded at a time.

Note 4: DIP package.

Note 5: Max number of outputs defined as (n). Data inputs are driven 0V to 3V. One output @ GND.

DC Electrical Characteristics (Continued)

Note 6: Maximum number of data inputs (n) switching. (n-1) inputs switching 0V to 3V. Input-under-test switching: 3V to threshold (V_{ILD}), 0V to threshold (V_{IHD}), $f = 1$ MHz.

AC Electrical Characteristics

Symbol	Parameter	V_{CC} (V) (Note 7)	$T_A = +25^\circ\text{C}$ $C_L = 50$ pF			$T_A = -40^\circ\text{C to } +85^\circ\text{C}$ $C_L = 50$ pF		Units
			Min	Typ	Max	Min	Max	
f_{max}	Maximum Clock Frequency	5.0	120			110		MHz
t_{PLH} t_{PHL}	Propagation Delay CP to O_n	5.0	3.0	6.5	9.5	2.5	10.5	ns
t_{PZH} t_{PZL}	Output Enable Time \overline{OE} to O_n	5.0	3.0	7.5	10.5	2.5	11.5	ns
t_{PHZ} t_{PLZ}	Output Disable Time \overline{OE} to O_n	5.0	1.0	6.5	8.5	1.0	9.0	ns
t_{OSLH} t_{OSHL}	Output to Output Skew CP to O_n (Note 8)	5.0	0.5		1.0	1.0		ns

Note 7: Voltage Range 5.0 is $5.0V \pm 0.5V$

Note 8: Skew is defined as the absolute value of the difference between the actual propagation delay for any two outputs within the same packaged device. The specification applies to any outputs switching in the same direction, either HIGH to LOW (t_{OSHL}) or LOW to HIGH (t_{OSLH}). Parameter guaranteed by design. Not tested.

AC Operating Requirements

Symbol	Parameter	V_{CC} (V) (Note 9)	$T_A = +25^\circ\text{C}$ $C_L = 50$ pF		$T_A = -40^\circ\text{C to } +85^\circ\text{C}$ $C_L = 50$ pF		Units
			Typ	Guaranteed Minimum			
t_S	Setup Time, HIGH or LOW D_n to CP	5.0		3.0	3.0		ns
t_H	Hold Time, HIGH or LOW D_n to CP	5.0		1.5	1.5		ns
t_H	CP Pulse Width HIGH or LOW	5.0		4.5	5.5		ns

Note 9: Voltage Range 5.0 is $5.0V \pm 0.5V$

Capacitance

Symbol	Parameter	Typ	Units	Conditions
C_{IN}	Input Capacitance	4.5	pF	$V_{CC} = \text{OPEN}$
C_{PD}	Power Dissipation Capacitance	55.0	pF	$V_{CC} = 5.0V$

FACT Noise Characteristics

The setup of a noise characteristics measurement is critical to the accuracy and repeatability of the tests. The following is a brief description of the setup used to measure the noise characteristics of FACT.

Equipment:

Hewlett Packard Model 8180A Word Generator
PC-163A Test Fixture
Tektronics Model 7854 Oscilloscope

Procedure:

1. Verify Test Fixture Loading: Standard Load 50 pF, 500Ω.
2. Deskew the HFS generator so that no two channels have greater than 150 ps skew between them. This requires that the oscilloscope be deskewed first. It is important to deskew the HFS generator channels before testing. This will ensure that the outputs switch simultaneously.
3. Terminate all inputs and outputs to ensure proper loading of the outputs and that the input levels are at the correct voltage.
4. Set the HFS generator to toggle all but one output at a frequency of 1 MHz. Greater frequencies will increase DUT heating and effect the results of the measurement.
5. Set the HFS generator input levels at 0V LOW and 3V HIGH for ACT devices and 0V LOW and 5V HIGH for AC devices. Verify levels with an oscilloscope.

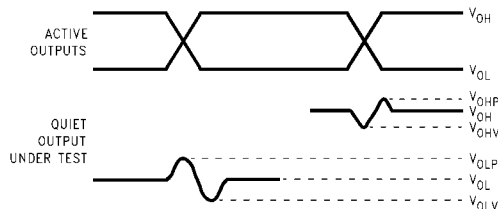

Note 10: V_{OHV} and V_{OLP} are measured with respect to ground reference.

Note 11: Input pulses have the following characteristics: $f = 1$ MHz, $t_r = 3$ ns, $t_f = 3$ ns, skew < 150 ps.

FIGURE 1. Quiet Output Noise Voltage Waveforms

V_{OLP}/V_{OLV} and V_{OHP}/V_{OHV} :

- Determine the quiet output pin that demonstrates the greatest noise levels. The worst case pin will usually be the furthest from the ground pin. Monitor the output voltages using a 50Ω coaxial cable plugged into a standard SMB type connector on the test fixture. Do not use an active FET probe.
- Measure V_{OLP} and V_{OLV} on the quiet output during the worst case transition for active and enable. Measure V_{OHP} and V_{OHV} on the quiet output during the worst case active and enable transition.
- Verify that the GND reference recorded on the oscilloscope has not drifted to ensure the accuracy and repeatability of the measurements.

V_{ILD} and V_{IHD} :

- Monitor one of the switching outputs using a 50Ω coaxial cable plugged into a standard SMB type connector on the test fixture. Do not use an active FET probe.
- First increase the input LOW voltage level, V_{IL} , until the output begins to oscillate or steps out a min of 2 ns. Oscillation is defined as noise on the output LOW level that exceeds V_{IL} limits, or on output HIGH levels that exceed V_{IH} limits. The input LOW voltage level at which oscillation occurs is defined as V_{ILD} .
- Next decrease the input HIGH voltage level V_{IH} until the output begins to oscillate or steps out a min of 2ns. Oscillation is defined as noise on the output LOW level that exceeds V_{IL} limits, or on output HIGH levels that exceed V_{IH} limits. The input HIGH voltage level at which oscillation occurs is defined as V_{IHD} .
- Verify that the GND reference recorded on the oscilloscope has not drifted to ensure the accuracy and repeatability of the measurements.

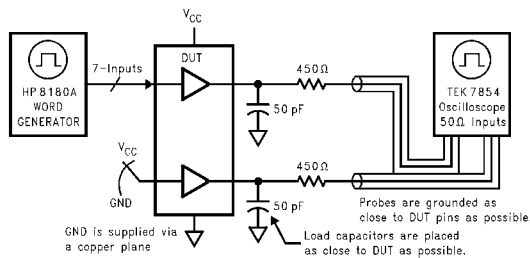
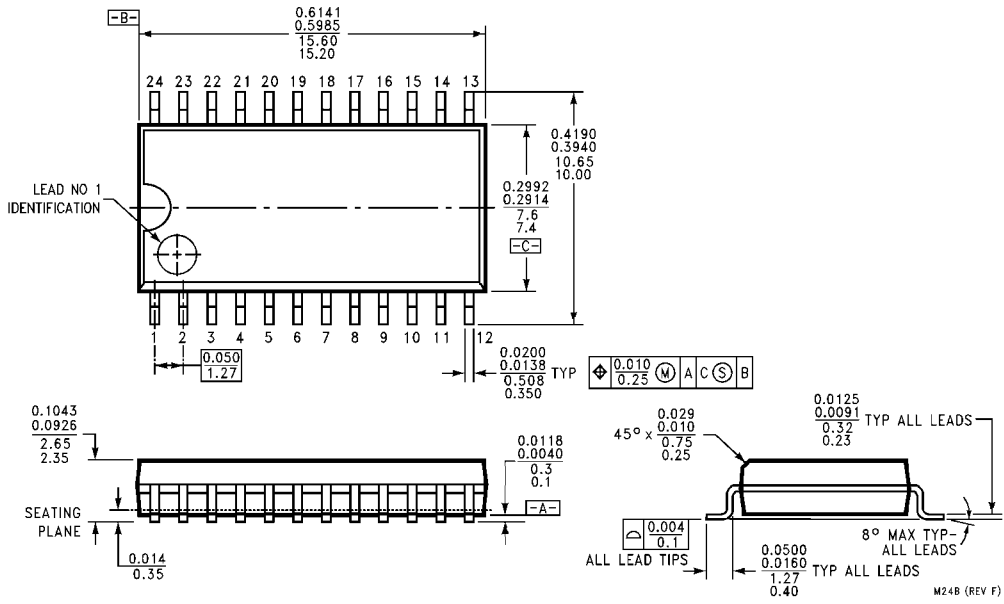

FIGURE 2. Simultaneous Switching Test Circuit

Physical Dimensions inches (millimeters) unless otherwise noted



**24-Lead Small Outline Integrated Circuit (SOIC), JEDEC MS-013, 0.300" Wide Body
 Package Number M24B**

Physical Dimensions inches (millimeters) unless otherwise noted (Continued)

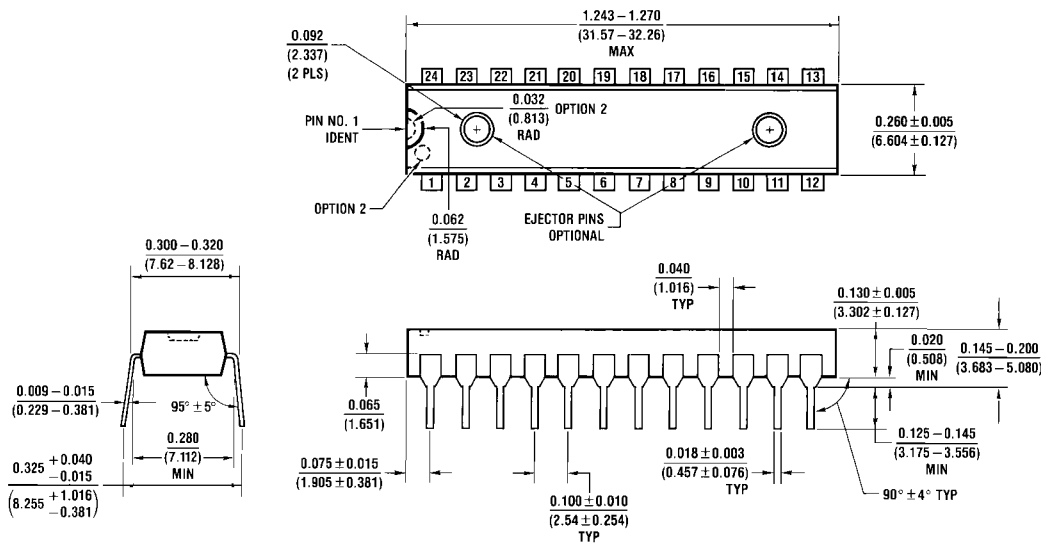

N24C (REV F)

**24-Lead Plastic Dual-In-Line Package (PDIP), JEDEC MS-100, 0.300" Wide
Package Number N24C**

LIFE SUPPORT POLICY

FAIRCHILD'S PRODUCTS ARE NOT AUTHORIZED FOR USE AS CRITICAL COMPONENTS IN LIFE SUPPORT DEVICES OR SYSTEMS WITHOUT THE EXPRESS WRITTEN APPROVAL OF THE PRESIDENT OF FAIRCHILD SEMICONDUCTOR CORPORATION. As used herein:

1. Life support devices or systems are devices or systems which, (a) are intended for surgical implant into the body, or (b) support or sustain life, and (c) whose failure to perform when properly used in accordance with instructions for use provided in the labeling, can be reasonably expected to result in a significant injury to the user.
2. A critical component in any component of a life support device or system whose failure to perform can be reasonably expected to cause the failure of the life support device or system, or to affect its safety or effectiveness.

www.fairchildsemi.com

Fairchild does not assume any responsibility for use of any circuitry described, no circuit patent licenses are implied and Fairchild reserves the right at any time without notice to change said circuitry and specifications.