

# 2SA1494

Silicon PNP Epitaxial Planar Transistor (Complement to type 2SC3858)

Application : Audio and General Purpose

■ Absolute maximum ratings (Ta=25°C)

Symbol	Ratings	Unit
V <sub>CB0</sub>	-200	V
V <sub>CEO</sub>	-200	V
V <sub>EB0</sub>	-6	V
I <sub>C</sub>	-17	A
I <sub>B</sub>	-5	A
P <sub>C</sub>	200(T <sub>C</sub> =25°C)	W
T <sub>J</sub>	150	°C
T <sub>stg</sub>	-55 to +150	°C

■ Electrical Characteristics (Ta=25°C)

Symbol	Conditions	Ratings	Unit
I <sub>CB0</sub>	V <sub>CB</sub> =-200V	-100max	μA
I <sub>EB0</sub>	V <sub>EB</sub> =-6V	-100max	μA
V <sub>(BR)CEO</sub>	I <sub>C</sub> =-50mA	-200min	V
h <sub>FE</sub>	V <sub>CE</sub> =-4V, I <sub>C</sub> =-8A	50min*	
V <sub>CE(sat)</sub>	I <sub>C</sub> =-10A, I <sub>B</sub> =-1A	-2.5max	V
f <sub>r</sub>	V <sub>CE</sub> =-12V, I <sub>E</sub> =1A	20typ	MHz
COB	V <sub>CB</sub> =-10V, f=1MHz	500typ	pF

\*h<sub>FE</sub> Rank Y(50 to 100), P(70 to 140), G(90 to 180)

■ Typical Switching Characteristics (Common Emitter)

V <sub>CC</sub> (V)	R <sub>L</sub> (Ω)	I <sub>C</sub> (A)	V <sub>BB1</sub> (V)	V <sub>BB2</sub> (V)	I <sub>B1</sub> (A)	I <sub>B2</sub> (A)	t <sub>on</sub> (μs)	t <sub>stg</sub> (μs)	t <sub>f</sub> (μs)
-40	4	-10	-10	5	-1	1	0.6typ	0.9typ	0.2typ

External Dimensions MT-200

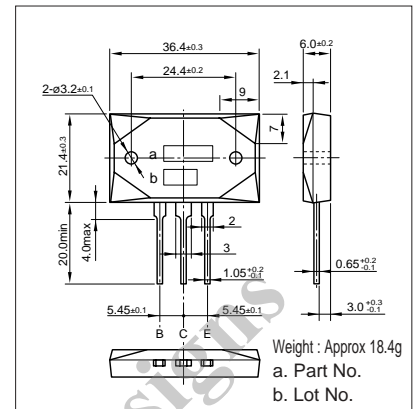

I<sub>C</sub>-V<sub>CE</sub> Characteristics (Typical)

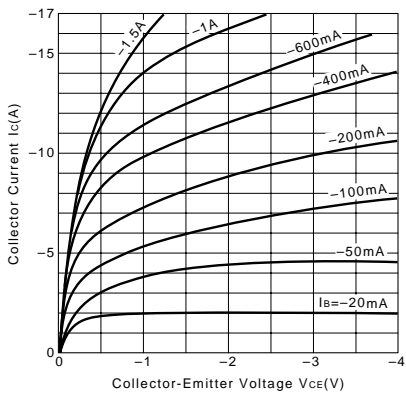

V<sub>CE(sat)</sub>-I<sub>B</sub> Characteristics (Typical)

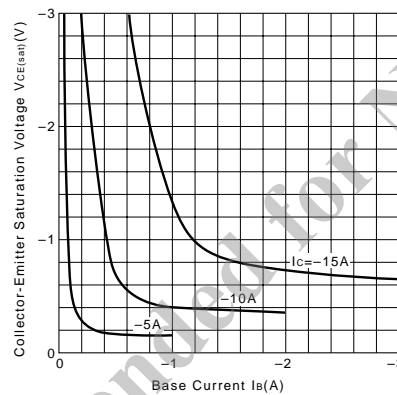

I<sub>C</sub>-V<sub>BE</sub> Temperature Characteristics (Typical)

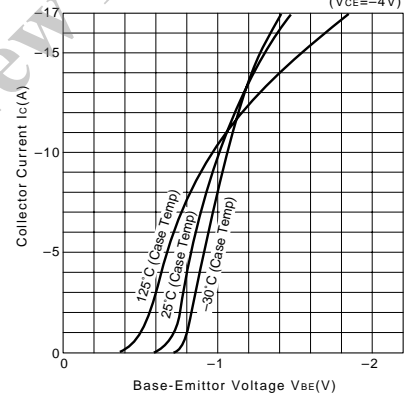

h<sub>FE</sub>-I<sub>C</sub> Characteristics (Typical)

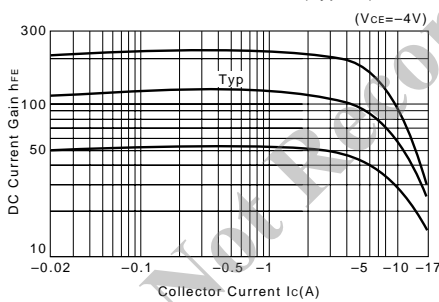

h<sub>FE</sub>-I<sub>C</sub> Temperature Characteristics (Typical)

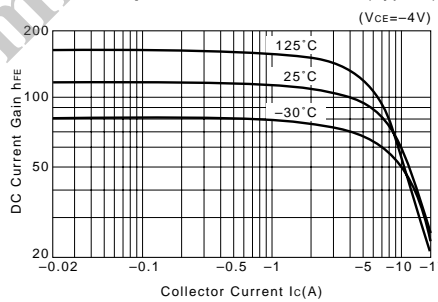

θ<sub>j-a</sub>-t Characteristics

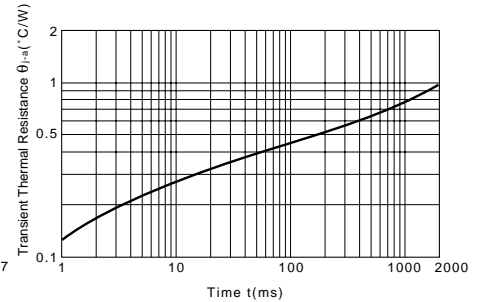

f<sub>T</sub>-I<sub>E</sub> Characteristics (Typical)

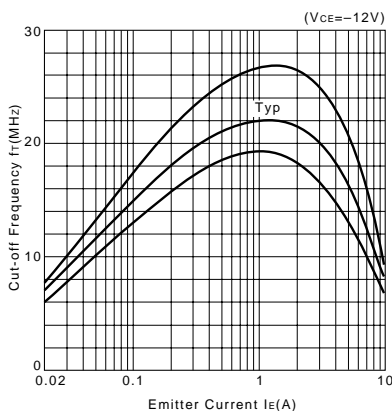

Safe Operating Area (Single Pulse)

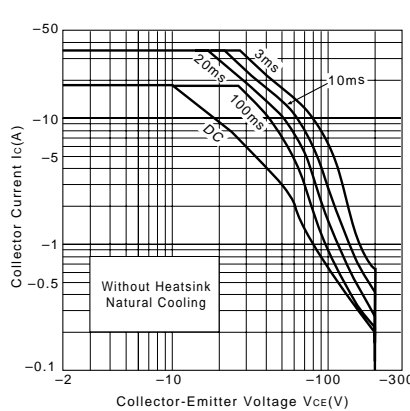

P<sub>C</sub>-T<sub>a</sub> Derating

