



Mini-Circuits

SURFACE MOUNT <sup>top hat</sup>

# Directional Coupler

## TCD-9-1W-75X+

75Ω

5 to 2000 MHz

### FEATURES

- Wideband, 5 to 2000 MHz
- Low mainline loss, 1.3 dB typ. (5-1000 MHz)
- Aqueous washable
- Leads for excellent solderability
- Protected by US Patent 6,140,887



Generic photo used for illustration purposes only

CASE STYLE: DB1627

### APPLICATIONS

- GPS
- Cellular
- Satellite distribution
- CATV

#### +RoHS Compliant

The +Suffix identifies RoHS Compliance. See our website for methodologies and qualifications

### ELECTRICAL SPECIFICATIONS AT 25°C

Parameter	Frequency (MHz)	Min.	Typ.	Max.	Unit
Frequency Range	—	5	—	2000	MHz
Mainline Loss <sup>1</sup> (above theoretical 0.1 dB)	5-50	—	1.3	2.1	dB
	50-500	—	1.3	2.0	
	500-1000	—	1.8	2.4	
	1000-2000	—	2.5	—	
Coupling	5-1000	—	8.9±0.5	—	dB
	1000-2000	—	8.5±0.5	—	
Coupling Flatness (±)	5-2000	—	±0.6	—	
Directivity	5-50	17	21	—	dB
	50-500	—	15	—	
	500-1000	—	10	—	
	1000-2000	—	10	—	
VSWR	5-1000	—	1.30	—	:1
	1000-2000	—	1.60	—	
Input Power	5-1000	—	—	0.5	W
	1000-2000	—	—	1.0	

1. Mainline loss includes theoretical power loss at coupled port.

### MAXIMUM RATINGS

Parameter	Ratings
Operating Temperature	-40°C to 85°C*
Storage Temperature	-55°C to 100°C

Permanent damage may occur if any of these limits are exceeded.  
\* Case temperature is defined as temperature on ground leads.

### ELECTRICAL SCHEMATIC

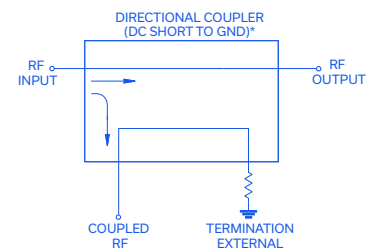

\*Electrical schematic is for Directional coupler with internal transformer(s) and external termination





# Directional Coupler

## TCD-9-1W-75X+

75Ω

5 to 2000 MHz

### PIN CONNECTIONS

INPUT	3
OUTPUT	4
COUPLED	1
GROUND	2
75Ω TERM EXTERNAL	6
NOT USED	5

**PRODUCT MARKING:** DL

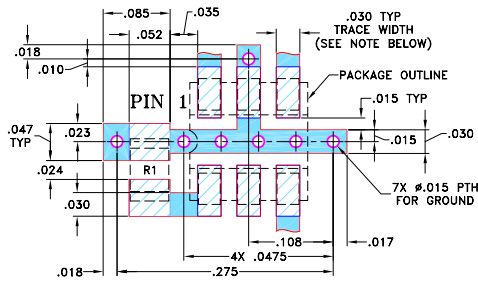

### DEMO BOARD MCL P/N: TB-72 SUGGESTED PCB LAYOUT (PL-010)



RESISTOR R1: 75 ± 1% Ohm, 0805 SIZE

**NOTES:** 1. TRACE WIDTH IS SHOWN FOR ROGERS R04350B WITH DIELECTRIC THICKNESS 0.030" ± 0.002"; COPPER: 1/2 OZ. EACH SIDE. FOR OTHER MATERIALS TRACE WIDTH MAY NEED TO BE MODIFIED.

2. BOTTOM SIDE OF THE PCB IS CONTINUOUS GROUND PLANE.

-  DENOTES PCB COPPER LAYOUT WITH SMOBC (SOLDER MASK OVER BARE COPPER)
-  DENOTES COPPER LAND PATTERN FREE OF SOLDER MASK

### OUTLINE DRAWING

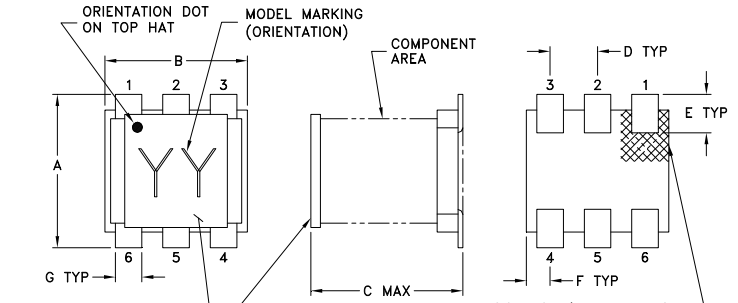

TOP-HAT / PICK & PLACE SURFACE AREA (10X.10) MIN  
TOP-HAT TOTAL THICKNESS: .013 inches MAX.

### PCB Land Pattern

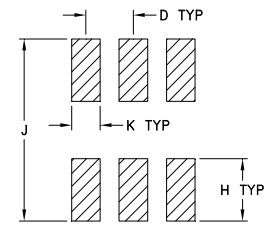

SUGGESTED LAYOUT TOLERANCE TO BE WITHIN ±.002

### OUTLINE DIMENSIONS (Inches mm)

A	B	C	D	E	F
.160	.150	.160	.050	.040	.025
4.06	3.81	4.06	1.27	1.02	0.64
G	H	J	K		wt
.028	.065	.190	.030		grams
0.71	1.65	4.83	0.76		0.15

### TAPE & REEL INFORMATION: F47



# Directional Coupler

## TCD-9-1W-75X+

75Ω

5 to 2000 MHz

### TYPICAL PERFORMANCE DATA

Frequency (MHz)	Mainline Loss (dB)		Coupling (dB)	Directivity (dB)	Return Loss (dB)		
	In-Out	In-Cpl			In	Out	Cpl
5.00	1.29	8.99	8.99	21.24	16.92	25.24	16.42
200.00	1.28	8.94	8.94	17.61	17.17	24.67	16.49
600.00	1.46	8.84	8.84	11.06	12.00	15.49	12.84
800.00	1.63	8.98	8.98	9.49	11.14	14.69	11.57
1000.00	1.87	8.81	8.81	8.59	11.05	14.44	10.62
1200.00	2.06	8.50	8.50	8.12	11.15	14.53	9.81
1400.00	2.27	8.43	8.43	7.88	11.16	14.51	9.22
1600.00	2.50	8.66	8.66	7.63	11.20	15.36	8.91
1800.00	2.71	9.00	9.00	7.19	11.56	15.46	8.40
2000.00	2.73	8.92	8.92	6.49	11.81	14.35	8.53

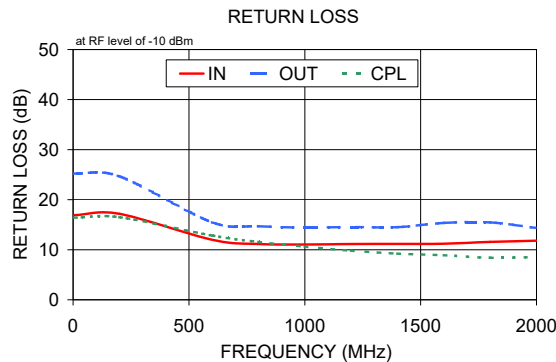
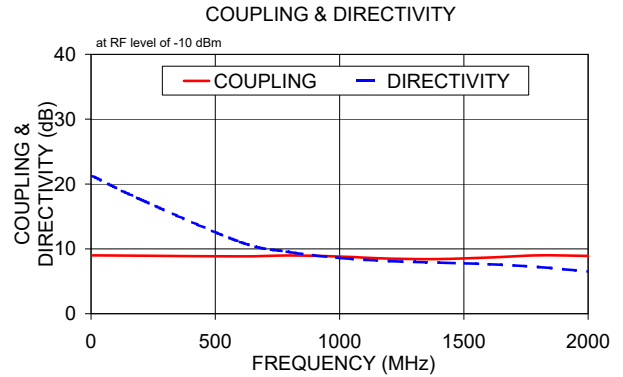
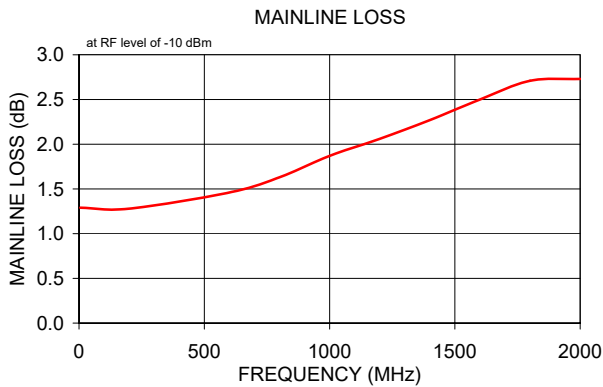

- NOTES**
- A. Performance and quality attributes and conditions not expressly stated in this specification document are intended to be excluded and do not form a part of this specification document.
  - B. Electrical specifications and performance data contained in this specification document are based on Mini-Circuit's applicable established test performance criteria and measurement instructions.
  - C. The parts covered by this specification document are subject to Mini-Circuits standard limited warranty and terms and conditions (collectively, "Standard Terms"); Purchasers of this part are entitled to the rights and benefits contained therein. For a full statement of the standard. Terms and the exclusive rights and remedies thereunder, please visit Mini-Circuits' website at [www.minicircuits.com/terms/viewterm.html](http://www.minicircuits.com/terms/viewterm.html)