

1/2" Flow Meter

Reads	Total flow and flow rate
Range	5.7 L/min – 75.70 L/min
Accuracy	+/- 10%
Connector	Tinned leads
Thread	1/2" Female NPT
Max pressure	100 PSI
Temperature range °C	-29 – 82 °C
Max viscosity	200 SSU
Cable length	69cm (27.1")
Voltage	4.0V – 24 VDC
Life expectancy	~10 years

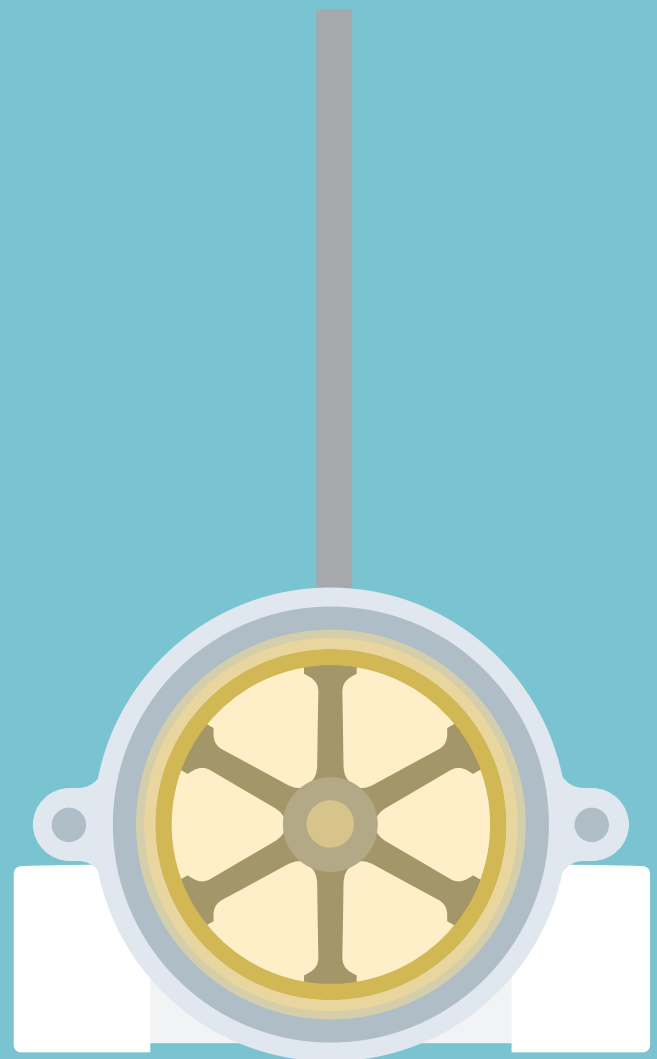

Measurements

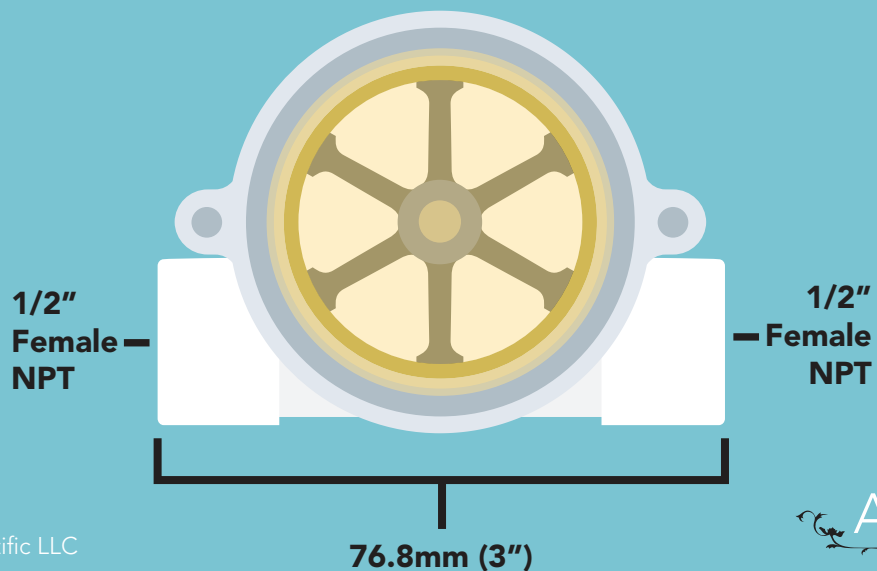
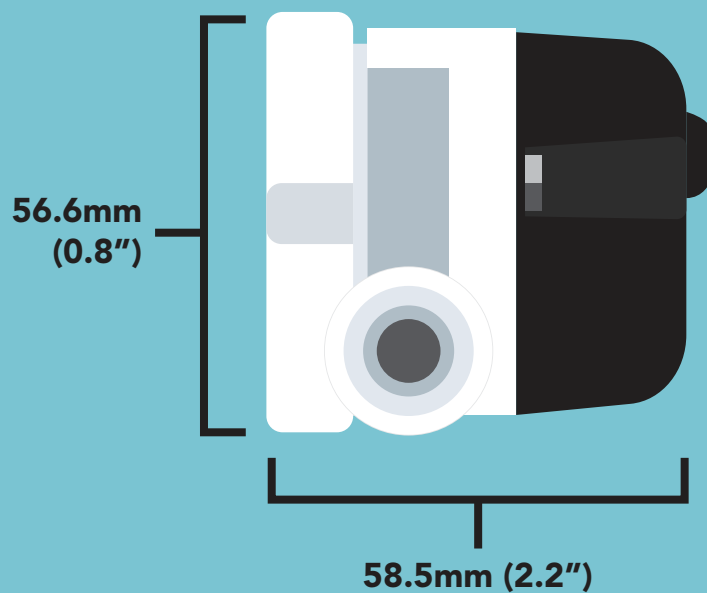
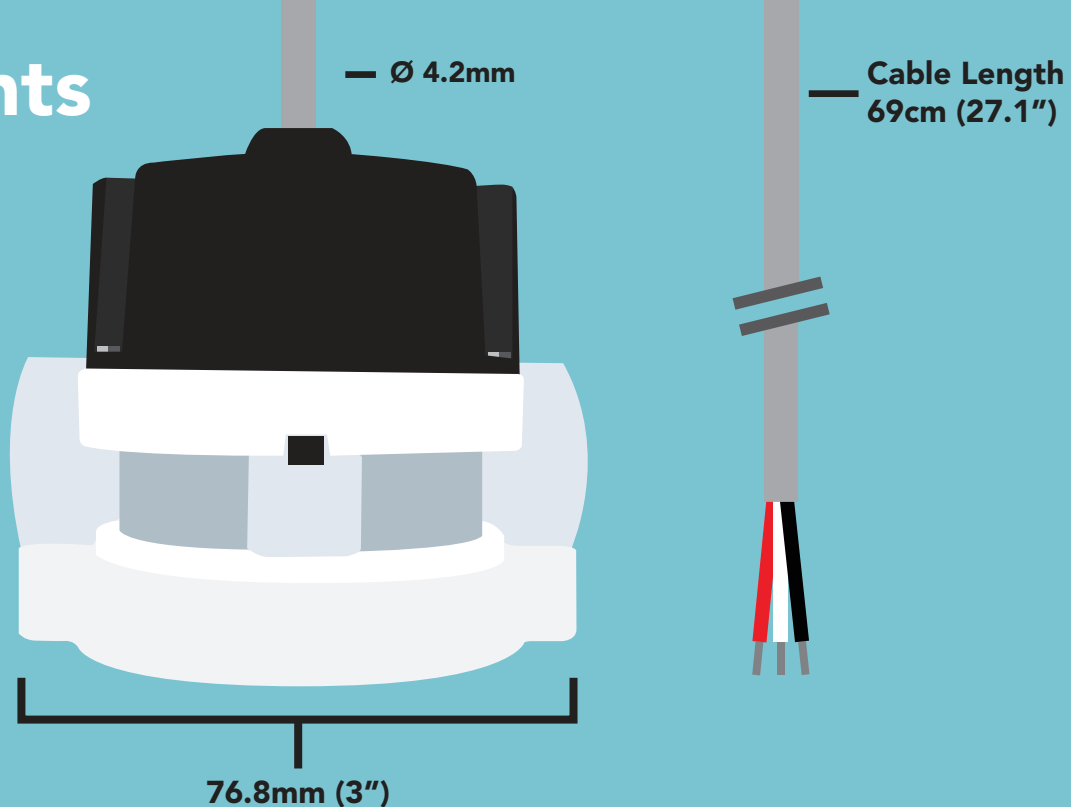

Wiring

The Atlas Scientific 1/2" Flow Meter has a 69cm (27.1") cable that terminates with three tinned leads; Red (VCC), White (Pulse), and Black (Ground).

Lead Color

RED

White

BLACK

Function

VCC 4.0V – 24V

PULSE

GND

Current consumption no load 8mA
Max current consumption 70mA

Microcontroller

PULSE

GND

VCC

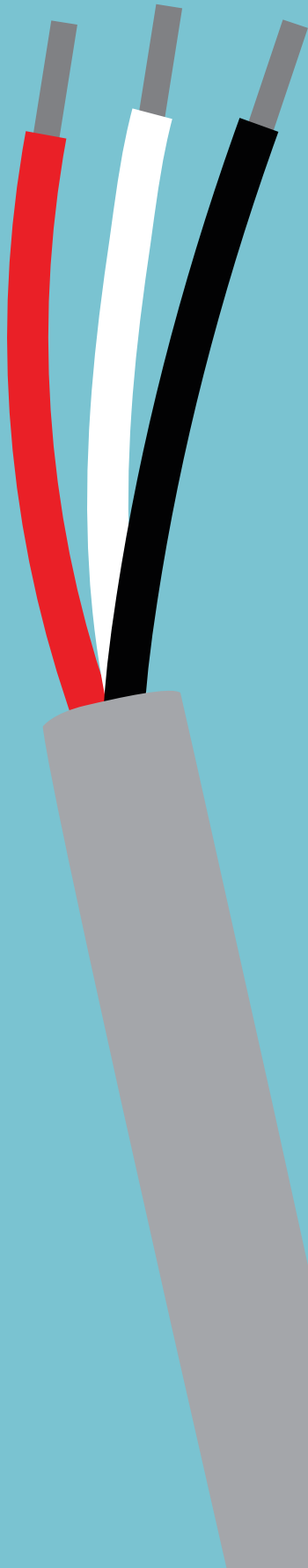

Specifications

Data output	Square wave
Max pressure	100 PSI
Max viscosity	200 SSU
Cable length	69 cm
Weight	104.3 grams
Food Safe	Yes
Gasoline Safe	Yes
Diesel Safe	Yes
Kerosene Safe	Yes

NSF/ANSI 61 Compliant

Atlas Scientific LLC, hereby certifies that,

1/2" Flow Meter
Part # Sen-204F

Complies with NSF/ANSI Standard 61

✓ **PVC**
NSF-61 Compliant

✓ **Buna-N**
NSF-61 Compliant

✓ **Ceramic**
NSF-61 Compliant

✓ **Polysulfone**
NSF-61 Compliant

✓ **Polypropylene**
NSF-61 Compliant

✓ **Polypropylene Sulfide**
NSF-61 Compliant

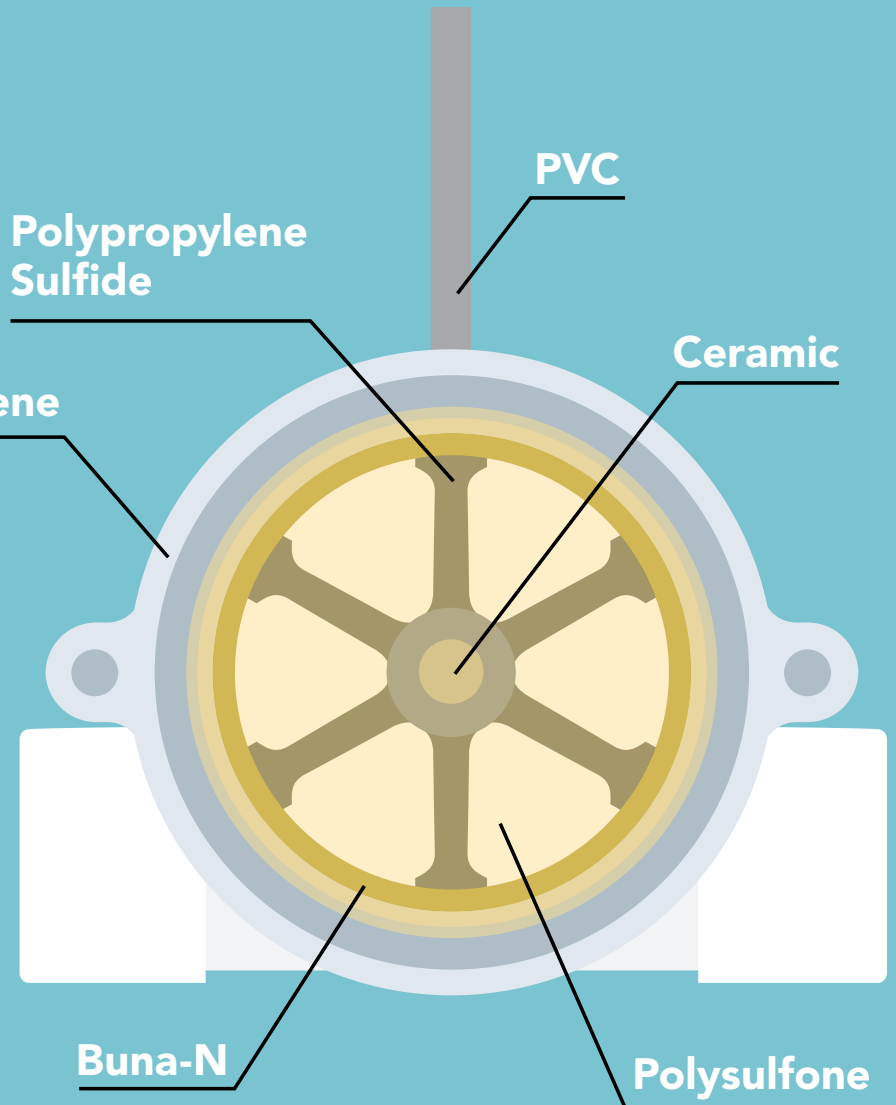

Operating principle

Paddle wheel flow meters like the Atlas Scientific 1/2" Flow Meter use frequency to calculate water flow. As water passes through the flow meter, the magnetic rotor spins at a rate proportional to the flow, producing a frequency. The relationship between water frequency and volume is not linear; an equation to convert the frequency to volume is found at the end of this document.

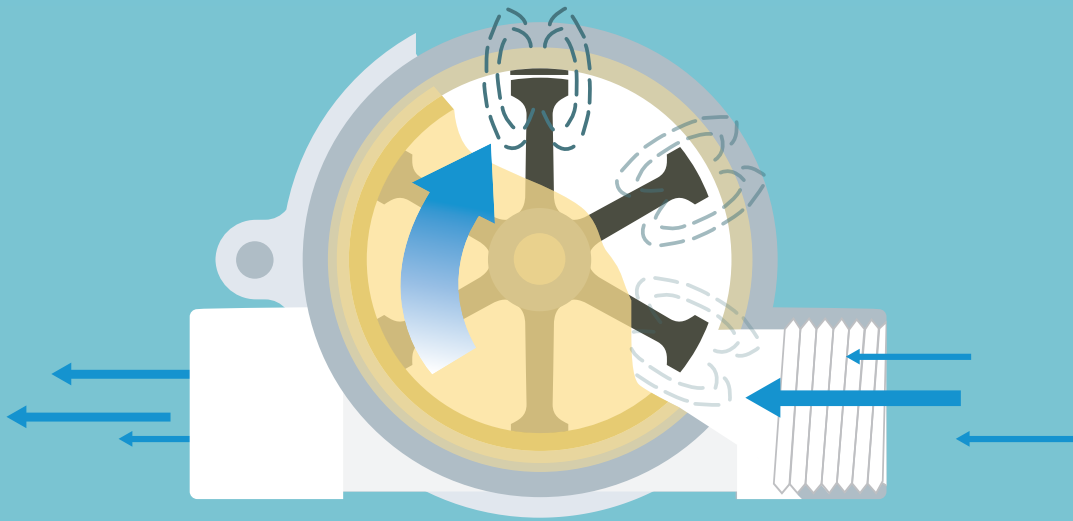

This flow meter is intended for medium-to-high flow ranges from 5.7 L/min (1.5GPM) up to 75.70 L/min (20 GPM).

Pre-filter requirements

If water with particulate matter will be passing through the flow meter, a pre-filter of at least **80 microns** must be used. Without the use of a pre-filter, the turbine blades can become jammed. Jammed turbine blades will not damage the flow meter; however, it will not be possible to get accurate flow readings until the blockage has been cleared.



3/4"
Pre-filter



1/2"
Pre-filter

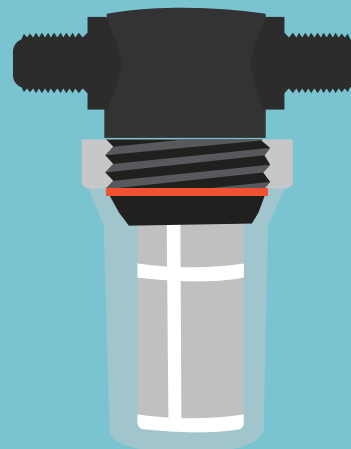

1/4"
Pre-filter

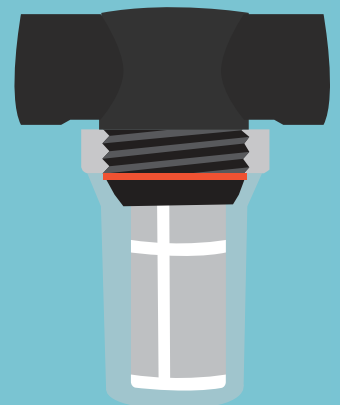

3/8"
Pre-filter

Laminar flow

Laminar flow can be thought of as the opposite of turbulent flow. In order for the flow meter to work properly, the liquid entering the flow meter should have a streamlined laminar flow. Achieving laminar flow is not hard to do; simply allow for 20cm (8") of straight pipe just before the liquid enters the flow meter.

Turbulent fluid entering the flow meter can cause inaccuracies in flow rate monitoring.

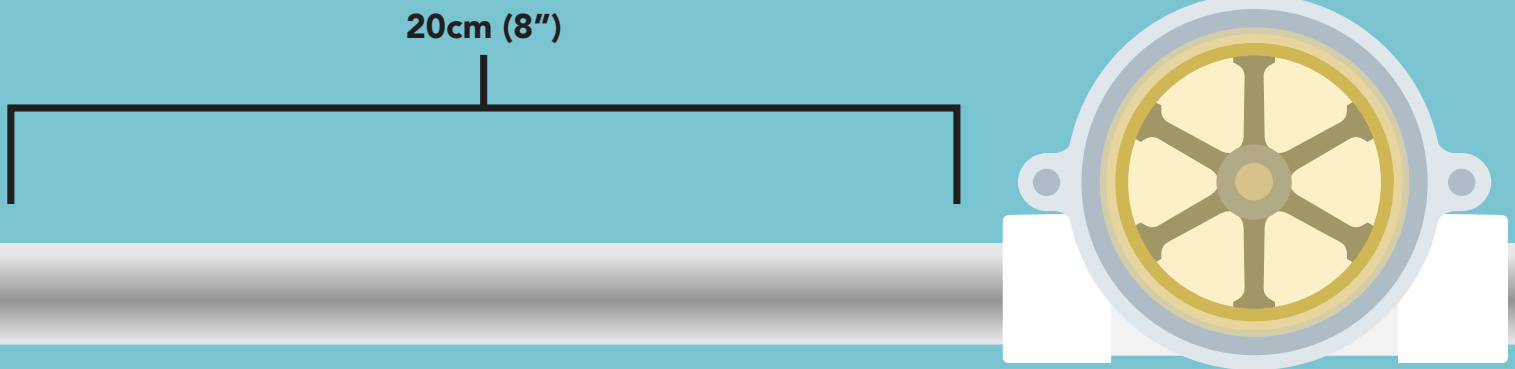

Laminar flow

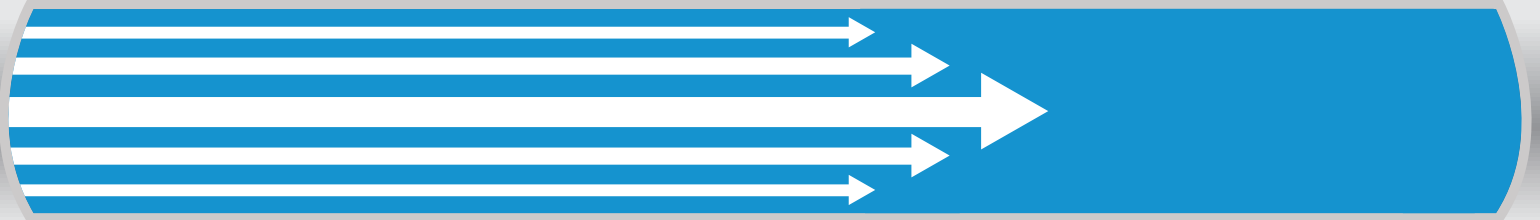

Turbulent flow

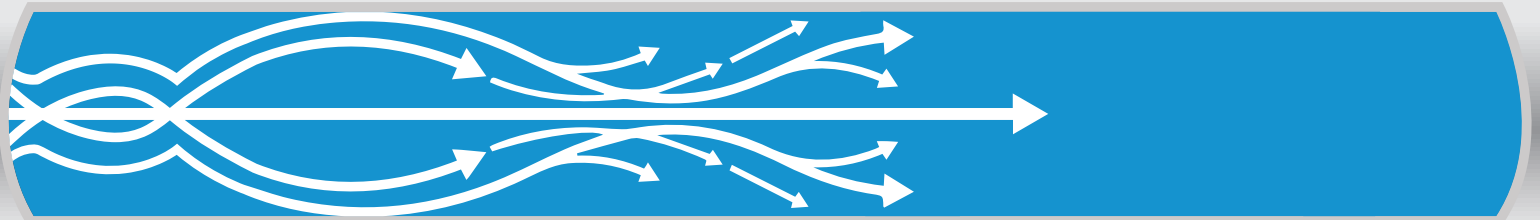

Liquid exiting the flow meter

Liquid should not be permitted to simply fall out of the flow meter. This would let air enter the flow meter and lead to inaccurate readings.

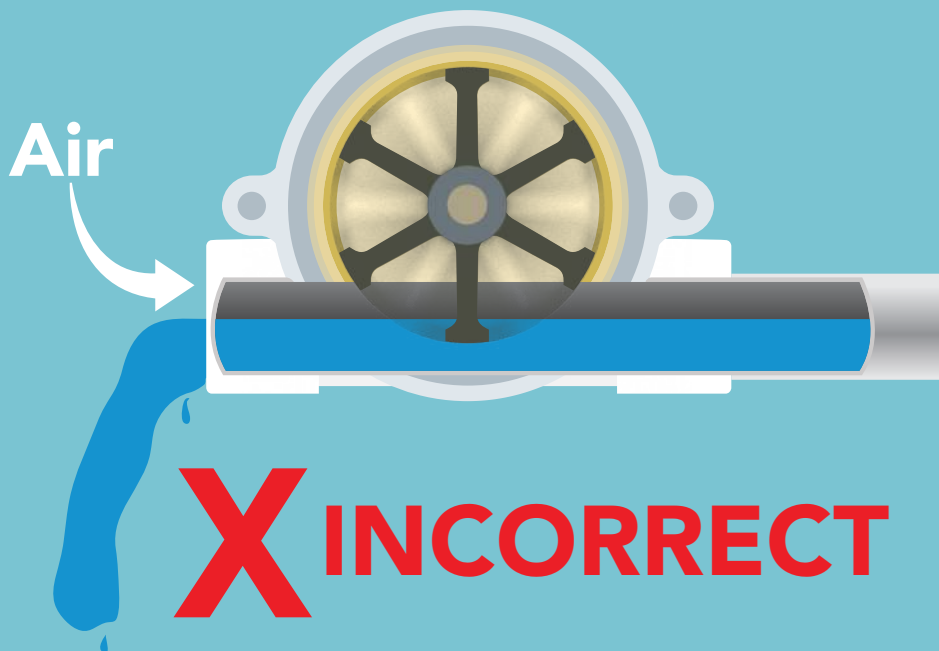

**FOR ACCURATE READINGS,
YOU CANNOT HAVE AIR IN
THE LINE.**

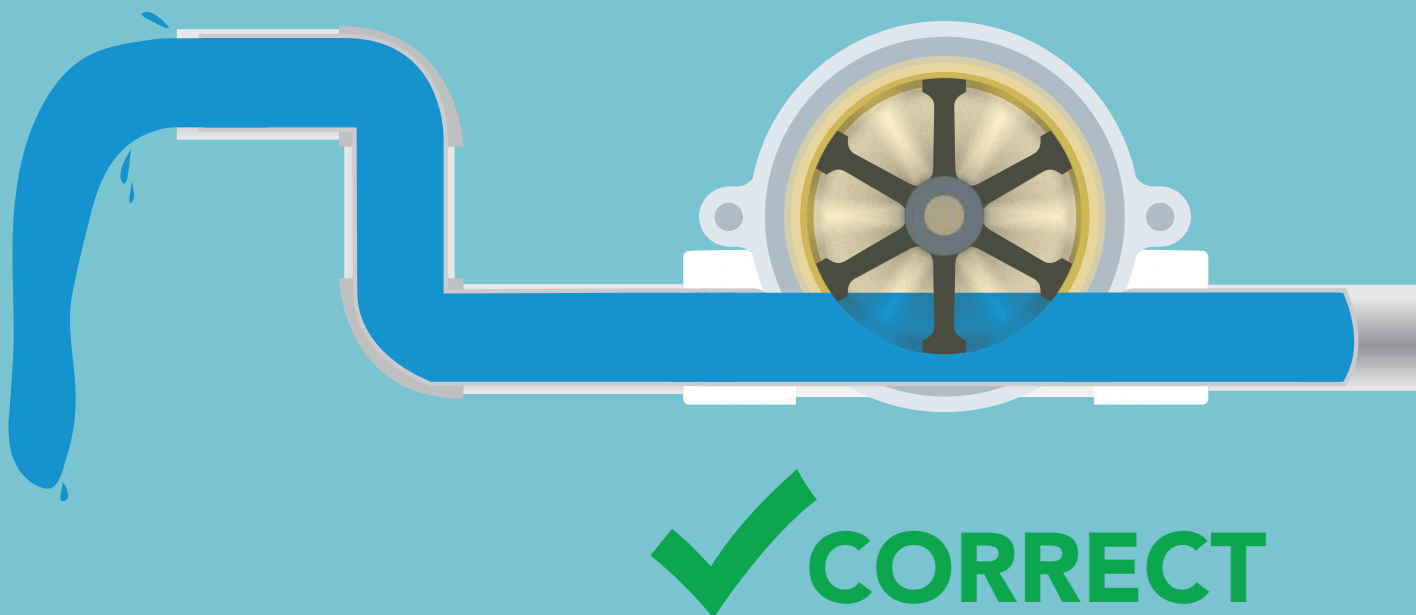

Low flow adapter

To monitor flow rates <15L/Min, use the low flow adapter included with the flow meter. Using the low flow adapter will limit your max flow rate to 45L/ min

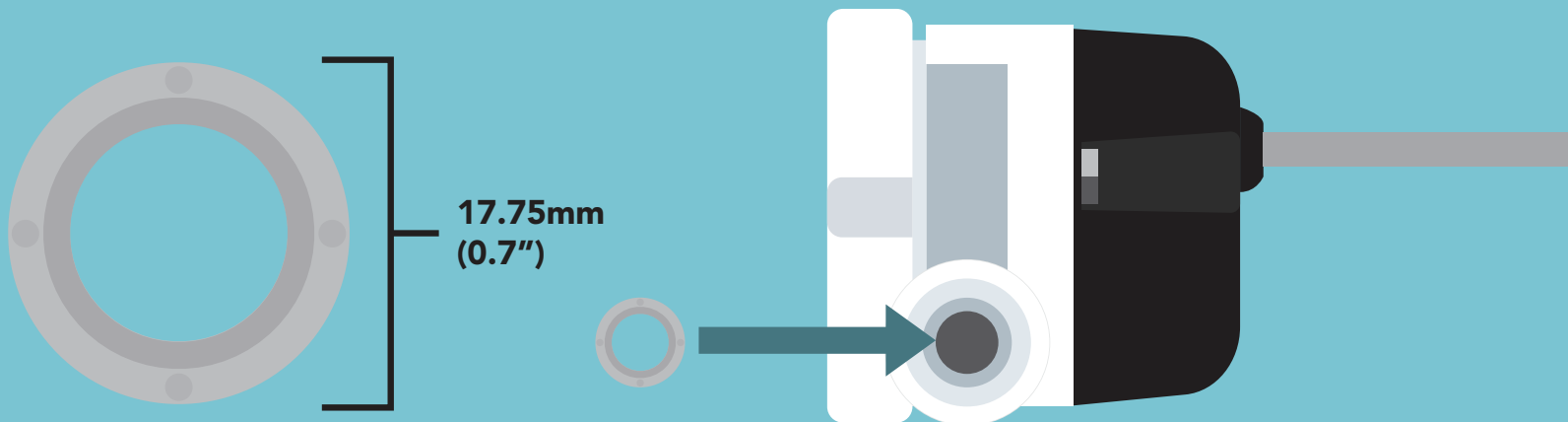

A low flow adapter is included with the Atlas Scientific 1/2" Flow Meter.

Data output

The white lead from the 1/2" Flow Meter will output a square wave frequency from 0 – 200+ Hz. The amplitude of the frequency will always equal the VCC. A single pulse is a rising edge followed by a falling edge.

EVENT

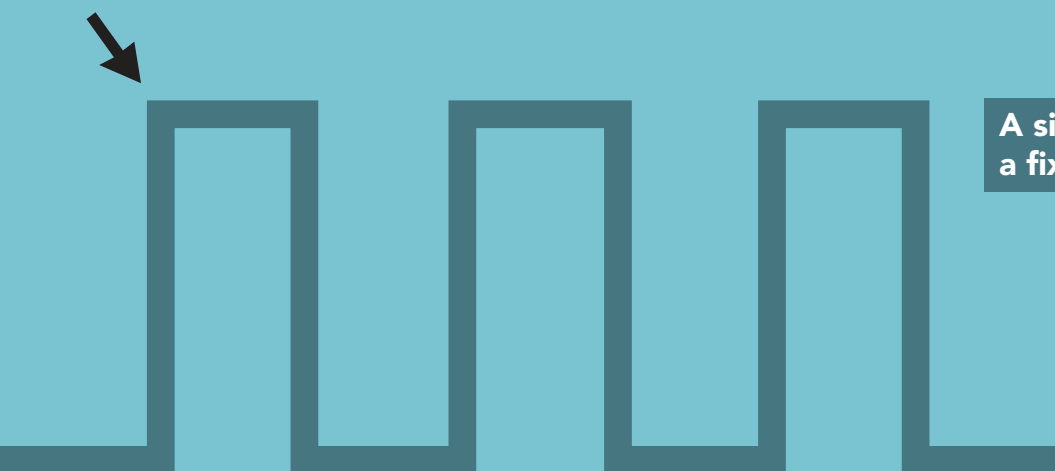

A single pulse does not represent a fixed volume a liquid.

The amount of liquid moving through the flow meter is quantified by the frequency that the flow meter outputs. This is known as the flow meters K-factor.

K-factor

As stated earlier, paddle wheel flow meters use frequency to calculate water flow. The relationship between frequency and volume is not linear. Here are the equations needed to calculate the volume.

1/2" Flow Meter with the low flow adapter installed

GPM	LPM	Output Frequency – Hz
------------	------------	------------------------------

1.5	5.7	17
2	7.6	25.9
2.5	9.5	34
3	11.4	43
4	15.2	60
5	19	76.6
6	22.8	94
7	26.6	111
8	30.4	129
9	34.2	147
10	38	165
11	41.8	185
12	45.6	204

$$\text{LPM} = 0.2152 \times [\text{Hz}] + 2.2928$$

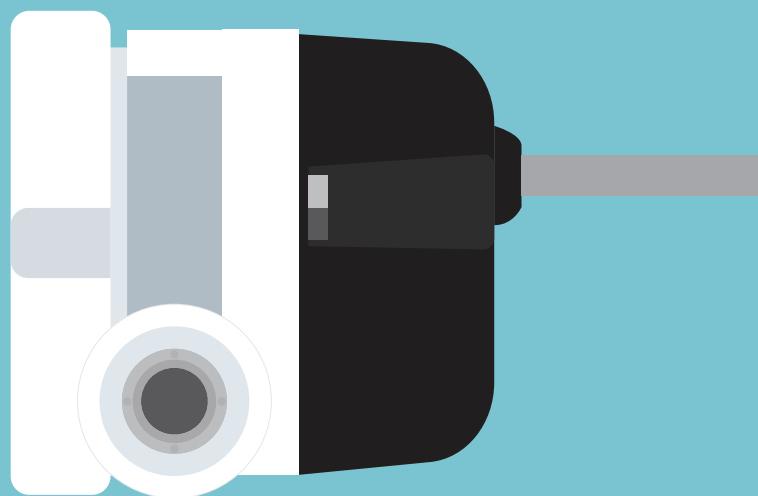

1/2" Flow Meter without the low flow adapter installed

GPM	LPM	Output Frequency – Hz
------------	------------	----------------------------------

4	15.2	34
5	19	44.8
6	22.8	55
7	26.6	65.9
8	30.4	76
9	34.2	87.5
10	38	99
11	41.8	110
12	45.6	122
13	49.4	135
14	53.2	147
15	57	158
16	60.8	170
17	64.6	183
18	68.4	195
19	72.2	207
20	76	220

$$\text{LPM} = 0.3256 \times [\text{Hz}] + 5.2004$$

