

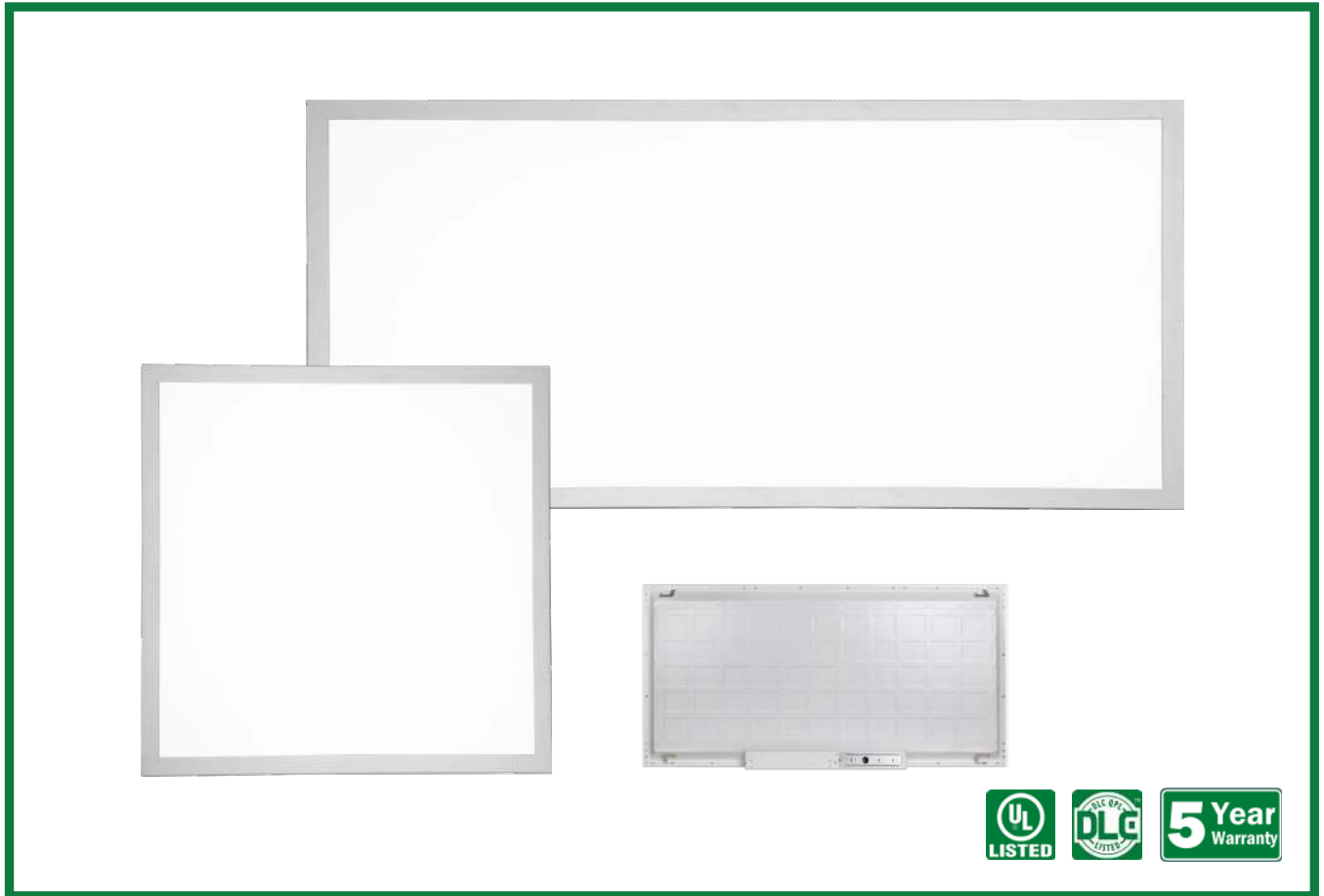

# Elite

## LED Flat Panel



### Elite

Beyond LED Elite Backlit panels offer uniform illumination and excellent energy savings. Our Elite panels deliver soft, glare-free, ambient lighting in a popular backlit design. Elite available in single CCT or Adjustable CCT & Adjustable Wattage. It is also available with a built-in Emergency Driver. The slim profile and energy-saving LED technology make the Elite the ideal choice for renovation or new construction.

- High efficacy, up to 130 Lm/W
- Wattage Adjustable 29/34/39/49W
- CCT Adjustable 3500/4000/5000K
- 0-10V Dimming capabilities
- Glare free lighting with remarkable light uniformity
- Super slim design with durable construction
- Optional hanging or surface mounting accessories available
- Built-in standard earthquake clips
- DLC Certified and 5 year warranty
- Universal 120-277 AC voltage (50-60Hz)

# Elite LED Flat Panel

## Elite

SKU #	Model #	Watts	Lumens	CCT	Length	Input Voltage	Certifications
151728	BLT-BPLED-2x2-39/D10/U/60/HL	39W	5150Lm	6000K	2X2'	120-277Vac	UL
152529	BLT-BPLED-2x4-49/D10/U/40/HL	49W	6468Lm	4000K	2X4'	120-277Vac	UL & DLC
152528	BLT-BPLED-2x4-49/D10/U/50/HL	49W	6517Lm	5000K	2X4'	120-277Vac	UL & DLC
151727	BLT-BPLED-2x4-49/D10/U/60/HL	49W	6450Lm	6000K	2X4'	120-277Vac	UL
151726	BLT-BPLED-2x4-29/34/39/49/ D10/U/35-40-50/HL	Wattage Adj. 29/34/39/49W	6449.60Lm	CCT Adjustable 3500K/4000K/5000K	2X4'	120-277Vac	UL & DLC
153585	BLT-BPLED-2x2-49/D10/U/50/HL	39W	5150Lm	5000K	2X2'	120-277Vac	UL & DLC
154199	BLT-BPLED-2x2-29/34/39/49WD10/ U/35-40-50/HL	29/34/39/49W	5150Lm	3500K/4000K/5000K	2X2'	120-277Vac	UL & DLC
151729	Surface Mounting Kit				2X4'	Optional	

## Specifications

<b>Voltage</b>	120-277 AC voltage (50-60Hz)
<b>Dimming</b>	0-10V Dimming capabilities
<b>Operating Temperature Range</b>	-4°F to 104°F
<b>Ceiling Type</b>	Exposed T-bar ceiling
<b>Light Source</b>	Non-replaceable LED
<b>CRI</b>	>80
<b>L70 / L90</b>	>75,000h / >40,000h

## CORRELATED COLOR TEMPERATURE (CCT)

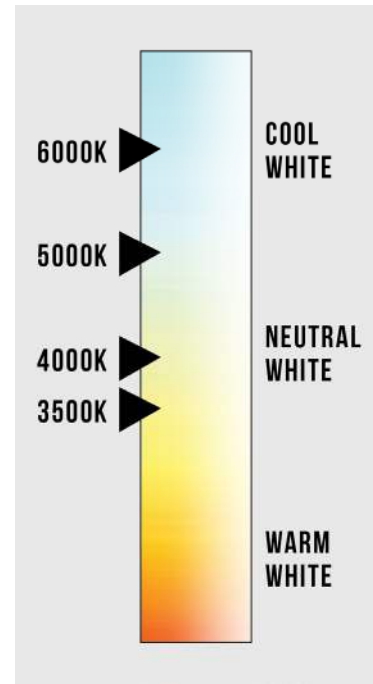

## Dimensions

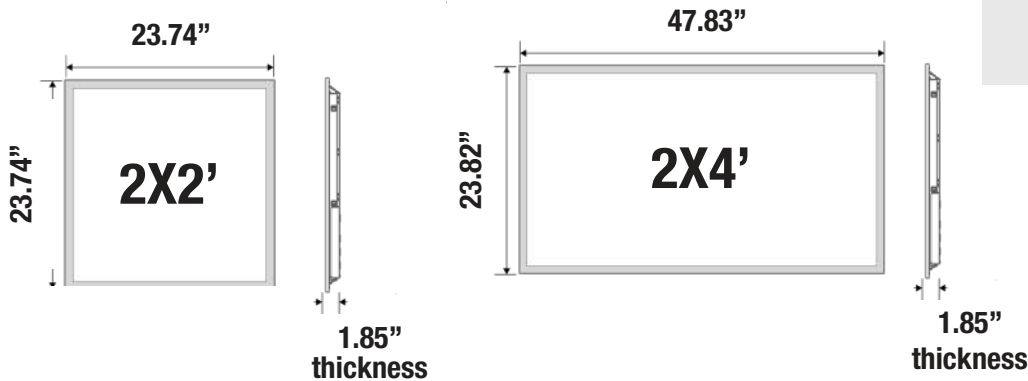

# Elite LED Flat Panel

## Distribution Diagram

### Electrical Measurement

Input Voltage (V)	Frequency (Hz)	Input Current (A)	Power (W)	Power Factor
120.0	60	0.409	48.94	0.998

### Photometric Measurement

Luminous Flux (lm)	Efficacy (lm/W)	$I_{max}$ (cd)	S/MH (C0/180)	S/MH (C90/270)
6450.5	131.85	2363.6	1.35	1.34

### Luminous Intensity Distribution

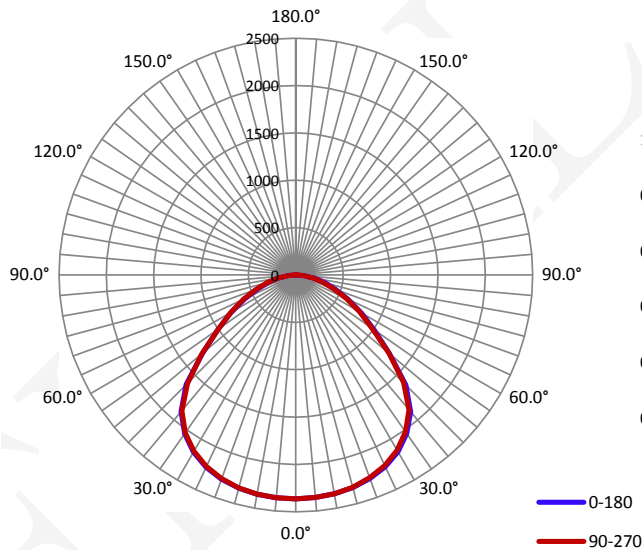

Relative Spectral Power Distribution

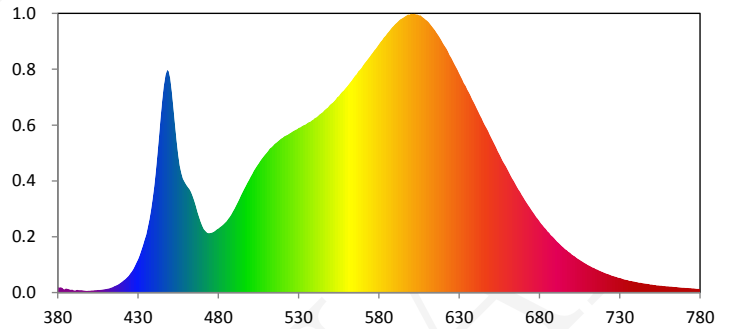

	C0/180	C45/225	C90/270	C135/315	AVG.
Beam Angle (50% $I_{max}$ ):	103.7	106.2	103.6	105.8	104.8
Field Angle (10% $I_{max}$ ):	156.7	158.5	156.0	158.5	157.4

### UGR Value

Reflectances:		
Ceiling (cavity)	0.7	
Wall	0.5	
Reference plane	0.2	
Room dimensions	Viewed crosswise	Viewed endwise
X=4H    Y=8H	19.1	18.7

# Elite LED Flat Panel

## Pre-Installation

### Mounting Options

Recessed

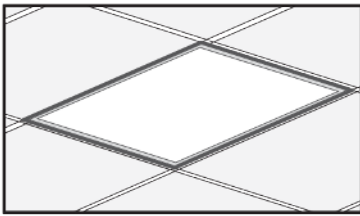

Surface  
(requires Mounting Kit)

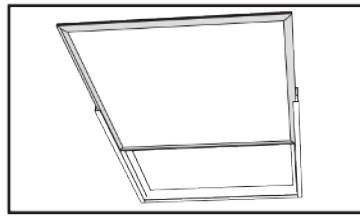

Pendant/Suspension  
(requires Mounting Kit)

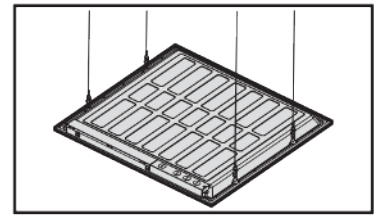

### Mounting Kit Description

#### Mounting Kit Description

4-Cable Suspension Kit

#### Mounting Kit Description

2x4 Surface

### Tools Required



Safety goggles

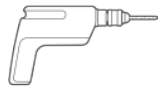

Drill



Ladder



Electrical tape



Phillips screwdriver



Flathead screwdriver



Wire cutters



Wire strippers

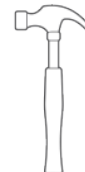

Hammer

### Hardware Included



AA - Wire nuts x5

### Before You Begin

1. Turn off the electricity at the circuit breaker or fuse box.
2. Choose your installation option:
  - Installation Option 1 - Flush Mount
  - Installation Option 2 - Surface Mount (Sold Separately)
  - Installation Option 3 - Pendant/Suspension Mount (Sold Separately)

(866) 786-1117 • [www.BeyondLEDTechnology.com](http://www.BeyondLEDTechnology.com)

Due to continuous product improvement, information in this document is subject to change.

# Elite

## LED Flat Panel

### Installation Options

#### FLUSH MOUNT INSTALLATION



**WARNING:** Before you begin, turn the power off at the circuit breaker or fuse box to avoid electric shock.

#### 1 Removing the ceiling panel

- a. Remove the plasterboard panel from the ceiling.

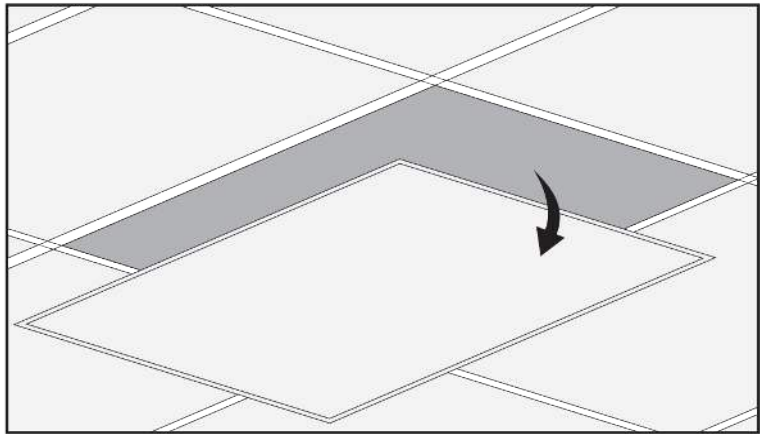

#### 2 Connecting the wires

- a. Lift the fixture to the ceiling.
- b. Follow the steps in the **Making the Electrical Connections** section of this manual.

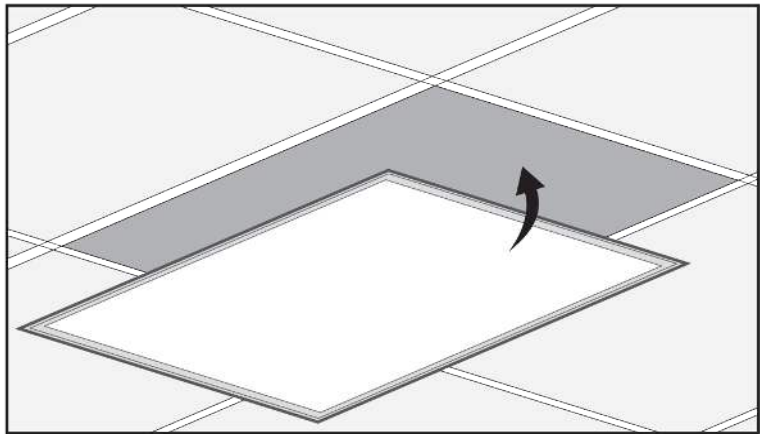

#### 3 Completing the installation

- a. Slide the fixture into place in the ceiling.
- b. Restore power to the fixture.

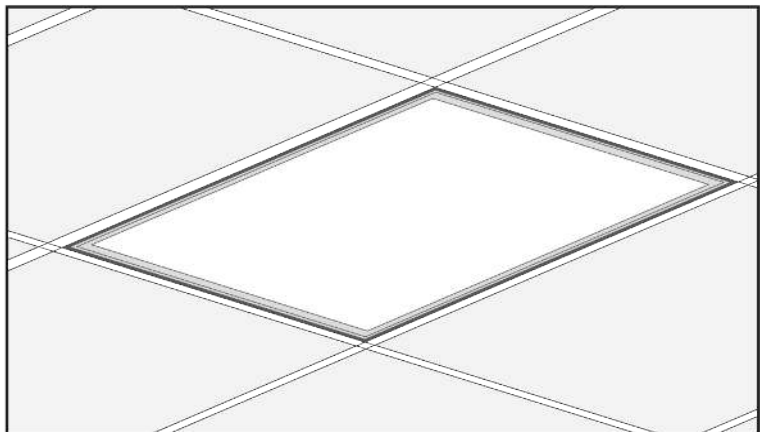

# Elite LED Flat Panel

## Mounting & Accessory Kits

### RECESSED INSTALLATION



1. Pull up the earthquake hook until it is perpendicular to the panel backing.(See picture 1)
2. Bend the hook arm until it is perpendicular to the hook body. (See picture 2)
3. Hook the panel to the T-Bar until it is full supported.(See picture 3)



Earthquake hook



# Elite LED Flat Panel

## Mounting & Accessory Kits

### T-BAR MOUNTING

Available for 2x4 versions only

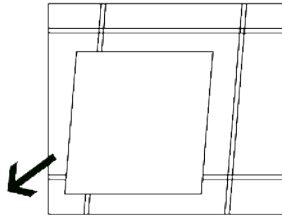

**1.** Remove the plaster board from the ceiling.

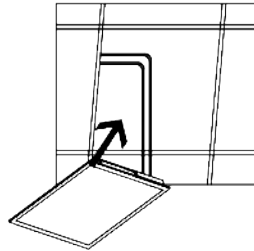

**2.** Fix the panel into ceiling.

\* T-bar mounting clips included  
\* Full installation instructions included

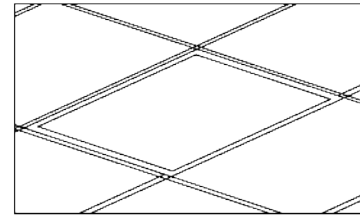

**3.** Installation finished.

### SURFACE MOUNTING KIT (OPTIONAL)

Available for 2x4 versions only

Accessory Parts List	Quantity	Size	Material
Screw A (KS 1X10)	8	0.04 inches diameter, 0.40 inches length	Zinc Coated Iron
Screw B (KA 4X25)	6	0.16 inches diameter, 0.98 inches length	Zinc Coated Iron
Expansion Bolt	6	0.24 inches diameter, 1.18 inches length	PVC
Frame	4	24.17 inches length, 2.44 inches height	Aluminum

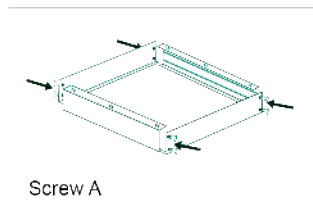
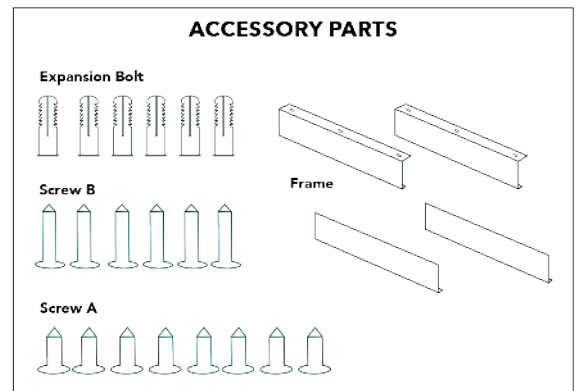

Screw A

**1.** Assemble the four sides with 2 X screw A each to create the frame.

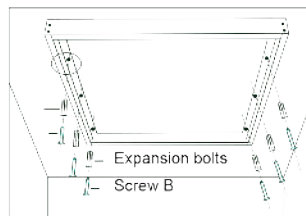

**2.** Fix the frame to the ceiling with screw B and expansion bolts.

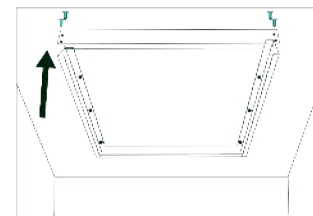

**3.** Once securely mounted to the ceiling disassemble one end (without mounting screws to the ceiling).

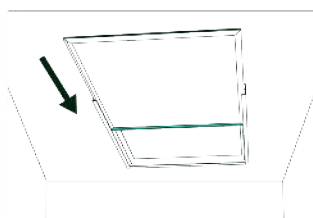

**4.** Insert the panel into the frame square.

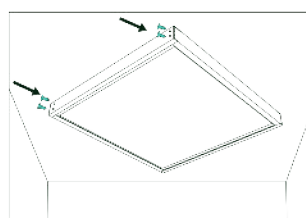

**5.** Reassemble the remaining end with screw A.

# Elite

## LED Flat Panel

### Mounting Kits

#### Optional Accessories



**Hanging Wire  
Suspension Mounting Kit**

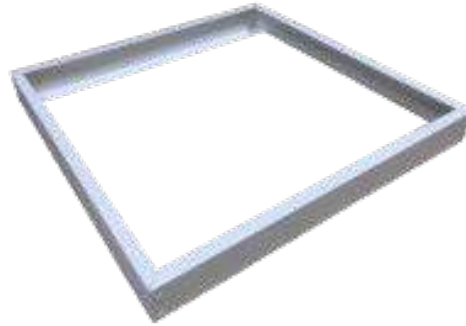

**SKU# 151729:  
2X4 Surface Mounting Kit**





# Elite

## LED Flat Panel

### Making the Electrical Connections



**WARNING:** Before you begin, turn the power off at the circuit breaker or fuse box to avoid electric shock.

#### 1 Open the junction box

- Unscrew and remove the junction box cover (1) from the fixture.

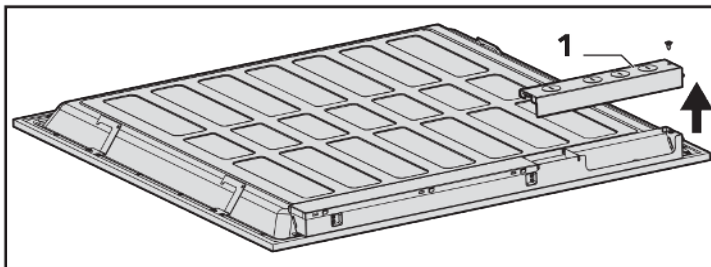

#### 2 Connect the supply wires

- Connect the green ground wire from the fixture to the supply ground wire.
- Connect the white wire from the fixture to the supply white wire (neutral wire).
- Connect the black wire from the fixture to the supply black wire (live wire).
- Secure the three connections using three wire nuts (AA).
- Wrap the three wire connections with electrical tape for a more secure connection.

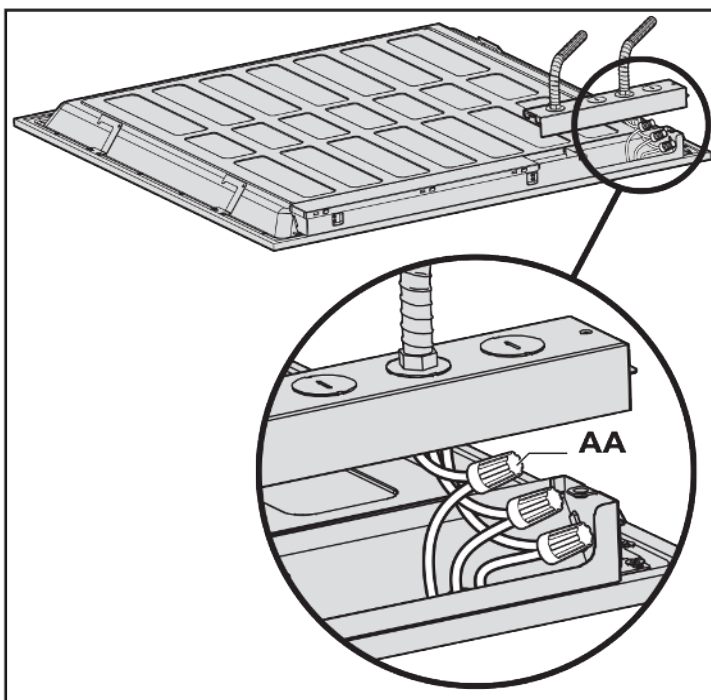

# Elite LED Flat Panel

## Making the Electrical Connections (continued)

### 3 Connect the dimming wires

- Connect the purple wire from the fixture to the purple (DIM+) supply wire.
- Connect the gray wire from the fixture to the gray (DIM-) supply wire.
- Secure the two connections using two wire nuts (AA).
- Wrap the two wire connections with electrical tape for a more secure connection.

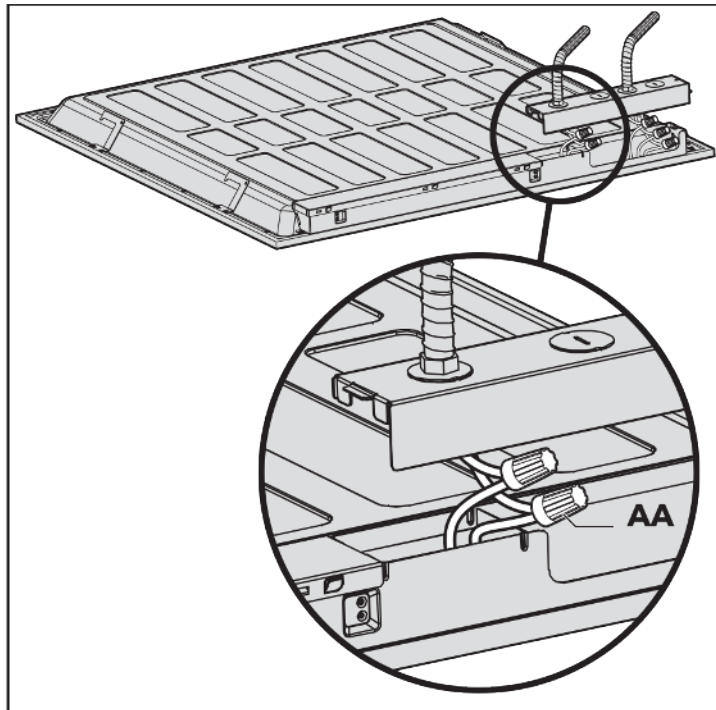

### 4 Reinstall the junction box cover

- Position the wires back inside the junction box.
- Reinstall the junction box cover (1).

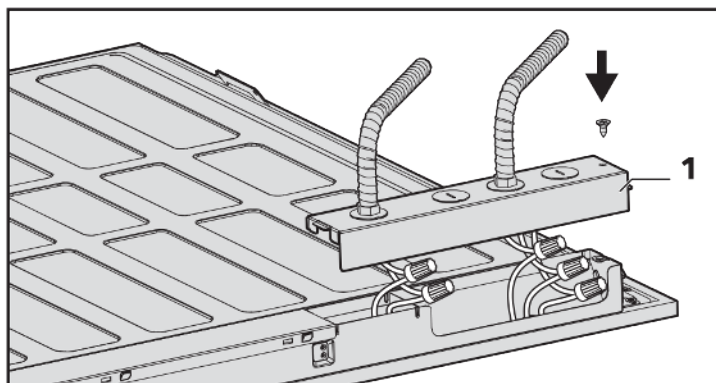

# Elite LED Flat Panel

## Safety Information



**IMPORTANT:** THIS PRODUCT MUST BE INSTALLED IN ACCORDANCE WITH THE APPLICABLE NATIONAL ELECTRICAL CODE AND LOCAL BUILDING CODES BY A PERSON FAMILIAR WITH THE CONSTRUCTION AND OPERATION OF THE PRODUCT AND THE HAZARDS INVOLVED.

SAVE THESE INSTRUCTIONS.



**WARNING:** Before installation or servicing, turn the power OFF at the circuit breaker or fuse. Place tape over the circuit breaker switch and verify power is OFF at the light fixture.



**WARNING:** Ground the fixture to avoid potential electric shock.



**WARNING:** Wear gloves when handling the fixture as edges are sharp.



**CAUTION:** Connect the fixture to a 120/277 Volt, 60 Hz power source. Any other connection voids the warranty.

**NOTICE:** FCC Regulations state that any unauthorized changes or modifications to this equipment not expressly approved by the manufacturer could void the user's authorization to operate this equipment.



**IMPORTANT:** The device is tested and found to comply with Part 15 of the FCC Rules. Operation is subject to two conditions: (1) This device may not cause harmful interference and, (2) this device must accept any interference received, including any interference that may cause undesired operation.

This equipment has been tested and found to comply with the limits for a Class A digital device, pursuant to Part 15 of the FCC rules. These limits are designed to provide reasonable protection against harmful interference when the equipment is operated in a commercial environment.

The equipment generates, uses, and can radiate radio frequency energy and, if not installed and used in accordance with the instruction manual, may cause harmful interference to radio communications. However, there is no guarantee that interference will not occur in a particular installation. If this equipment does cause harmful interference to radio or television reception, which can be determined by turning the equipment off and on, the user is encouraged to try to correct the interference by one or more of the following measures:

- Reorient or relocate the receiving antenna.
- Increase the separation between the equipment and receiver.
- Connect the equipment into an outlet on a circuit different from that to which the receiver is connected.
- Consult the dealer or an experienced radio/TV technician for help.

# Elite LED Flat Panel

## Packing

SKU #	Size	Pcs/Box	Dimensions	Weight	Pallet Quantity	Pallet Weight	Pallet Dimensions
151728	2X2	4	25"X26"X10"	23 Lbs.	120 Pcs	760 Lbs.	52"X50"X84"
151726	2X4	4	49"X26"X9"	41 Lbs.	60 Pcs	645 Lbs.	52"X50"X84"
151727	2X4	4	49"X26"X9"	41 Lbs.	60 Pcs	645 Lbs.	52"X50"X84"
152528	2X4	4	49"X26"X9"	41 Lbs.	60 Pcs	645 Lbs.	52"X50"X84"
152529	2X4	4	49"X26"X9"	41 Lbs.	60 Pcs	645 Lbs.	52"X50"X84"



LED FLAT PANELS