

THIS DRAWING IS UNPUBLISHED. RELEASED FOR PUBLICATION 20
 © COPYRIGHT 20 BY - ALL RIGHTS RESERVED.

REVISIONS					
P	LTR	DESCRIPTION	DATE	DWN	APVD
A		A REVISION RELEASE	6JUNE2022	SY	HL
B		UPDATE HARD TRAY IN SHEET6	24NOV2022	MC	HL

NOTES:

- 1 MATERIAL:
HOUSING: HIGH-TEMP PLASTIC; BLACK, UL 94V-0
CONTACT: COPPER ALLOY
SOLDER TAB: STAINLESS STEEL
- 2 FINISH:
(SEE TABLE) 0.1 INCH GOLD PLATING OR GOLD FLASH OVER PdNi ON CONTACT AREA.
2.54um MATTE-TIN PLATING ON SOLDER TAIL AREA.
1.27um NICKEL UNDERPLATING OVERALL.
- 3 PCIE5, PART NUMBER AND DC PRINTED IN APPROPRIATE AREA OR OPPOSITE
- 4 SUCH CORE VOIDS PER MANUFACTURER'S CONVENIENCE.
- 5 MATERIAL:
HOUSING: HIGH-TEMP PLASTIC; BLUE, UL 94V-0
CONTACT: COPPER ALLOY
SOLDER TAB: STAINLESS STEEL

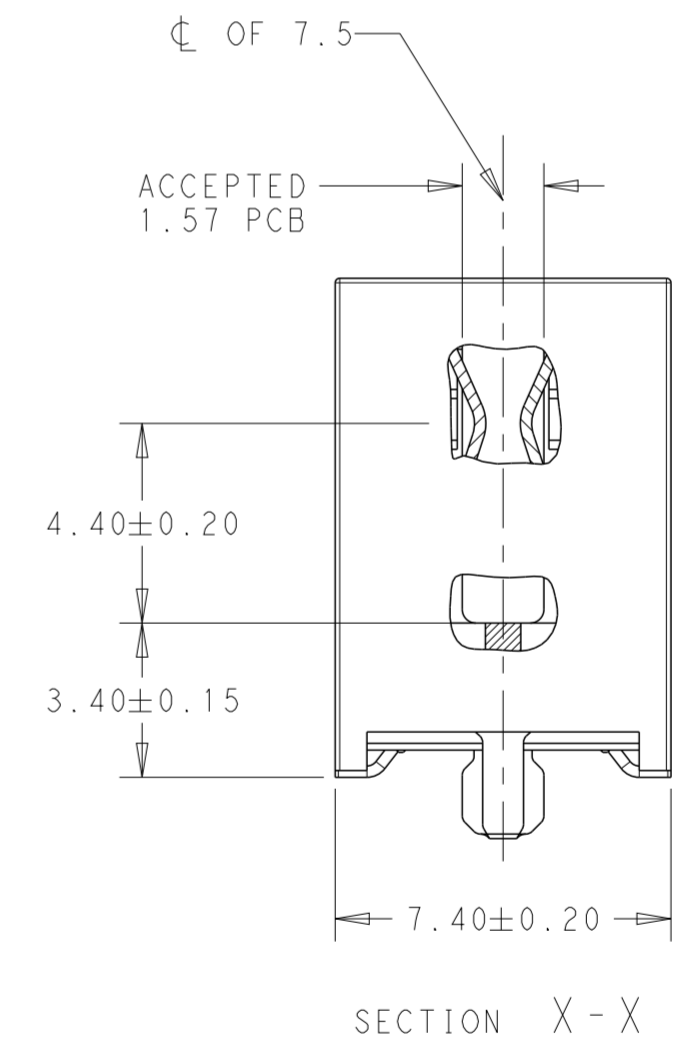
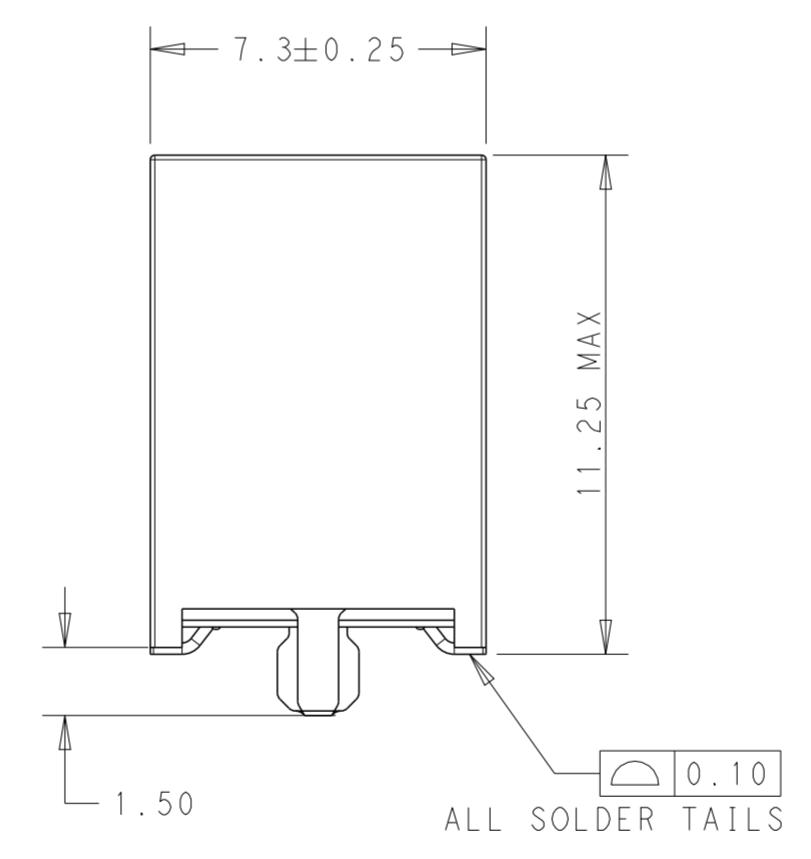
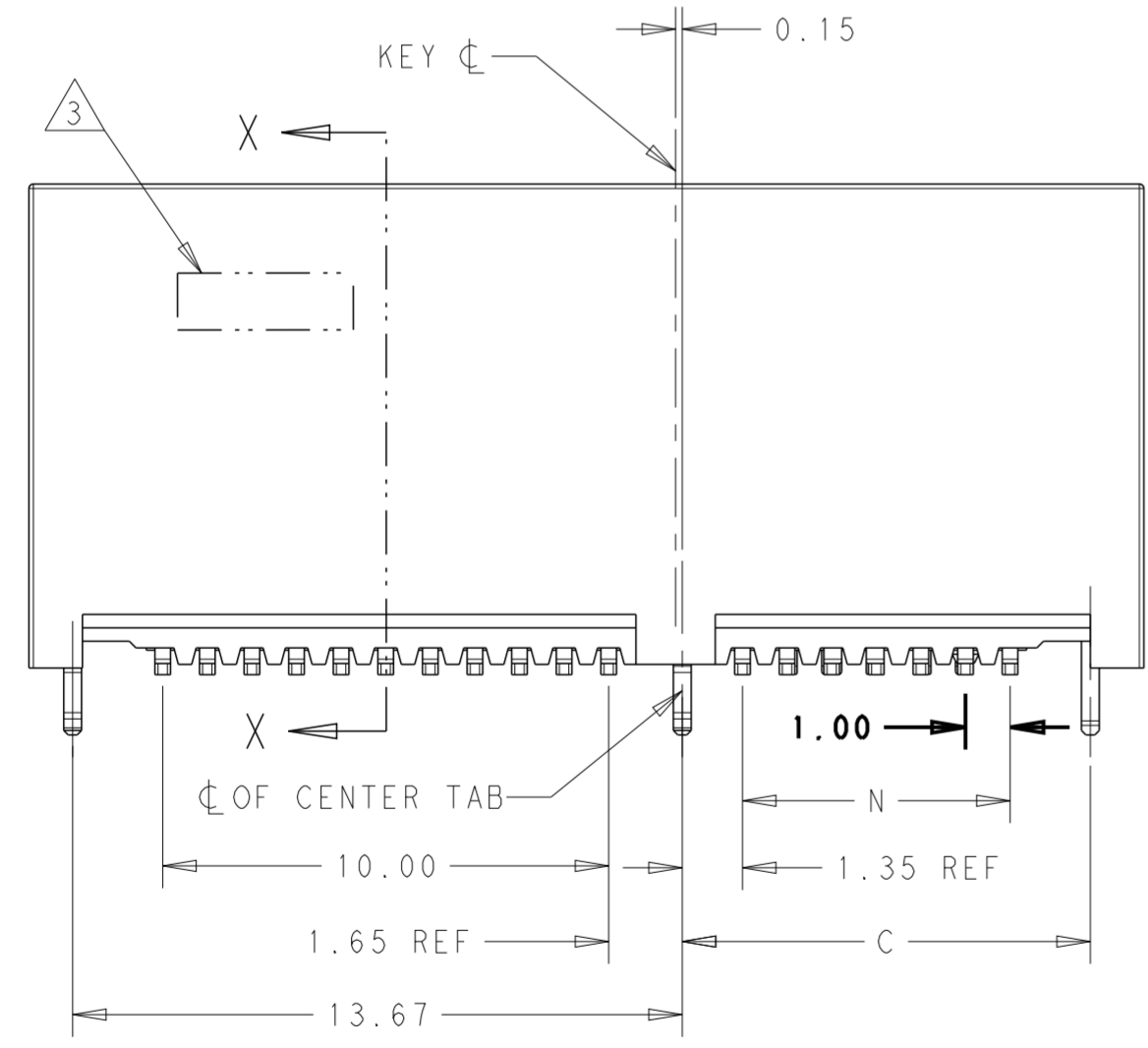
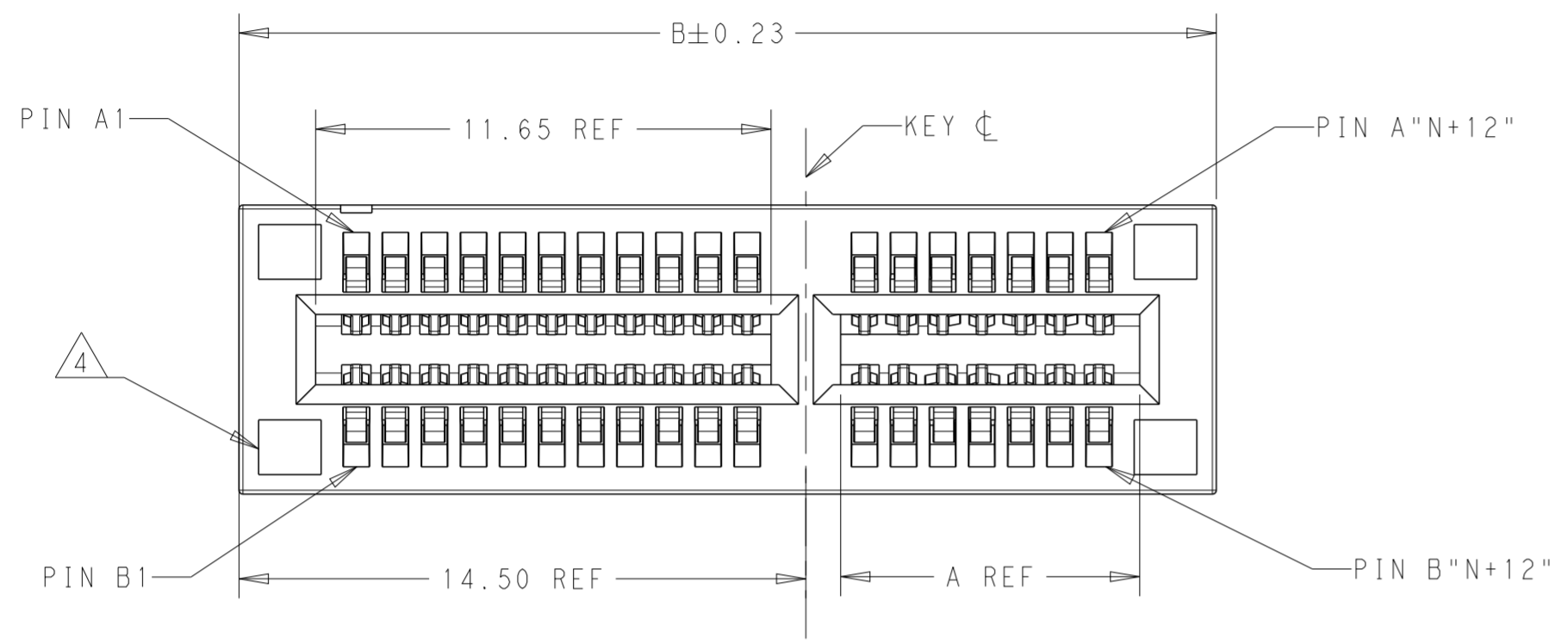

THIS DRAWING IS A CONTROLLED DOCUMENT.		DWN 08APR2020 SANDERS, YAN	STE TE Connectivity	
		CHK 08APR2020 MIKE, CHEN		
DIMENSIONS: mm		APVD 08APR2020 HOPE, LU	NAME PCI EXPRESS CARD EDGE CONNECTOR GEN5, 1.5 SOLDER TAB, WITHOUT RIDGE	
TOLERANCES UNLESS OTHERWISE SPECIFIED: 0 PLC ± 1 PLC ±0.3 2 PLC ±0.20 3 PLC ±0.050 4 PLC ± ANGLES ± FINISH		PRODUCT SPEC 108-160247	RESTRICTED TO	
MATERIAL - 1		APPLICATION SPEC -	SIZE A200779	DRAWING NO C-2371900
		WEIGHT -	SCALE 6:1	SHEET 1 OF 7
		CUSTOMER DRAWING	REV B	

THIS DRAWING IS UNPUBLISHED. RELEASED FOR PUBLICATION 20
 © COPYRIGHT 20 BY - ALL RIGHTS RESERVED.

REVISIONS				
P	LTR	DESCRIPTION	DATE	APVD
-		SEE SHEET 1	-	-

BLUE	HARD TRAY	323X136X19	30u"	86.5	8	44.5	70	73.15	89	71.65	164	8-2371900-8	5
BLACK	HARD TRAY	323X136X19	30u"	86.5	8	44.5	70	73.15	89	71.65	164	6-2371900-8	5
BLUE	HARD TRAY	330X235X19.3	30u"	86.5	8	44.5	70	73.15	89	71.65	164	7-2371900-8	5
BLACK	HARD TRAY	330X235X19.3	30u"	45.0	8	44.5	70	73.15	89	71.65	164	7-2371900-4	
BLACK	HARD TRAY	330X235X19.3	30u"	86.5	8	44.5	70	73.15	89	71.65	164	5-2371900-8	
BLACK	HARD TRAY	330X235X19.3	30u"	53.5	8	28	37	40.15	56	38.65	98	5-2371900-7	
BLACK	SOFT TRAY	338X235X20.3	30u"	36.5	8	19.5	20	23.15	39	21.65	64	5-2371900-6	
BLACK	SOFT TRAY	TBD	30u"	22.5	8	12.5	6	9.15	25	7.65	36	5-2371900-5	
BLACK	HARD TRAY	330X235X19.3	30u"	10.0	8	44.5	70	73.15	89	71.65	164	5-2371900-4	
BLACK	HARD TRAY	330X235X19.3	30u"	10.0	8	28	37	40.15	56	38.65	98	5-2371900-3	
BLACK	SOFT TRAY	338X235X20.3	30u"	10.0	8	19.5	20	23.15	39	21.65	64	5-2371900-2	
BLACK	SOFT TRAY	TBD	30u"	10.0	8	12.5	6	9.15	25	7.65	36	5-2371900-1	
BLACK	HARD TRAY	330X235X19.3	15u"	86.5	8	44.5	70	73.15	89	71.65	164	4-2371900-8	
BLACK	HARD TRAY	330X235X19.3	15u"	53.5	8	28	37	40.15	56	38.65	98	4-2371900-7	
BLACK	SOFT TRAY	338X235X20.3	15u"	36.5	8	19.5	20	23.15	39	21.65	64	4-2371900-6	
BLACK	SOFT TRAY	TBD	15u"	22.5	8	12.5	6	9.15	25	7.65	36	4-2371900-5	
BLACK	HARD TRAY	330X235X19.3	15u"	10.0	8	44.5	70	73.15	89	71.65	164	4-2371900-4	
BLACK	HARD TRAY	330X235X19.3	15u"	10.0	8	28	37	40.15	56	38.65	98	4-2371900-3	
BLACK	SOFT TRAY	338X235X20.3	15u"	10.0	8	19.5	20	23.15	39	21.65	64	4-2371900-2	
BLACK	SOFT TRAY	TBD	15u"	10.0	8	12.5	6	9.15	25	7.65	36	4-2371900-1	
BLACK	HARD TRAY	330X235X19.3	G/F	86.5	8	44.5	70	73.15	89	71.65	164	3-2371900-8	
BLACK	HARD TRAY	330X235X19.3	G/F	53.5	8	28	37	40.15	56	38.65	98	3-2371900-7	
BLACK	SOFT TRAY	338X235X20.3	G/F	36.5	8	19.5	20	23.15	39	21.65	64	3-2371900-6	
BLACK	SOFT TRAY	TBD	G/F	22.5	8	12.5	6	9.15	25	7.65	36	3-2371900-5	
BLACK	HARD TRAY	330X235X19.3	G/F	10.0	8	44.5	70	73.15	89	71.65	164	3-2371900-4	
BLACK	HARD TRAY	330X235X19.3	G/F	10.0	8	28	37	40.15	56	38.65	98	3-2371900-3	
BLACK	SOFT TRAY	338X235X20.3	G/F	10.0	8	19.5	20	23.15	39	21.65	64	3-2371900-2	
BLACK	SOFT TRAY	TBD	G/F	10.0	8	12.5	6	9.15	25	7.65	36	3-2371900-1	
BLACK	HARD TRAY	330X235X19.3	30u"		NA	44.5	70	73.15	89	71.65	164	2-2371900-4	
BLACK	HARD TRAY	330X235X19.3	30u"		NA	28	37	40.15	56	38.65	98	2-2371900-3	
BLACK	SOFT TRAY	338X235X20.3	30u"		NA	19.5	20	23.15	39	21.65	64	2-2371900-2	
BLACK	SOFT TRAY	TBD	30u"		NA	12.5	6	9.15	25	7.65	36	2-2371900-1	
BLACK	HARD TRAY	330X235X19.3	15u"		NA	44.5	70	73.15	89	71.65	164	1-2371900-4	
BLACK	HARD TRAY	330X235X19.3	15u"		NA	28	37	40.15	56	38.65	98	1-2371900-3	
BLACK	SOFT TRAY	338X235X20.3	15u"		NA	19.5	20	23.15	39	21.65	64	1-2371900-2	
BLACK	SOFT TRAY	TBD	15u"		NA	12.5	6	9.15	25	7.65	36	1-2371900-1	
BLACK	HARD TRAY	330X235X19.3	G/F		NA	44.5	70	73.15	89	71.65	164	2371900-4	
BLACK	HARD TRAY	330X235X19.3	G/F		NA	28	37	40.15	56	38.65	98	2371900-3	
BLACK	SOFT TRAY	338X235X20.3	G/F		NA	19.5	20	23.15	39	21.65	64	2371900-2	
BLACK	SOFT TRAY	TBD	G/F		NA	12.5	6	9.15	25	7.65	36	2371900-1	
COLOR	TYPE	L * W * H (TRAY)	PRECIOUS PLATING THICKNESS (TOTAL)	W	V	J	N	C	B	A	POS.	PART NUMBER	
	PACKAGE			MYLAR SIZE (PAGE 4)									

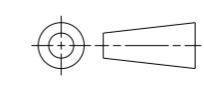
THIS DRAWING IS A CONTROLLED DOCUMENT.		DWN SANDERS YAN 08APR2020	 TE Connectivity	
DIMENSIONS: mm		CHK MIKE CHEN 08APR2020		
		APVD HOPE LU 08APR2020	NAME PCI EXPRESS CARD EDGE CONNECTOR GEN5, 1.5 SOLDER TAB, WITHOUT RIDGE	
TOLERANCES UNLESS OTHERWISE SPECIFIED:		PRODUCT SPEC 108-160247	SIZE CAGE CODE DRAWING NO RESTRICTED TO	
0 PLC ±0.3		APPLICATION SPEC	A200779 C-2371900	
1 PLC ±0.20		WEIGHT	SCALE 6:1 SHEET 2 OF 7 REV B	
2 PLC ±0.050		CUSTOMER DRAWING		
3 PLC ±0.050				
4 PLC ±				
ANGLES ±				
FINISH				

THIS DRAWING IS UNPUBLISHED. RELEASED FOR PUBLICATION 20
 © COPYRIGHT 20 BY - ALL RIGHTS RESERVED.

REVISIONS				
P	LTR	DESCRIPTION	DATE	APVD
-	-	SEE SHEET 1	-	-

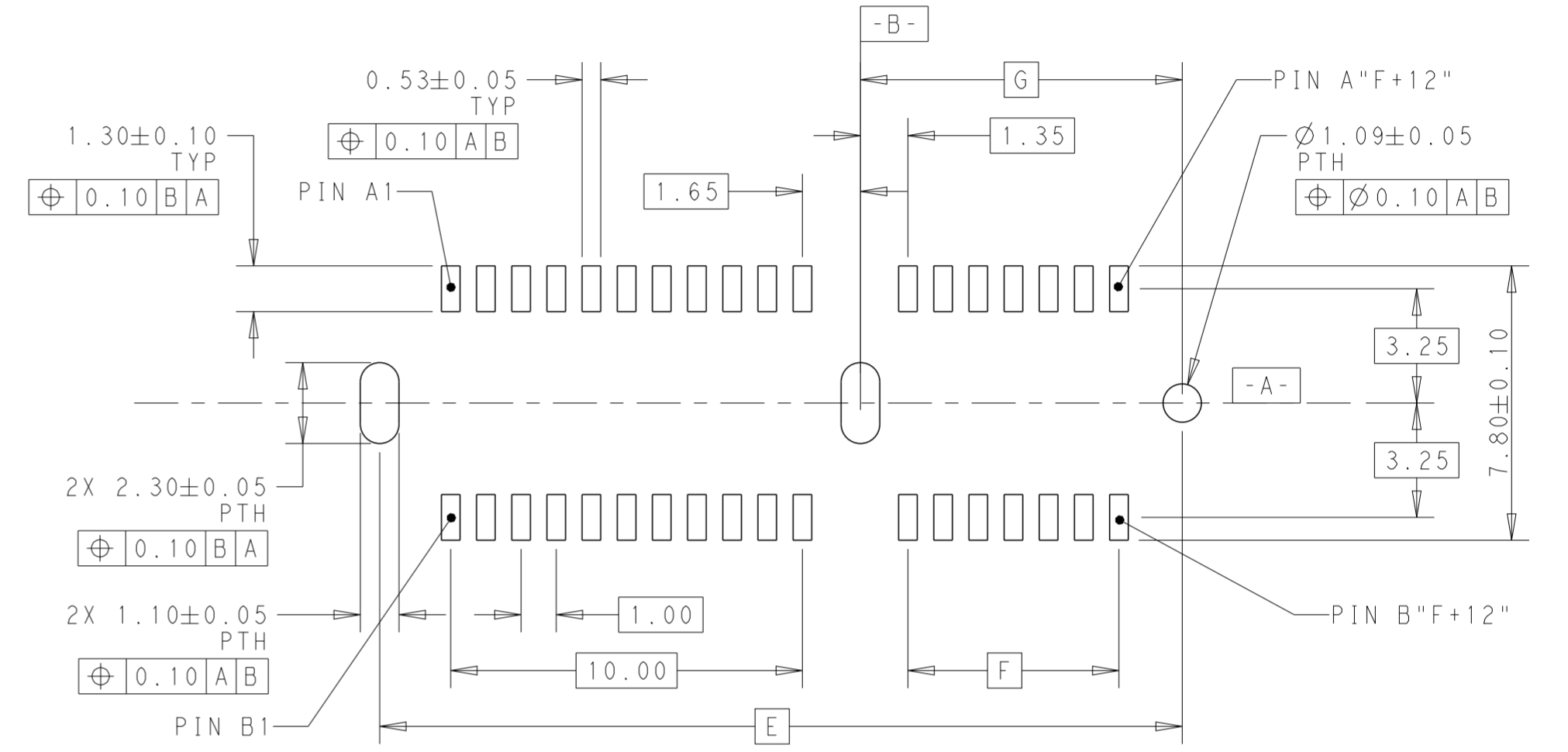
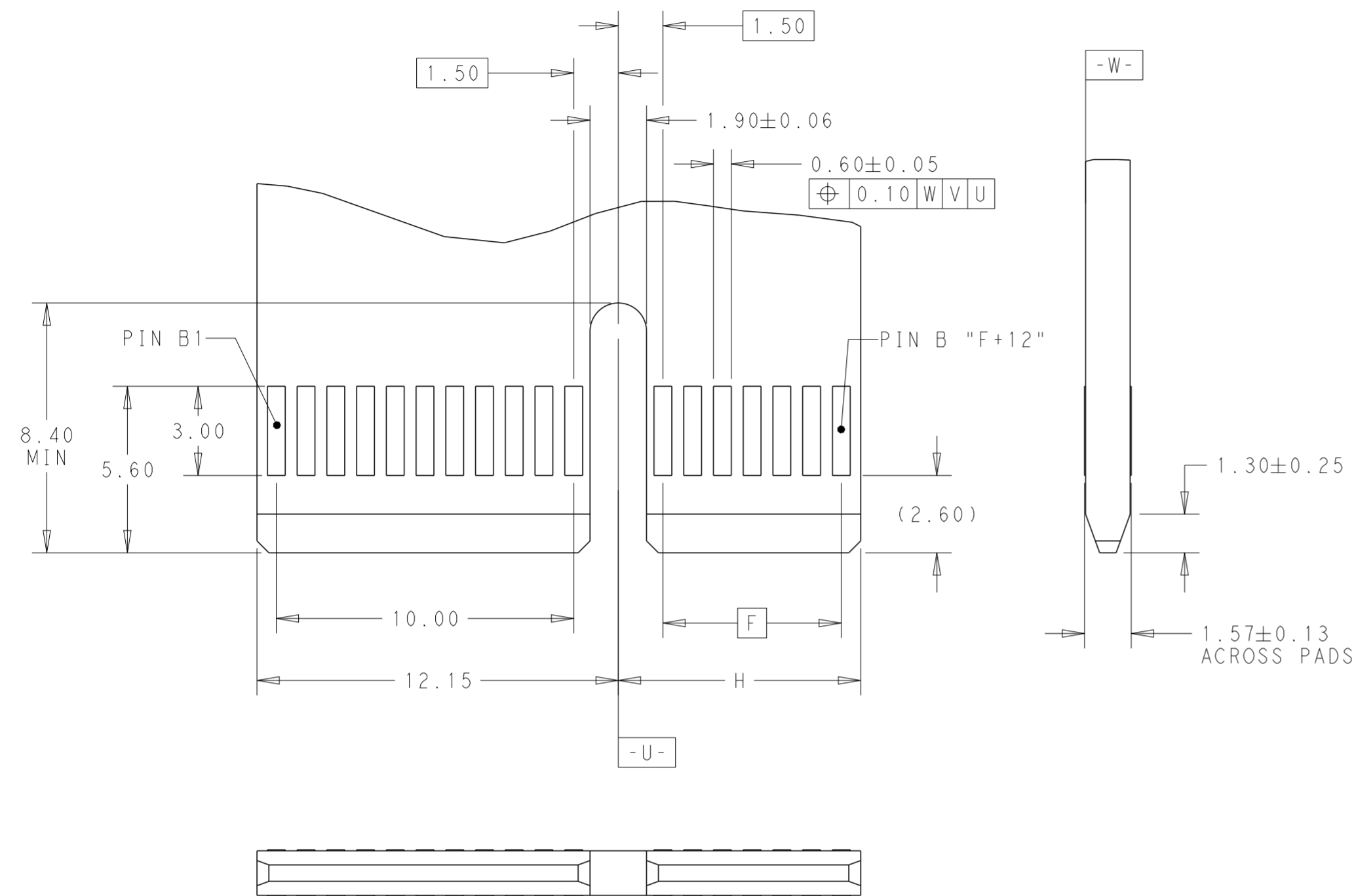

RECOMMENDED PCB LAYOUT (36POS AS SHOWN)

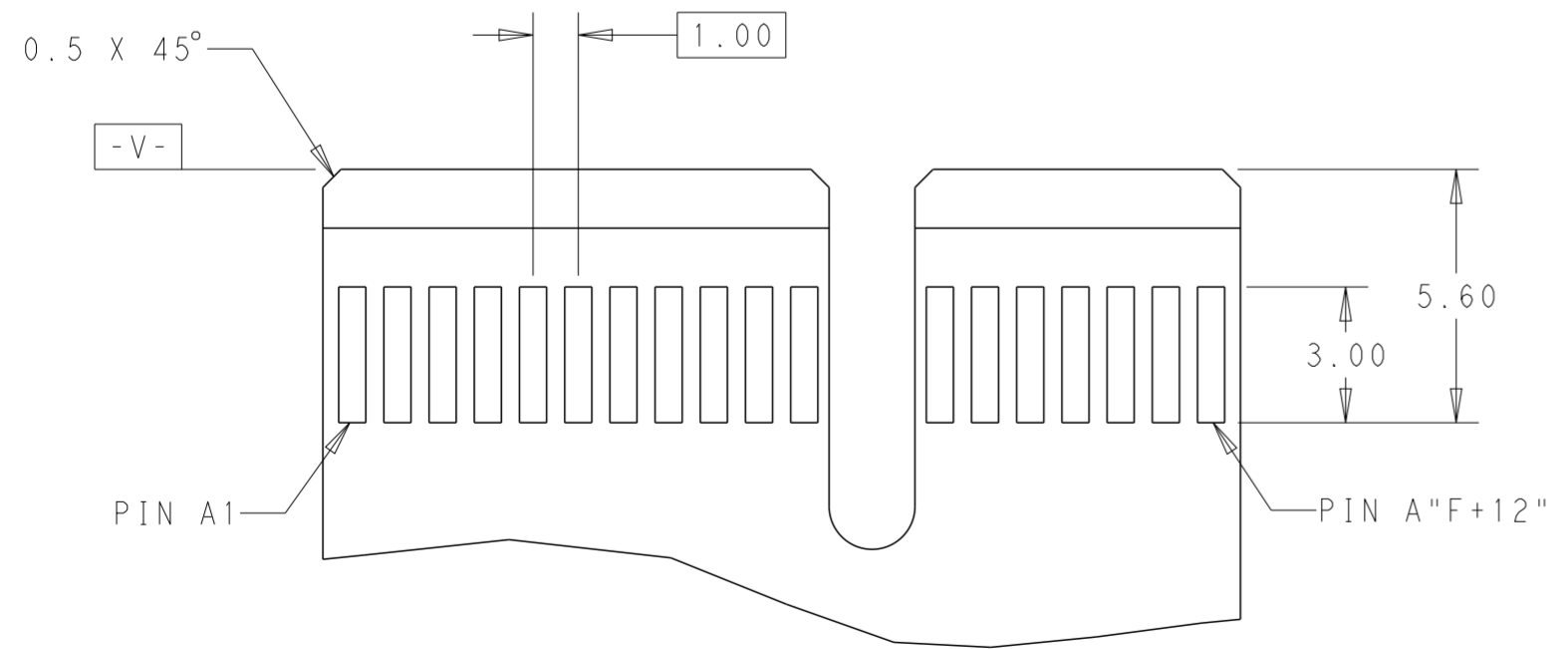

ADD-IN CARD EDGE-FINGER DIMENSION
 (36POS AS SHOWN)
 DEFAULT TOLERANCE ±0.13

164	86.82	70	73.15	72.15
98	53.82	37	40.15	39.15
64	36.82	20	23.15	22.15
36	22.82	6	9.15	8.15
POS.	DIM. E	DIM. F	DIM. G	DIM. H

THIS DRAWING IS A CONTROLLED DOCUMENT.		DWN 08APR2020 SANDERS, YAN	TE Connectivity	
DIMENSIONS: mm		CHK 08APR2020 MIKE, CHEN		
TOLERANCES UNLESS OTHERWISE SPECIFIED:		APVD 08APR2020 HOPE, LU	NAME PCI EXPRESS CARD EDGE CONNECTOR GEN5, 1.5 SOLDER TAB, WITHOUT RIDGE	
0 PLC ±	1 PLC ±0.3	PRODUCT SPEC 108-160247	SIZE CAGE CODE DRAWING NO RESTRICTED TO	
2 PLC ±0.20	3 PLC ±0.050	APPLICATION SPEC -	A200779 C-2371900	
4 PLC ±	ANGLES ±	WEIGHT -	SCALE 6:1 SHEET 3 OF 7 REV B	
MATERIAL -	FINISH -	CUSTOMER DRAWING		

THIS DRAWING IS UNPUBLISHED. RELEASED FOR PUBLICATION 20
 © COPYRIGHT 20 BY - ALL RIGHTS RESERVED.

REVISIONS					
P	LTR	DESCRIPTION	DATE	DWN	APVD
-	-	SEE SHEET 1	-	-	-

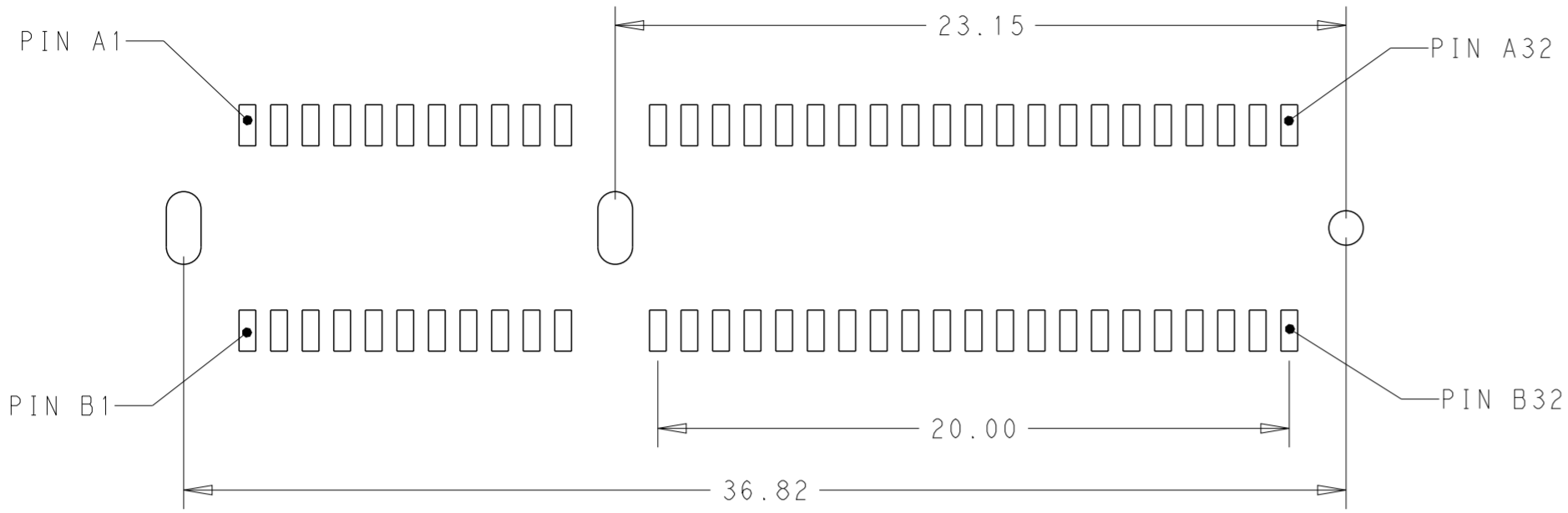

RECOMENDED PCB LAYOUT (64POS)
 OTHER DIMENSIONS SAME AS 36POS
 SCALE 5:1

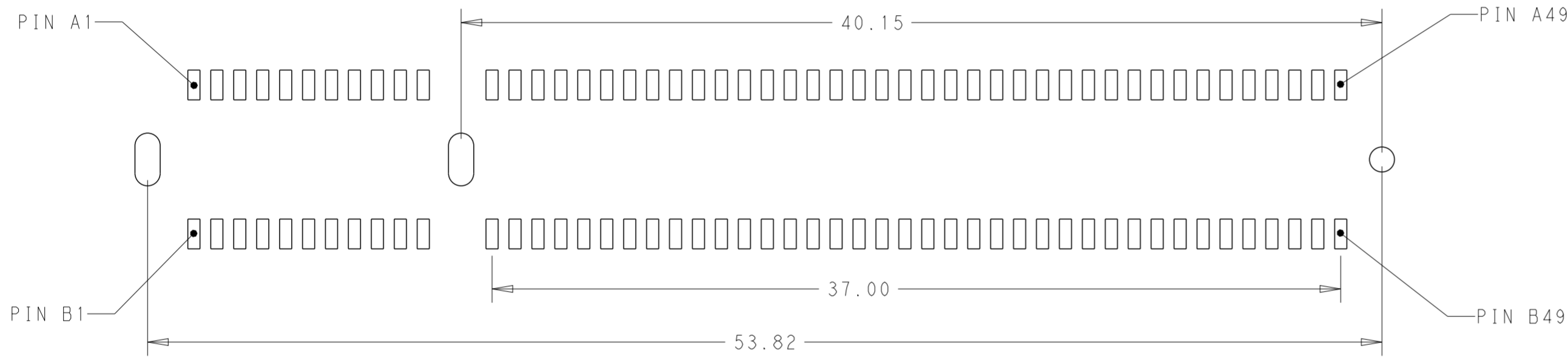

RECOMENDED PCB LAYOUT (98POS)
 OTHER DIMENSIONS SAME AS 36POS
 SCALE 5:1

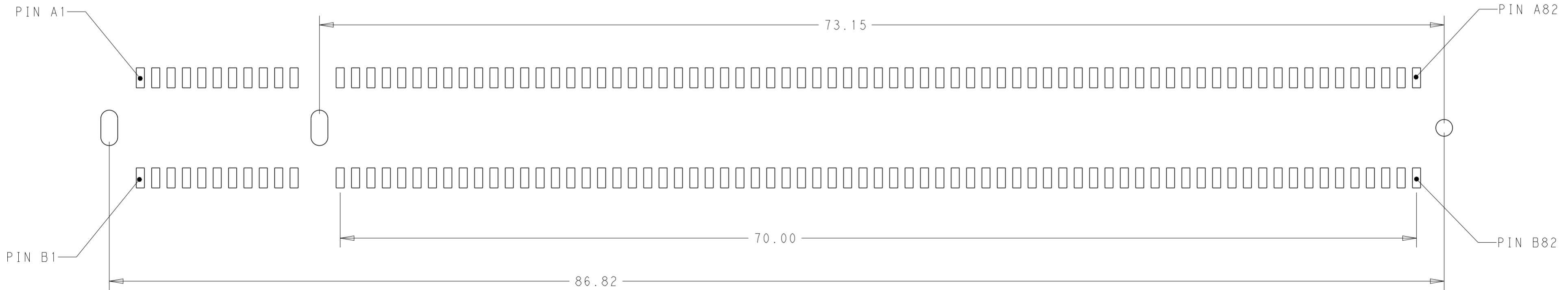

RECOMENDED PCB LAYOUT (164POS)
 OTHER DIMENSIONS SAME AS 36POS
 SCALE 5:1

THIS DRAWING IS A CONTROLLED DOCUMENT.		DWN 08APR2020 SANDERS, YAN	 TE Connectivity		
DIMENSIONS: mm		CHK 08APR2020 MIKE, CHEN			
TOLERANCES UNLESS OTHERWISE SPECIFIED: 0 PLC ±- 1 PLC ±0.3 2 PLC ±0.20 3 PLC ±0.050 4 PLC ±- ANGLES ±- FINISH -		APVD 08APR2020 HOPE, LU	NAME PCI EXPRESS CARD EDGE CONNECTOR GEN5, 1.5 SOLDER TAB, WITHOUT RIDGE		
MATERIAL -		PRODUCT SPEC 108-160247	SIZE A2	CAGE CODE 00779	DRAWING NO C-2371900
-		WEIGHT -	RESTRICTED TO -	SCALE 6:1	SHEET 4 OF 7
-		CUSTOMER DRAWING	REV B		

THIS DRAWING IS UNPUBLISHED. RELEASED FOR PUBLICATION 20
 © COPYRIGHT 20 BY - ALL RIGHTS RESERVED.

REVISIONS					
P	LTR	DESCRIPTION	DATE	DWN	APVD
-	-	SEE SHEET 1	-	-	-

FRONT VIEW

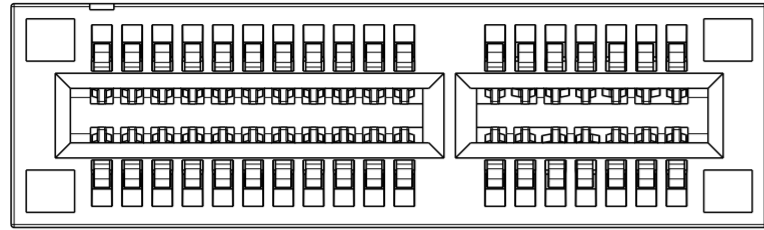

36POS AS SHOWN
SCALE 4:1

FRONT VIEW

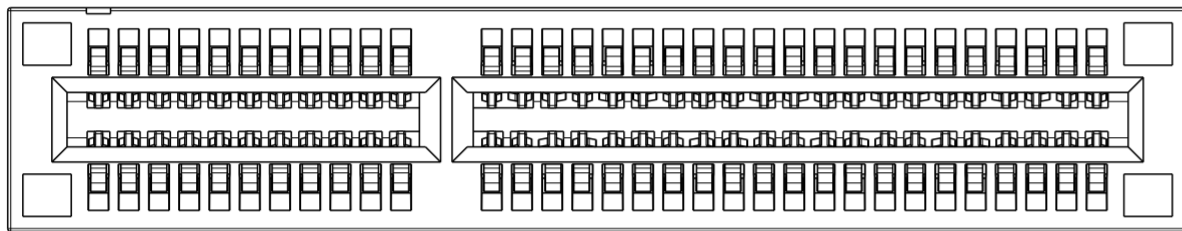

64POS AS SHOWN
SCALE 4:1

FRONT VIEW

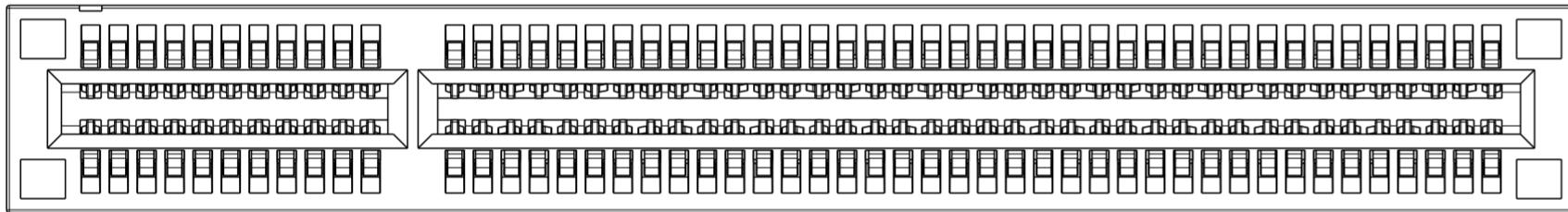

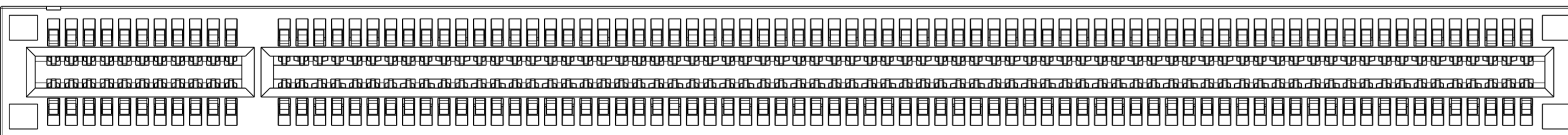

98POS AS SHOWN
SCALE 4:1

FRONT VIEW

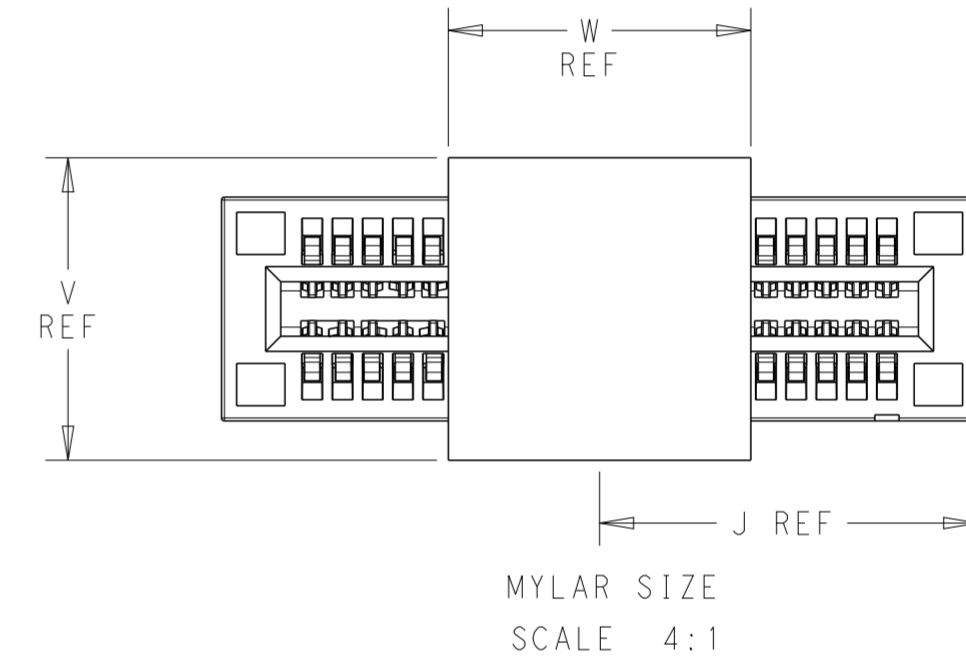

164POS AS SHOWN
SCALE 4:1

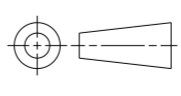

THIS DRAWING IS A CONTROLLED DOCUMENT.		DWN 08APR2020 SANDERS, YAN	 TE Connectivity	
DIMENSIONS: mm		CHK 08APR2020 MIKE, CHEN		
		APVD 08APR2020 HOPE, LU	NAME PCI EXPRESS CARD EDGE CONNECTOR GEN5, 1.5 SOLDER TAB, WITHOUT RIDGE	
TOLERANCES UNLESS OTHERWISE SPECIFIED:		PRODUCT SPEC 108-160247	SIZE A200779	CAGE CODE C-2371900
0 PLC ±-		APPLICATION SPEC -	DRAWING NO -	RESTRICTED TO -
1 PLC ±0.3		WEIGHT -	SCALE 6:1	SHEET 5 OF 7
2 PLC ±0.20		CUSTOMER DRAWING	REV B	
3 PLC ±0.050				
4 PLC ±-				
ANGLES ±-				
FINISH				

THIS DRAWING IS UNPUBLISHED. RELEASED FOR PUBLICATION 20
 © COPYRIGHT 20 BY - ALL RIGHTS RESERVED.

REVISIONS				
P	LTR	DESCRIPTION	DATE	APVD
-		SEE SHEET 1	-	-

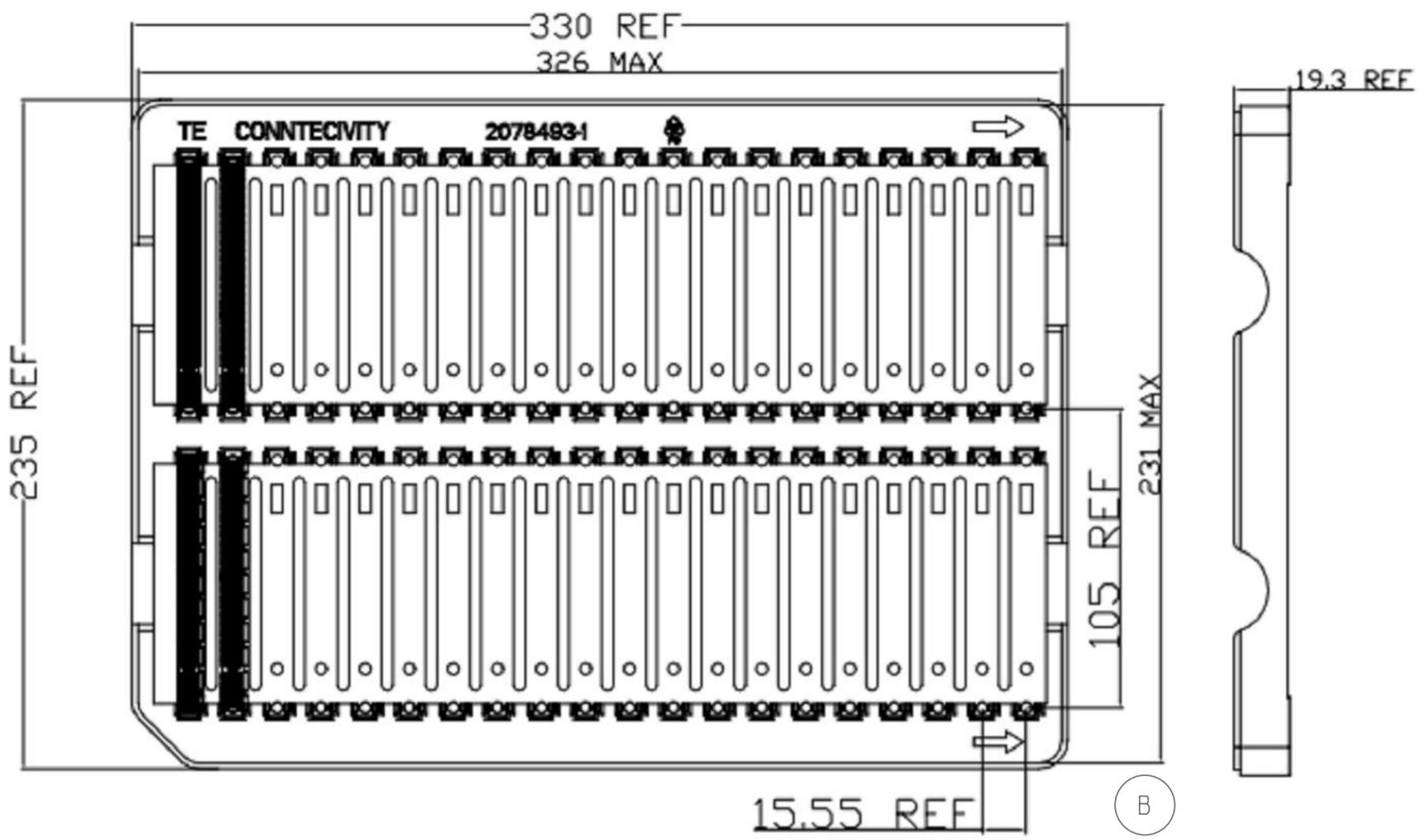

HARD TRAY: 164POS
SCALE 1:2

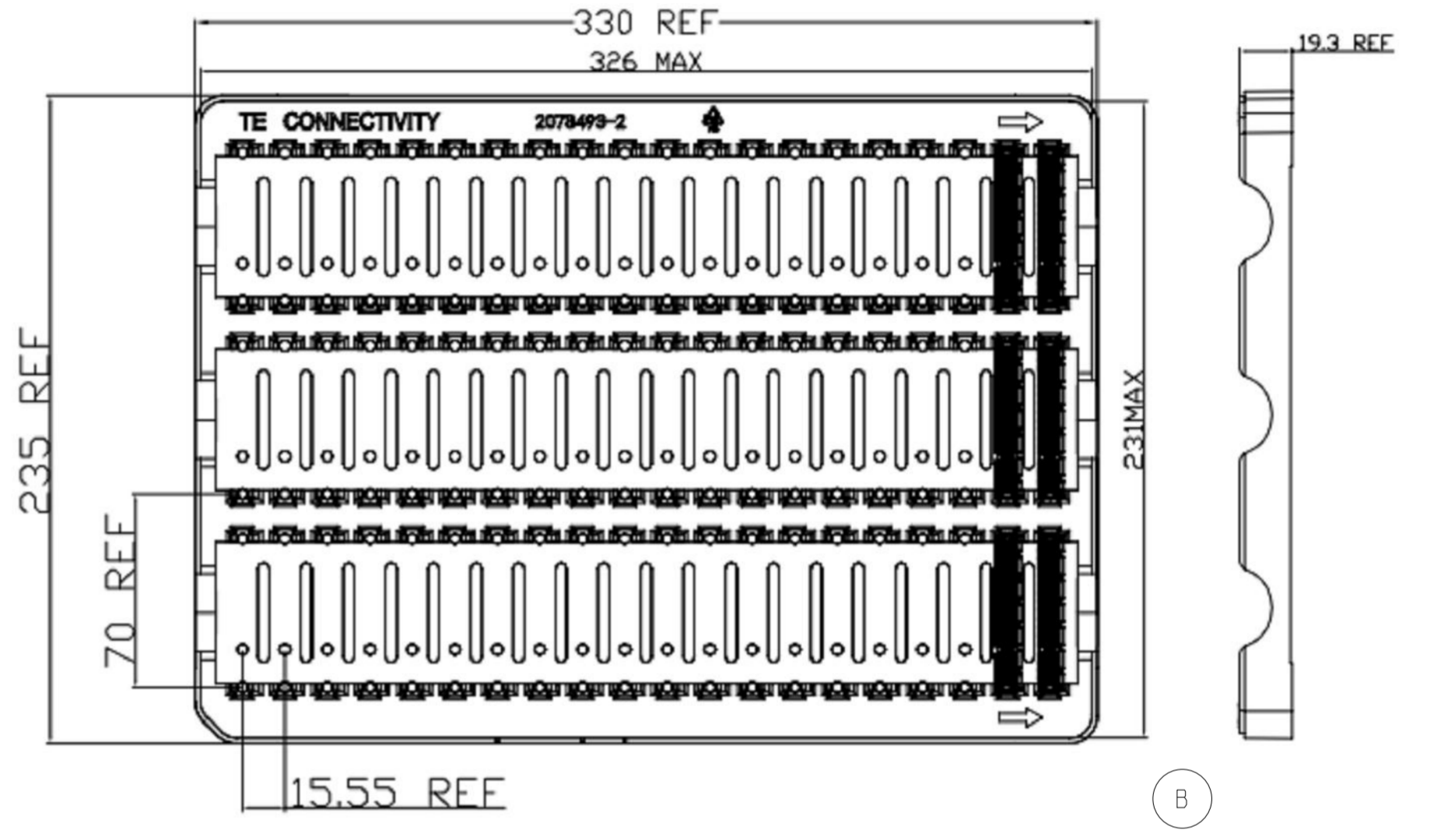

HARD TRAY: 98POS
SCALE 1:2

THIS DRAWING IS A CONTROLLED DOCUMENT.		DWN 08APR2020 SANDERS, YAN	STE TE Connectivity		
DIMENSIONS: mm		CHK 08APR2020 MIKE, CHEN			
TOLERANCES UNLESS OTHERWISE SPECIFIED:		APVD 08APR2020 HOPE, LU	NAME PCI EXPRESS CARD EDGE CONNECTOR GEN5, 1.5 SOLDER TAB, WITHOUT RIDGE		
0 PLC ± 1 PLC ±0.3 2 PLC ±0.20 3 PLC ±0.050 4 PLC ± ANGLES ± FINISH		PRODUCT SPEC 108-160247	SIZE A2	CAGE CODE 00779	DRAWING NO C-2371900
MATERIAL		APPLICATION SPEC	RESTRICTED TO		
		WEIGHT	SCALE 6:1	SHEET 6 OF 7	REV B
		CUSTOMER DRAWING			

THIS DRAWING IS UNPUBLISHED. RELEASED FOR PUBLICATION 20
 © COPYRIGHT 20 BY - ALL RIGHTS RESERVED.

REVISIONS					
P	LTR	DESCRIPTION	DATE	DWN	APVD
-	-	SEE SHEET 1	-	-	-

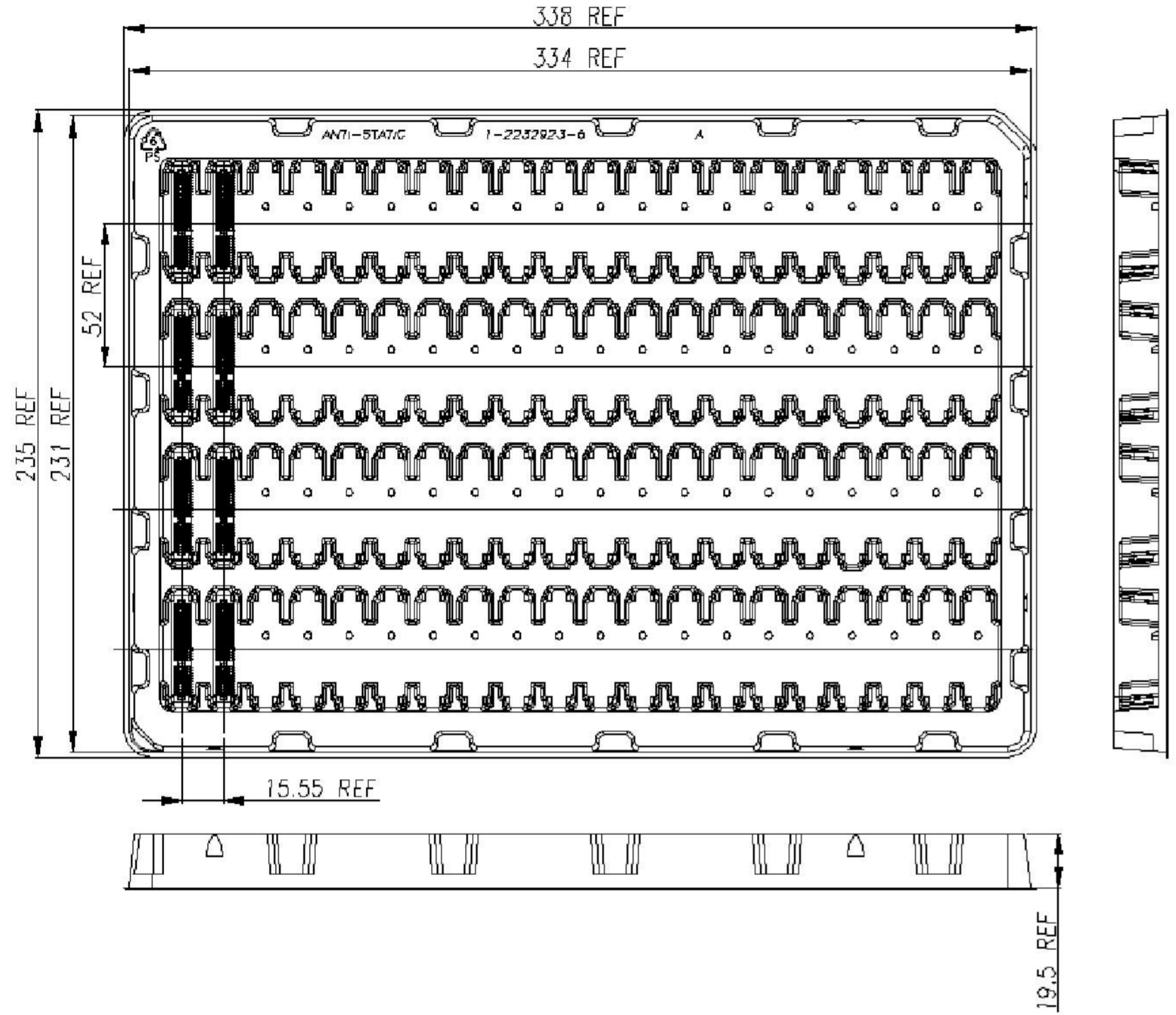

SOFT TRAY: 64POS
 SCALE 1:2

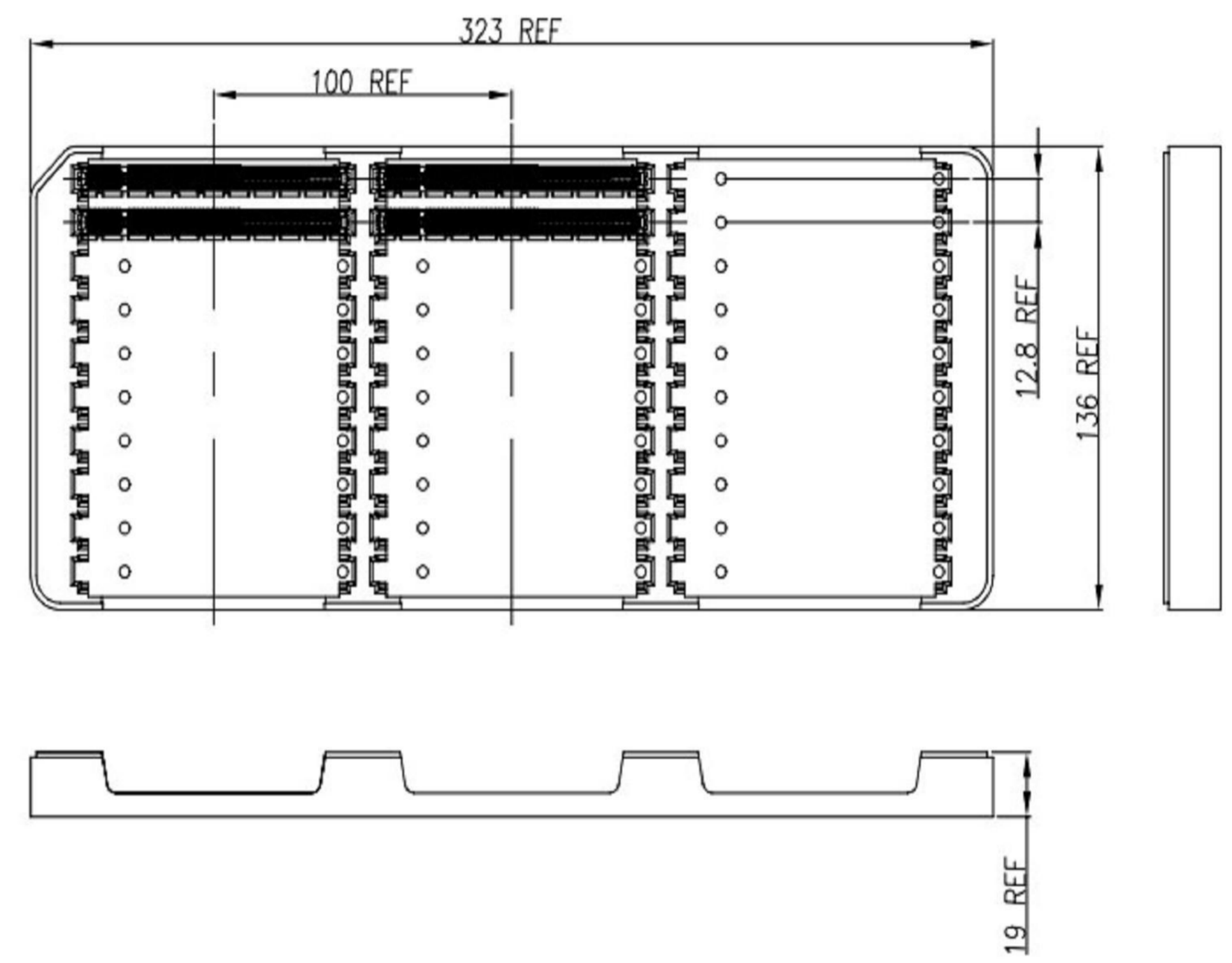

HARD TRAY: FOR 6-2371900-8 AND 8-2371900-8 (164POS)
 SCALE 1:2

THIS DRAWING IS A CONTROLLED DOCUMENT.		DWN 08APR2020 SANDERS, YAN	 TE Connectivity	
DIMENSIONS: mm		CHK 08APR2020 MIKE, CHEN		
TOLERANCES UNLESS OTHERWISE SPECIFIED:		APVD 08APR2020 HOPE, LU	NAME PCI EXPRESS CARD EDGE CONNECTOR GEN5, 1.5 SOLDER TAB, WITHOUT RIDGE	
0 PLC ±	1 PLC ±0.3	PRODUCT SPEC 108-160247	SIZE A2	CAGE CODE 00779
2 PLC ±0.20	3 PLC ±0.050	APPLICATION SPEC -	DRAWING NO C-2371900	RESTRICTED TO -
4 PLC ±	ANGLES ±	WEIGHT -	SCALE 6:1	SHEET 7 OF 7
MATERIAL -	FINISH -	CUSTOMER DRAWING	REV B	