

Crimp Adapter For 35mm wide U-Dies In Pneumatic Crimp Machine	molex	
	Application Tooling Specification Sheet	

Features

- The Quick Change Crimp Adapter allows crimp die kits to be easily installed into the bench mounted pneumatic crimp machine UP 60.
- Powered crimp capabilities help reduce fatigue and discomfort from repetitive manual crimping.

Scope

The 63801-8902 Crimp Adapter was created for use with the 35mm wide U-dies when used with the Universal Pneumatic Crimp Machine UP 60 (Order No. 63801-8900).

Installation

To install the U-dies in the Crimp Adapter and the Crimp Adapter into the Universal Pneumatic Crimp Machine UP 60, refer to the Instruction Manual TM-638018900, Section 9 *Adapters*.

Maintenance

It is recommended that each operator of the tool be made aware of, and responsible for, the following maintenance steps:

1. Remove dust, moisture and other contaminants with a clean brush, or soft, lint-free cloth.
2. Do not use any abrasive materials that could damage the tool.
3. Make certain the pins are protected with a thin coat of high quality machine oil. Do not oil excessively. This tool was engineered for durability, but like any fine piece of equipment, it needs cleaning and lubrication for a maximum service life of trouble-free crimping. The use of a light oil, such as SAE 30 weight automotive oil, every 5,000 crimps or monthly, will significantly enhance the tool life and ensure a stable calibration.
4. Store the tool in a clean and dry area when not in use.

Warranty

This tool is for electrical terminal crimping purposes only. This tool is made of the best quality materials. All vital components are long life-tested. All tools are warranted free of manufacturing defects for a period of **30 days**. Should such a defect occur, we will repair or exchange the tool free of charge. This repair or exchange will not be applicable to alter, misused, or damaged tools.

Crimp Adapter Parts List

Item Number	Order Number	Description	Quantity
1	63801-8902	Crimp Adapter for 35mm wide U-Dies with Safety Guard	1
2	63801-8992	Safety Guard	0

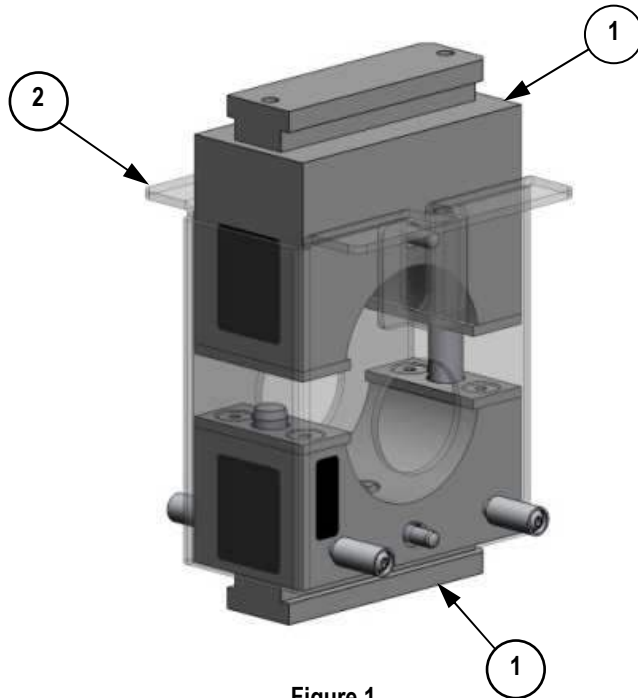

Figure 1

Contact Information

For more information on Molex application tooling please contact Molex at 1-800-786-6539.

Visit our Web site at <http://www.molex.com>