



EVQ2177-LE-00A

5.5V, 1A, 2.4MHz, Synchronous Step-Down Converter with PG and SS Evaluation Board, AEC-Q100 Qualified

DESCRIPTION

The EVQ2177-LE-00A is an evaluation board designed to demonstrate the capabilities of the MPQ2177, a monolithic, step-down switch-mode converter with integrated internal power MOSFETs.

The EVQ2177-LE-00A achieves 1A of continuous output current (I_{OUT}) across a 2.5V to 5.5V input voltage (V_{IN}) range, with excellent load and line regulation. The output voltage (V_{OUT}) can be regulated to as low as 0.6V. Fault protections include cycle-by-cycle current limiting and thermal shutdown.

The EVQ2177-LE-00A is a fully assembled and tested evaluation board. It generates a 1.2V V_{OUT} at load currents up to 1A across a 2.5V to 5.5V V_{IN} range.

The MPQ2177 is available in a compact QFN-8 (1.5mmx2mm) package.

ELECTRICAL SPECIFICATIONS

Parameter	Symbol	Value	Units
Input voltage	V_{IN}	2.5 to 5.5	V
Output voltage	V_{OUT}	1.2	V
Output current	I_{OUT}	1	A

FEATURES

- **Designed for Automotive Applications:**
 - Wide 2.5V to 5.5V Operating Input Voltage (V_{IN}) Range
 - Up to 1A Output Current
 - 1% Feedback (FB) Accuracy
- **High Performance for Improved Thermals:**
 - 75m Ω and 45m Ω Integrated Internal Power MOSFETs
- **Optimized for EMC and EMI:**
 - 2.4MHz Switching Frequency (f_{SW})
 - Forced Continuous Conduction Mode (CCM) across the Full Load Range
- **Optimized for Board Size and BOM:**
 - Integrated Compensation Network
 - Available in a Compact QFN-8 (1.5mmx2mm) Package
 - Available in AEC-Q100 Grade 1
- **Additional Features:**
 - Power Good (PG)
 - External Soft-Start (SS) Control
 - Output Discharge
 - Over-Voltage Protection (OVP) and Short-Circuit Protection (SCP) with Hiccup Mode

APPLICATIONS

- Automotive Clusters, Telematics, and Infotainment Systems
- Camera Modules
- Key Fobs
- Industrial Supplies
- Battery-Powered Devices

All MPS parts are lead-free, halogen-free, and adhere to the RoHS directive. For MPS green status, please visit the MPS website under Quality Assurance. "MPS", the MPS logo, and "Simple, Easy Solutions" are trademarks of Monolithic Power Systems, Inc. or its subsidiaries.

EVQ2177-LE-00A EVALUATION BOARD



LxWxH (6.3cmx6.3cmx0.3cm)

Board Number	MPS IC Number
EVQ2177-LE-00A	MPQ2177GQHE-AEC1

Efficiency vs. Load Current vs. Power Loss

$V_{OUT} = 1.2V$, $L = 2.2\mu H$,
(XFL4020-222MEB, DCR = 21.35m Ω)

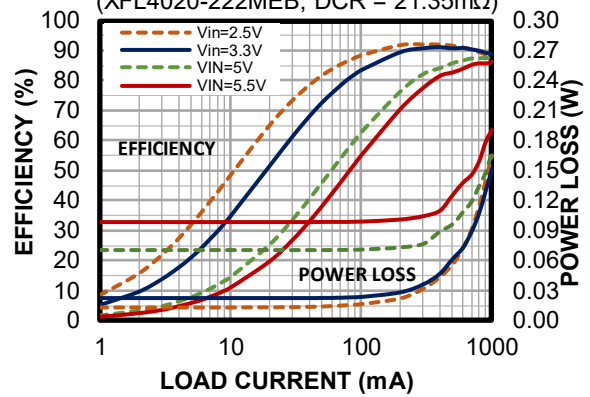

QUICK START GUIDE

1. Preset the power supply between 2.5V and 5.5V.
2. Connect the power supply terminals to:
 - a. Positive (+): VIN
 - b. Negative (-): GND
3. Connect the load terminals to:
 - a. Positive (+): VOUT
 - b. Negative (-): GND
4. After making connections, turn on the power supply.
5. To use the enable function, apply a digital input to the EN pin. Drive EN above 0.9V to turn the regulator on; drive EN below 0.65V to turn it off.
6. The external resistor divider sets the output voltage (V_{OUT}). To adjust the MPQ2177's output, set the feedback resistor (R5) to be between 10k Ω and 100k Ω . R6 can then be calculated using Equation (1):

$$R6 = \frac{R5}{\frac{V_{OUT}}{0.6} - 1} \quad (1)$$

Table 1 shows the recommended resistor values for common output voltages.

Table 1: Resistor Values for Common Output Voltages

V_{OUT} (V)	R5 (k Ω)	R6 (k Ω)
1.0	30.9 (1%)	47 (1%)
1.2	100 (1%)	100 (1%)
1.8	36 (1%)	18 (1%)
2.5	51 (1%)	16 (1%)
3.3	68 (1%)	15 (1%)

EVALUATION BOARD SCHEMATIC

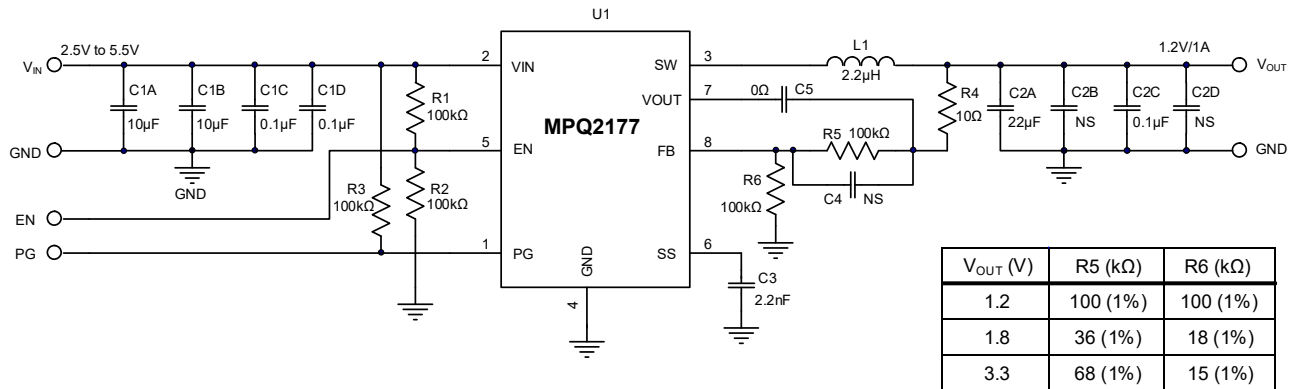

Figure 1: Evaluation Board Schematic

EVQ2177-LE-00A BILL OF MATERIALS

Qty	Ref	Value	Description	Package	Manufacturer	Manufacturer PN
1	CIN1	22 μ F	Electrolytic capacitor, 63V	SMD	Jianghai	VTD-63V22
2	C1A, C1B	4.7 μ F	Ceramic capacitor, 16V, X7R	0805	Murata	GCM21BR71C475KA73L
3	C1C, C1D, C2C	0.1 μ F	Ceramic capacitor, 16V, X7R	0603	TDK	C1608X7R1C104K
1	C2A	22 μ F	Ceramic capacitor, 6.3V, X5R	0805	Murata	GRM21BR60J226ME39L
1	C5	0 Ω	Film resistor, 1%	0603	Yageo	RC0603FR-070RL
0	C4	NS				
1	C3	2.2nF	Ceramic capacitor, 50V, X7R	0603	TDK	C1608X7R1H222K
5	R1, R2, R3, R5, R6	100k Ω	Film resistor, 1%	0603	Yageo	RC0603FR-07100KL
1	R4	10 Ω	Film resistor, 1%	0603	Yageo	RC0603FR-0710RL
1	L1	2.2 μ H	Inductor, R _{DC} = 21.35m Ω , I _{SAT} = 3.7A	SMD	Coilcraft	XFL4020-222MEB
4	VIN, GND, VOUT, GND	Test point	2.0 golden pin	DIP	Custom	
3	EN, PG, GND	Test point	1.0 golden pin	DIP	Custom	
1	U1	MPQ2177-AEC1	5.5V, 1A, step-down converter, AEC-Q100 qualified	QFN-8 (1.5mmx2mm)	MPS	MPQ2177GQHE-AEC1

EVB TEST RESULTS

Performance curves and waveforms are tested on the evaluation board. $V_{IN} = 3.6V$, $V_{OUT} = 1.2V$, $L = 2.2\mu H$, $C_{OUT} = 22\mu F$, $T_A = 25^\circ C$, unless otherwise noted.

Efficiency vs. Load Current vs. Power Loss

$V_{OUT} = 1.2V$, $L = 2.2\mu H$,
(XFL4020-222MEB, DCR = 21.35m Ω)

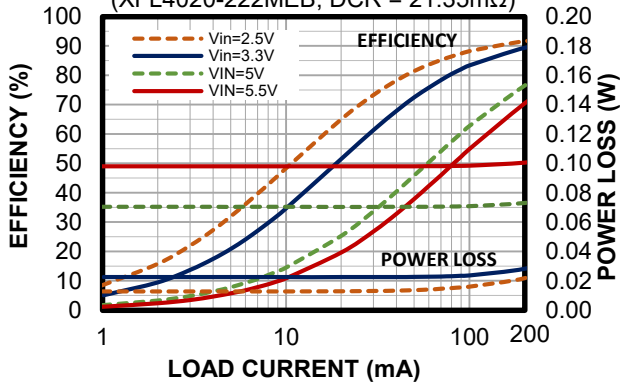

Efficiency vs. Load Current vs. Power Loss

$V_{OUT} = 1.2V$, $L = 2.2\mu H$,
(XFL4020-222MEB, DCR = 21.35m Ω)

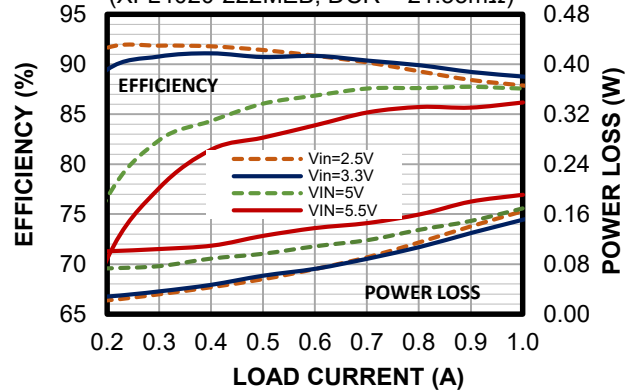

Efficiency vs. Load Current vs. Power Loss

$V_{OUT} = 1.8V$, $L = 2.2\mu H$,
(XFL4020-222MEB, DCR = 21.35m Ω)

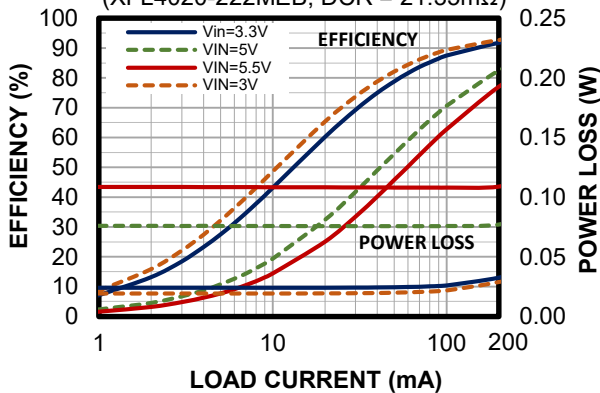

Efficiency vs. Load Current vs. Power Loss

$V_{OUT} = 1.8V$, $L = 2.2\mu H$,
(XFL4020-222MEB, DCR = 21.35m Ω)

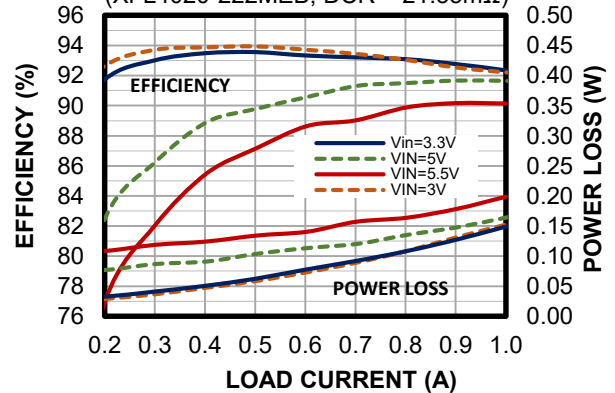

Load Regulation

$V_{OUT} = 1.8V$

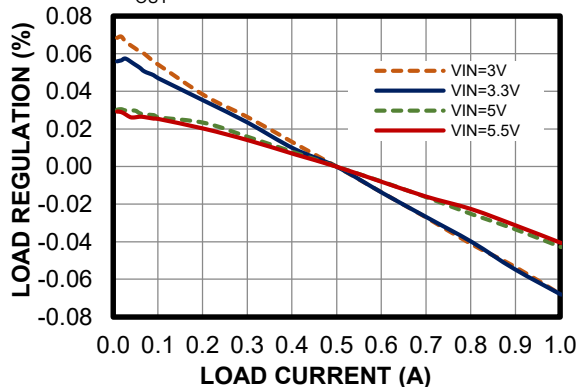

Load Regulation

$V_{OUT} = 1.2V$

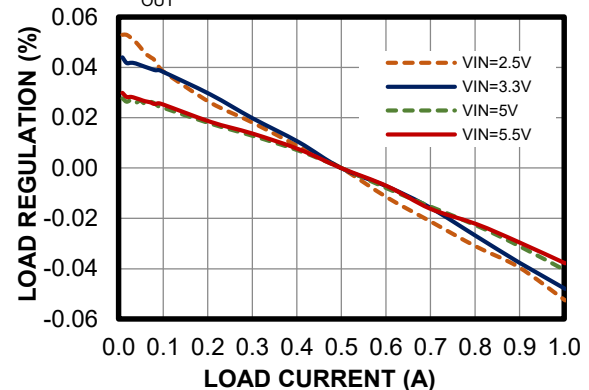

EVB TEST RESULTS *(continued)*

Performance curves and waveforms are tested on the evaluation board. $V_{IN} = 3.6V$, $V_{OUT} = 1.2V$, $L = 2.2\mu H$, $C_{OUT} = 22\mu F$, $T_A = 25^\circ C$, unless otherwise noted.

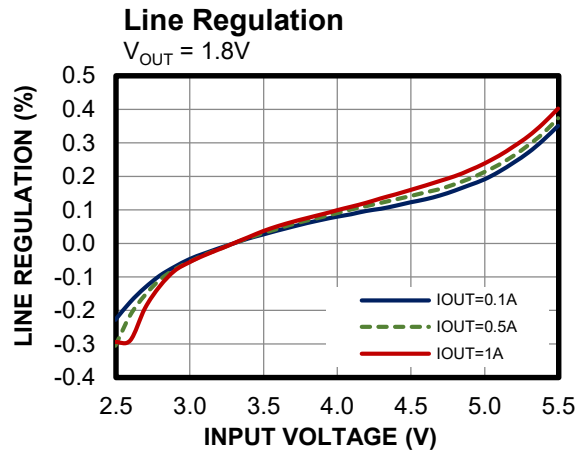
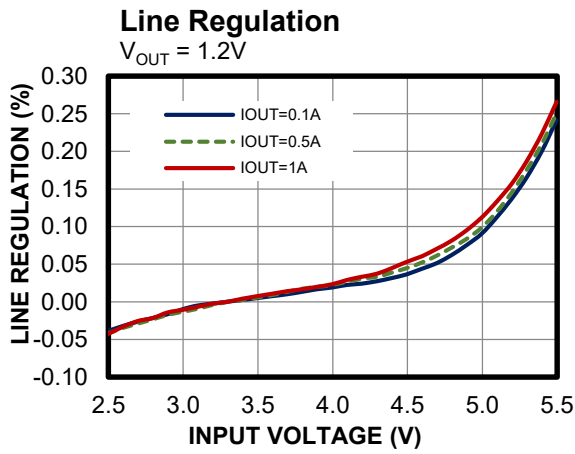

EVB TEST RESULTS (continued)

Performance curves and waveforms are tested on the evaluation board. $V_{IN} = 3.6V$, $V_{OUT} = 1.2V$, $L = 2.2\mu H$, $C_{OUT} = 22\mu F$, $T_A = 25^\circ C$, unless otherwise noted.

Steady State

$I_{OUT} = 0A$

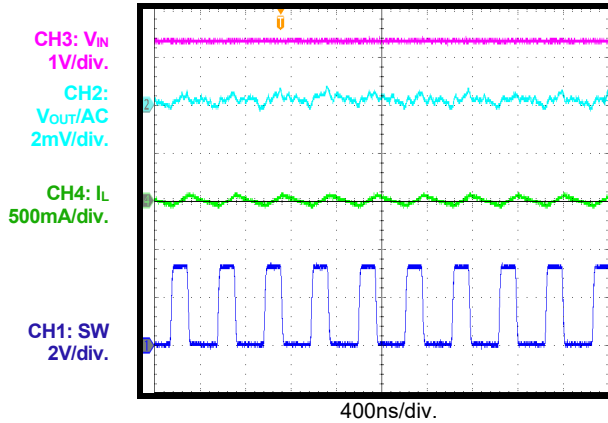

Steady State

$I_{OUT} = 1A$

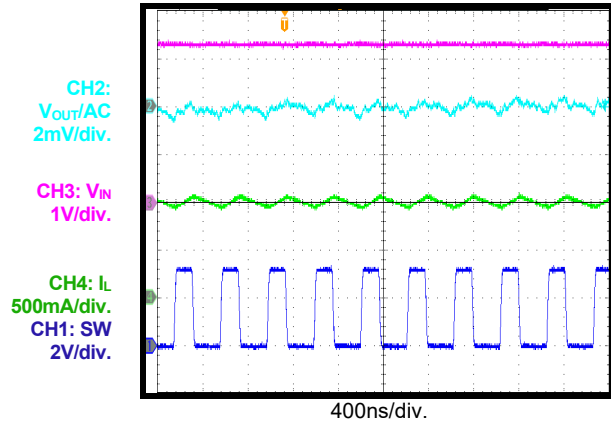

Start-Up through VIN

$I_{OUT} = 0A$

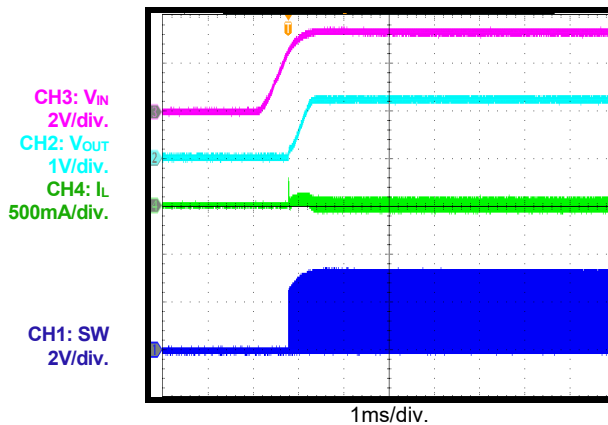

Start-Up through VIN

$I_{OUT} = 1A$

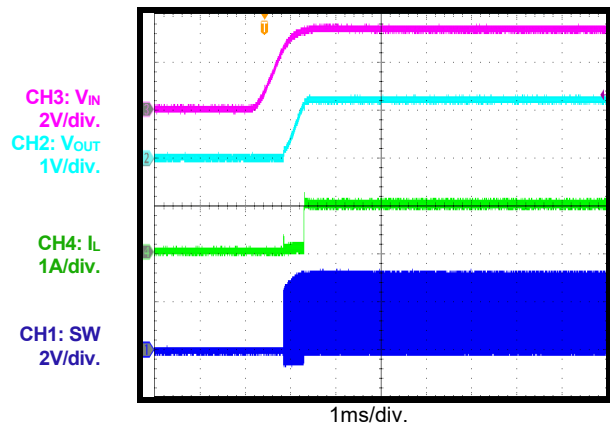

Shutdown through VIN

$I_{OUT} = 0A$

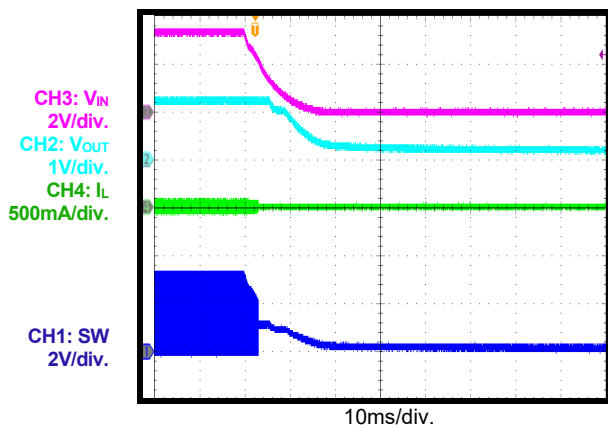

Shutdown through VIN

$I_{OUT} = 1A$

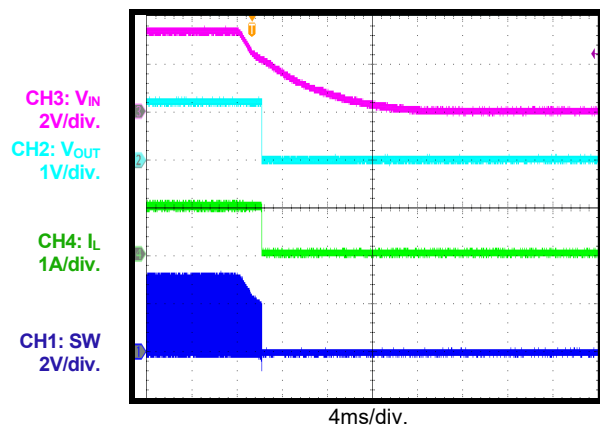

EVB TEST RESULTS *(continued)*

Performance curves and waveforms are tested on the evaluation board. $V_{IN} = 3.6V$, $V_{OUT} = 1.2V$, $L = 2.2\mu H$, $C_{OUT} = 22\mu F$, $T_A = 25^\circ C$, unless otherwise noted.

Start-Up through EN

$I_{OUT} = 0A$

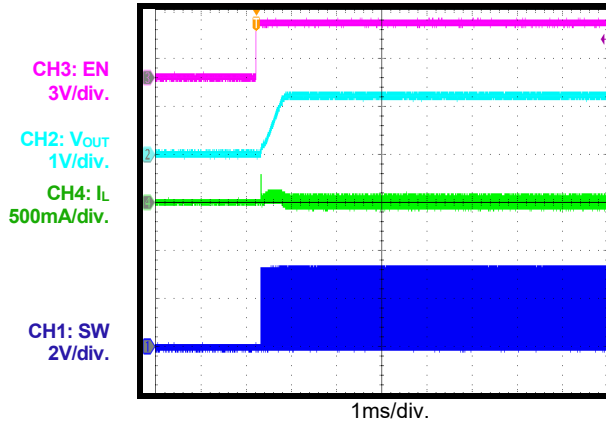

Start-Up through EN

$I_{OUT} = 1A$

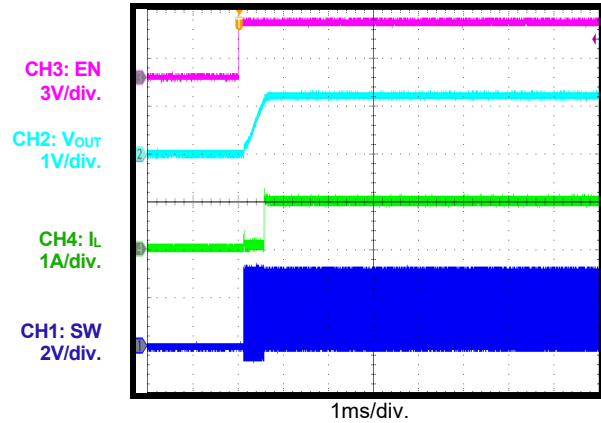

Shutdown through EN

$I_{OUT} = 0A$

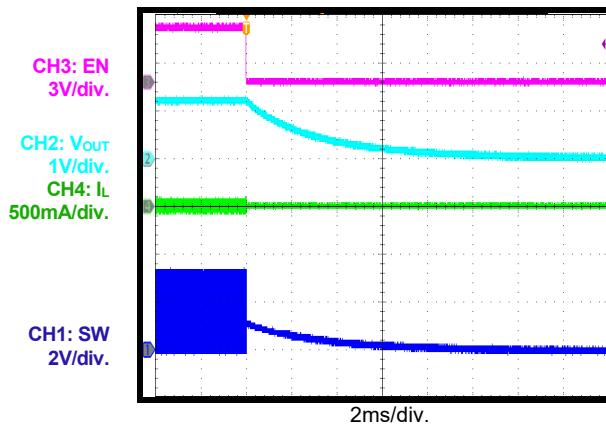

Shutdown through EN

$I_{OUT} = 1A$

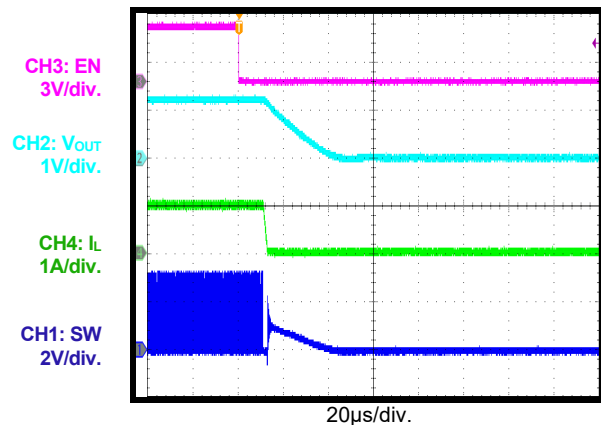

SCP Entry

$I_{OUT} = 0A$

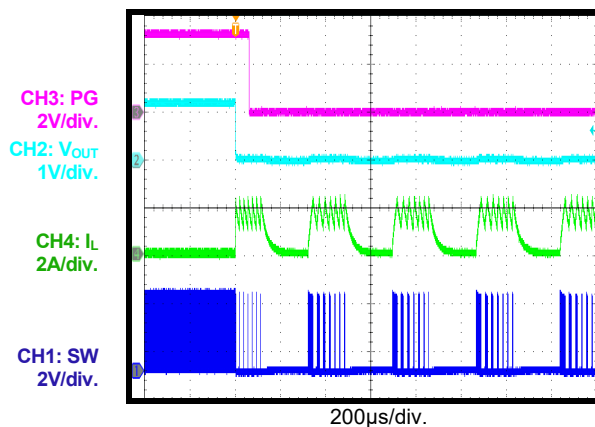

SCP Entry

$I_{OUT} = 1A$

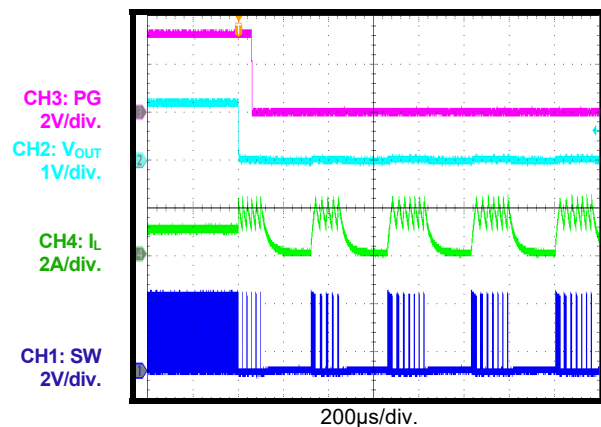

EVB TEST RESULTS (continued)

Performance curves and waveforms are tested on the evaluation board. $V_{IN} = 3.6V$, $V_{OUT} = 1.2V$, $L = 2.2\mu H$, $C_{OUT} = 22\mu F$, $T_A = 25^\circ C$, unless otherwise noted.

SCP Recovery

$I_{OUT} = 0A$

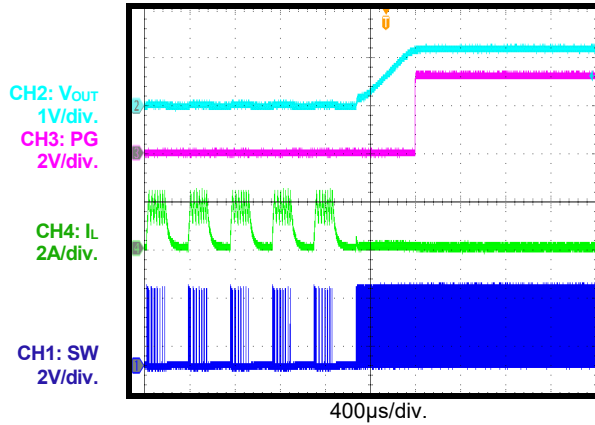

SCP Recovery

$I_{OUT} = 1A$

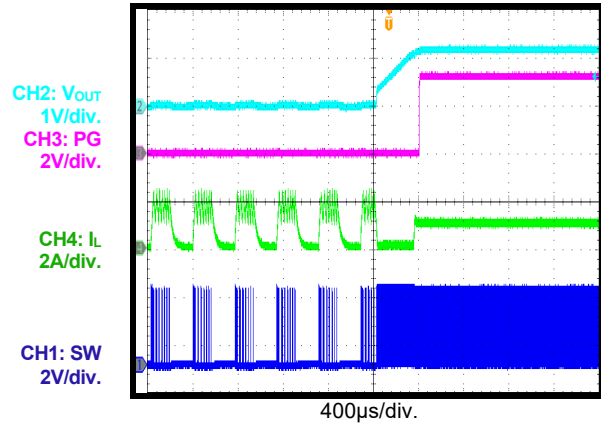

Short Circuit

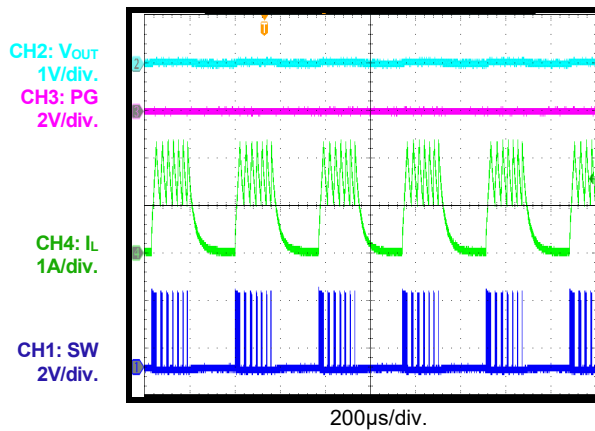

PG in Start-Up through VIN

$I_{OUT} = 1A$

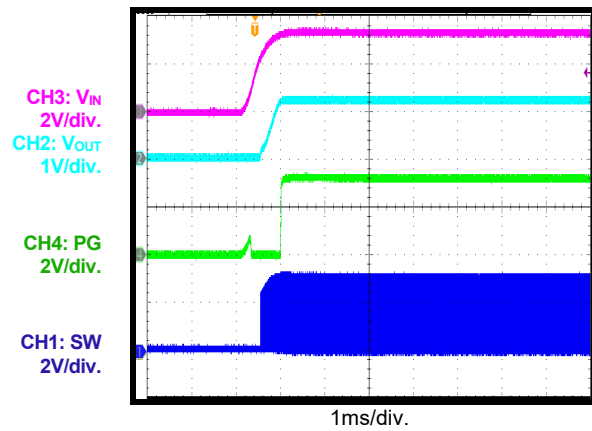

PG in Shutdown through VIN

$I_{OUT} = 1A$

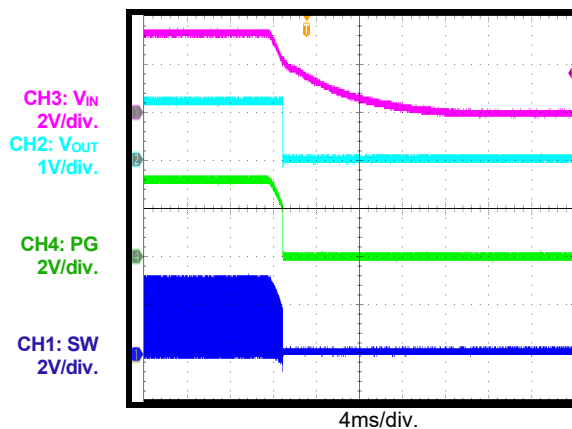

PG in Start-Up through EN

$I_{OUT} = 1A$

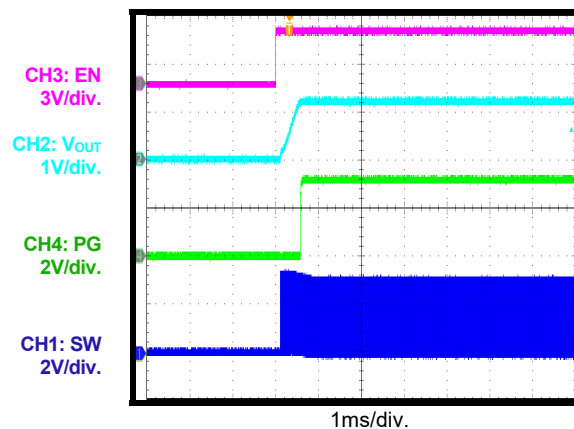

EVB TEST RESULTS *(continued)*

Performance curves and waveforms are tested on the evaluation board. $V_{IN} = 3.6V$, $V_{OUT} = 1.2V$, $L = 2.2\mu H$, $C_{OUT} = 22\mu F$, $T_A = 25^\circ C$, unless otherwise noted.

PG in Shutdown through EN
 $I_{OUT} = 1A$

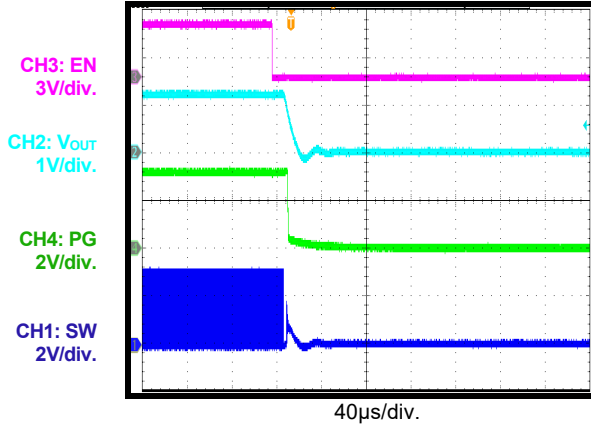

Load Transient
 $I_{OUT} = 0.5A \text{ to } 1A, 1A/\mu s$

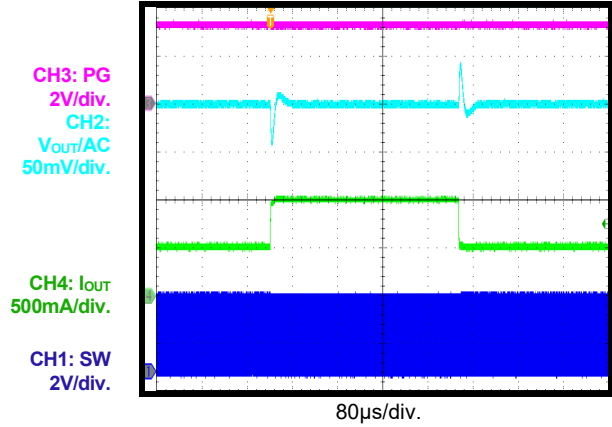

PCB LAYOUT

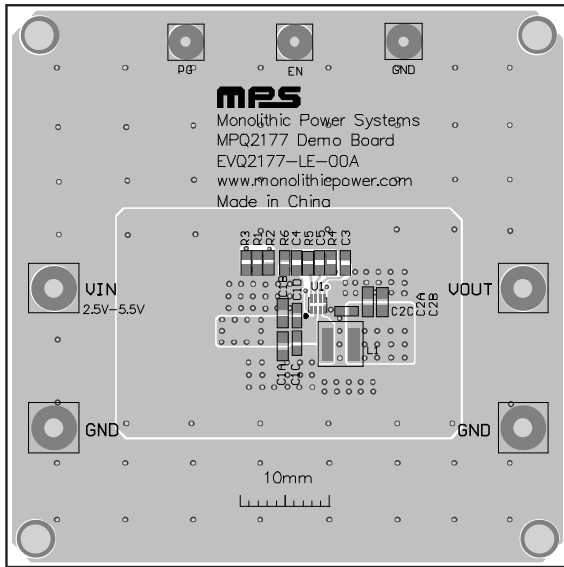

Figure 2: Top Silk and Top Layer

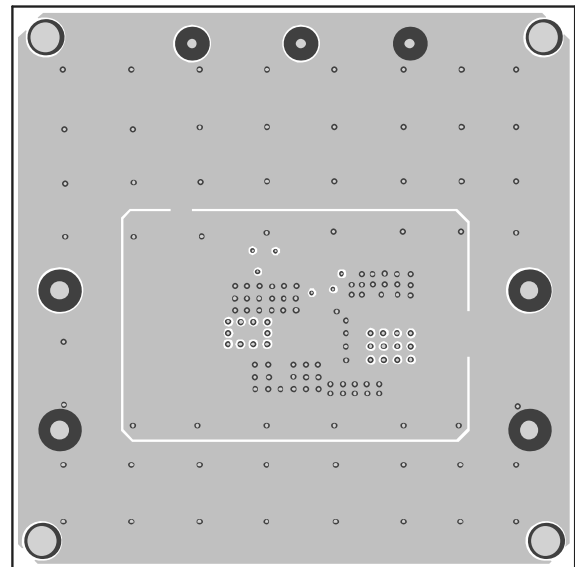

Figure 3: Mid-Layer 1

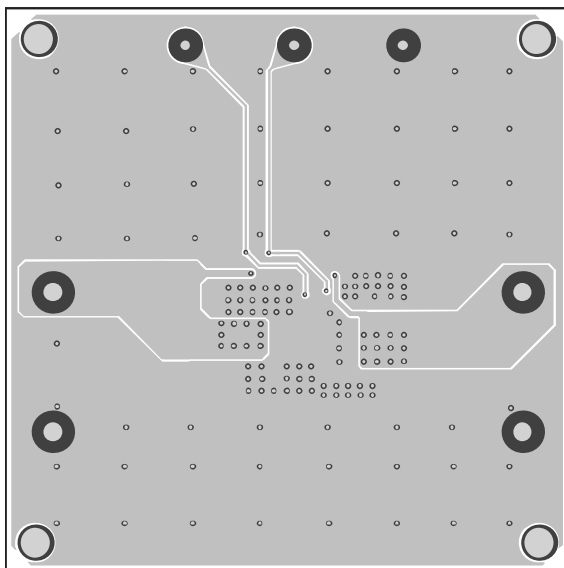

Figure 4: Mid-Layer 2

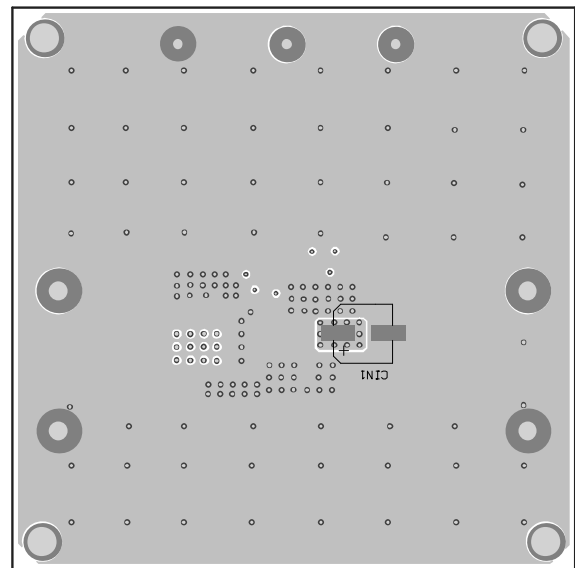

Figure 5: Bottom Layer and Bottom Silk



REVISION HISTORY

Revision #	Revision Date	Description	Pages Updated
1.0	09/29/2021	Initial Release	-

Notice: The information in this document is subject to change without notice. Please contact MPS for current specifications. Users should warrant and guarantee that third-party Intellectual Property rights are not infringed upon when integrating MPS products into any application. MPS will not assume any legal responsibility for any said applications.