

ON Semiconductor

Is Now

onsemi™

To learn more about onsemi™, please visit our website at
www.onsemi.com

onsemi and **onsemi** and other names, marks, and brands are registered and/or common law trademarks of Semiconductor Components Industries, LLC dba "**onsemi**" or its affiliates and/or subsidiaries in the United States and/or other countries. **onsemi** owns the rights to a number of patents, trademarks, copyrights, trade secrets, and other intellectual property. A listing of **onsemi** product/patent coverage may be accessed at www.onsemi.com/site/pdf/Patent-Marking.pdf. **onsemi** reserves the right to make changes at any time to any products or information herein, without notice. The information herein is provided "as-is" and **onsemi** makes no warranty, representation or guarantee regarding the accuracy of the information, product features, availability, functionality, or suitability of its products for any particular purpose, nor does **onsemi** assume any liability arising out of the application or use of any product or circuit, and specifically disclaims any and all liability, including without limitation special, consequential or incidental damages. Buyer is responsible for its products and applications using **onsemi** products, including compliance with all laws, regulations and safety requirements or standards, regardless of any support or applications information provided by **onsemi**. "Typical" parameters which may be provided in **onsemi** data sheets and/or specifications can and do vary in different applications and actual performance may vary over time. All operating parameters, including "Typicals" must be validated for each customer application by customer's technical experts. **onsemi** does not convey any license under any of its intellectual property rights nor the rights of others. **onsemi** products are not designed, intended, or authorized for use as a critical component in life support systems or any FDA Class 3 medical devices or medical devices with a same or similar classification in a foreign jurisdiction or any devices intended for implantation in the human body. Should Buyer purchase or use **onsemi** products for any such unintended or unauthorized application, Buyer shall indemnify and hold **onsemi** and its officers, employees, subsidiaries, affiliates, and distributors harmless against all claims, costs, damages, and expenses, and reasonable attorney fees arising out of, directly or indirectly, any claim of personal injury or death associated with such unintended or unauthorized use, even if such claim alleges that **onsemi** was negligent regarding the design or manufacture of the part. **onsemi** is an Equal Opportunity/Affirmative Action Employer. This literature is subject to all applicable copyright laws and is not for resale in any manner. Other names and brands may be claimed as the property of others.

NTP45N06L, NTB45N06L

Power MOSFET 45 Amps, 60 Volts

Logic Level, N-Channel TO-220 and D²PAK

Designed for low voltage, high speed switching applications in power supplies, converters and power motor controls and bridge circuits.

Features

- Higher Current Rating
- Lower $R_{DS(on)}$
- Lower $V_{DS(on)}$
- Lower Capacitances
- Lower Total Gate Charge
- Tighter V_{SD} Specification
- Lower Diode Reverse Recovery Time
- Lower Reverse Recovery Stored Charge
- Pb-Free Packages are Available

Typical Applications

- Power Supplies
- Converters
- Power Motor Controls
- Bridge Circuits



ON Semiconductor[®]

<http://onsemi.com>

45 AMPERES, 60 VOLTS

$R_{DS(on)} = 28 \text{ m}\Omega$

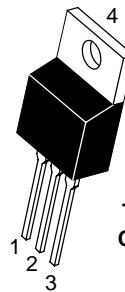
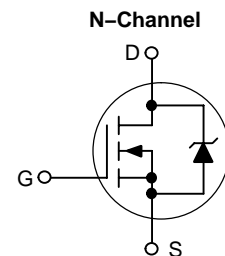

**TO-220AB
CASE 221A
STYLE 5**

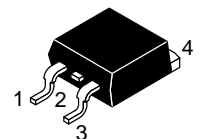

**D²PAK
CASE 418B
STYLE 2**

MARKING DIAGRAMS & PIN ASSIGNMENTS

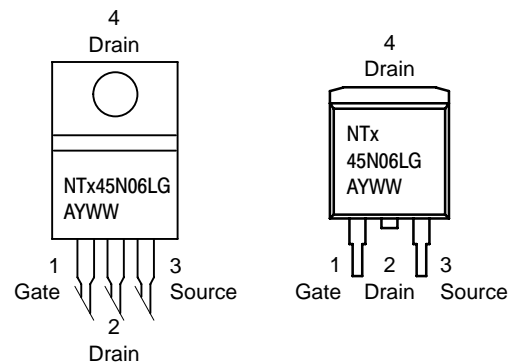

NTx45N06L = Device Code
x = B or P
A = Assembly Location
Y = Year
WW = Work Week
G = Pb-Free Package

ORDERING INFORMATION

See detailed ordering and shipping information in the package dimensions section on page 2 of this data sheet.

NTP45N06L, NTB45N06L

MAXIMUM RATINGS (T_J = 25°C unless otherwise noted)

Rating	Symbol	Value	Unit
Drain-to-Source Voltage	V _{DSS}	60	Vdc
Drain-to-Gate Voltage (R _{GS} = 10 MΩ)	V _{DGR}	60	Vdc
Gate-to-Source Voltage – Continuous – Non-Repetitive (t _p ≤ 10 ms)	V _{GS} V _{GS}	± 15 ± 20	Vdc
Drain Current – Continuous @ T _A = 25°C – Continuous @ T _A = 100°C – Single Pulse (t _p ≤ 10 μs)	I _D I _D I _{DM}	45 30 150	Adc Adc Apk
Total Power Dissipation @ T _A = 25°C Derate above 25°C Total Power Dissipation @ T _A = 25°C (Note 1) Total Power Dissipation @ T _A = 25°C (Note 2)	P _D	125 0.83 3.2 2.4	W W/°C W W
Operating and Storage Temperature Range	T _J , T _{stg}	–55 to +175	°C
Single Pulse Drain-to-Source Avalanche Energy – Starting T _J = 25°C (V _{DD} = 50 Vdc, V _{GS} = 5.0 Vdc, L = 0.3 mH I _{L(pk)} = 40 A, V _{DS} = 60 Vdc, R _G = 25 Ω)	E _{AS}	240	mJ
Thermal Resistance – Junction-to-Case – Junction-to-Ambient (Note 1) – Junction-to-Ambient (Note 2)	R _{θJC} R _{θJA} R _{θJA}	1.2 46.8 63.2	°C/W
Maximum Lead Temperature for Soldering Purposes, 1/8 in from case for 10 seconds	T _L	260	°C

Maximum ratings are those values beyond which device damage can occur. Maximum ratings applied to the device are individual stress limit values (not normal operating conditions) and are not valid simultaneously. If these limits are exceeded, device functional operation is not implied, damage may occur and reliability may be affected.

- When surface mounted to an FR4 board using 1" pad size, (Cu Area 1.127 in²).
- When surface mounted to an FR4 board using the minimum recommended pad size, (Cu Area 0.412 in²).

ORDERING INFORMATION

Device	Package	Shipping†
NTP45N06L	TO–220	50 Units / Rail
NTP45N06LG	TO–220 (Pb-Free)	50 Units / Rail
NTB45N06L	D ² PAK	50 Units / Rail
NTB45N06LG	D ² PAK (Pb-Free)	50 Units / Rail
NTB45N06LT4	D ² PAK	800 Tape & Reel
NTB45N06LT4G	D ² PAK (Pb-Free)	800 Tape & Reel

†For information on tape and reel specifications, including part orientation and tape sizes, please refer to our Tape and Reel Packaging Specifications Brochure, BRD8011/D.

NTP45N06L, NTB45N06L

ELECTRICAL CHARACTERISTICS (T_J = 25°C unless otherwise noted)

Characteristic	Symbol	Min	Typ	Max	Unit
----------------	--------	-----	-----	-----	------

OFF CHARACTERISTICS

Drain-to-Source Breakdown Voltage (Note 3) (V _{GS} = 0 Vdc, I _D = 250 μAdc) Temperature Coefficient (Positive)	V _{(BR)DSS}	60 –	67 67.2	– –	Vdc mV/°C
Zero Gate Voltage Drain Current (V _{DS} = 60 Vdc, V _{GS} = 0 Vdc) (V _{DS} = 60 Vdc, V _{GS} = 0 Vdc, T _J = 150°C)	I _{DSS}	– –	– –	1.0 10	μAdc
Gate-Body Leakage Current (V _{GS} = ±15 Vdc, V _{DS} = 0 Vdc)	I _{GSS}	–	–	±100	nAdc

ON CHARACTERISTICS (Note 4)

Gate Threshold Voltage (Note 4) (V _{DS} = V _{GS} , I _D = 250 μAdc) Threshold Temperature Coefficient (Negative)	V _{GS(th)}	1.0 –	1.8 4.7	2.0 –	Vdc mV/°C
Static Drain-to-Source On-Resistance (Note 4) (V _{GS} = 5.0 Vdc, I _D = 22.5 Adc)	R _{DS(on)}	–	23	28	mΩ
Static Drain-to-Source On-Voltage (Note 4) (V _{GS} = 5.0 Vdc, I _D = 45 Adc) (V _{GS} = 5.0 Vdc, I _D = 22.5 Adc, T _J = 150°C)	V _{DS(on)}	– –	1.03 0.93	1.51 –	Vdc
Forward Transconductance (Note 4) (V _{DS} = 8.0 Vdc, I _D = 12 Adc)	g _{FS}	–	22.8	–	mhos

DYNAMIC CHARACTERISTICS

Input Capacitance	(V _{DS} = 25 Vdc, V _{GS} = 0 Vdc, f = 1.0 MHz)	C _{iss}	–	1212	1700	pF
Output Capacitance		C _{oss}	–	352	480	
Transfer Capacitance		C _{rss}	–	90	180	

SWITCHING CHARACTERISTICS (Note 5)

Turn-On Delay Time	(V _{DD} = 30 Vdc, I _D = 45 Adc, V _{GS} = 5.0 Vdc, R _G = 9.1 Ω) (Note 4)	t _{d(on)}	–	13	30	ns
Rise Time		t _r	–	341	680	
Turn-Off Delay Time		t _{d(off)}	–	36	75	
Fall Time		t _f	–	158	320	
Gate Charge	(V _{DS} = 48 Vdc, I _D = 45 Adc, V _{GS} = 5.0 Vdc) (Note 4)	Q _T	–	23	32	nC
		Q ₁	–	4.6	–	
		Q ₂	–	14.1	–	

SOURCE-DRAIN DIODE CHARACTERISTICS

Forward On-Voltage	(I _S = 45 Adc, V _{GS} = 0 Vdc) (Note 4) (I _S = 45 Adc, V _{GS} = 0 Vdc, T _J = 150°C)	V _{SD}	– –	1.01 0.92	1.15 –	Vdc
Reverse Recovery Time	(I _S = 45 Adc, V _{GS} = 0 Vdc, di _S /dt = 100 A/μs) (Note 4)	t _{rr}	–	56	–	ns
		t _a	–	30	–	
		t _b	–	26	–	
Reverse Recovery Stored Charge		Q _{RR}	–	0.09	–	μC

3. When surface mounted to an FR4 board using the minimum recommended pad size, (Cu Area 0.412 in²).

4. Pulse Test: Pulse Width ≤ 300 μs, Duty Cycle ≤ 2%.

5. Switching characteristics are independent of operating junction temperatures.

NTP45N06L, NTB45N06L

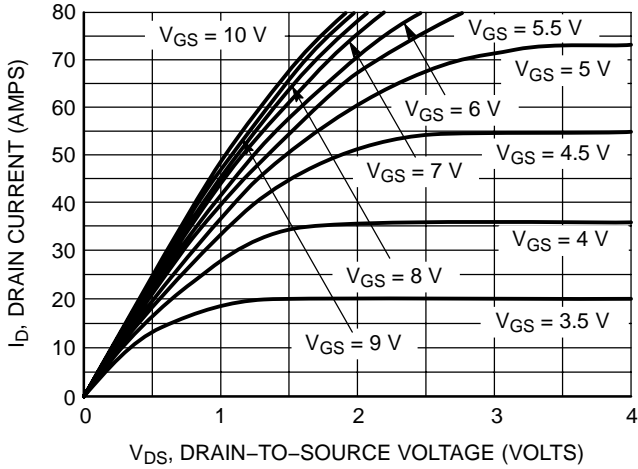

Figure 1. On-Region Characteristics

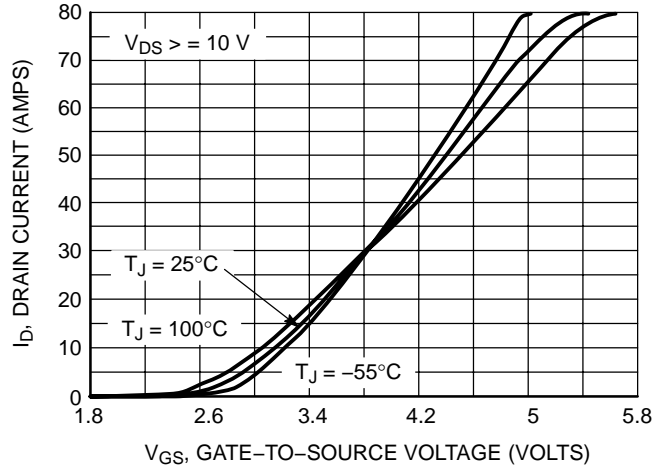

Figure 2. Transfer Characteristics

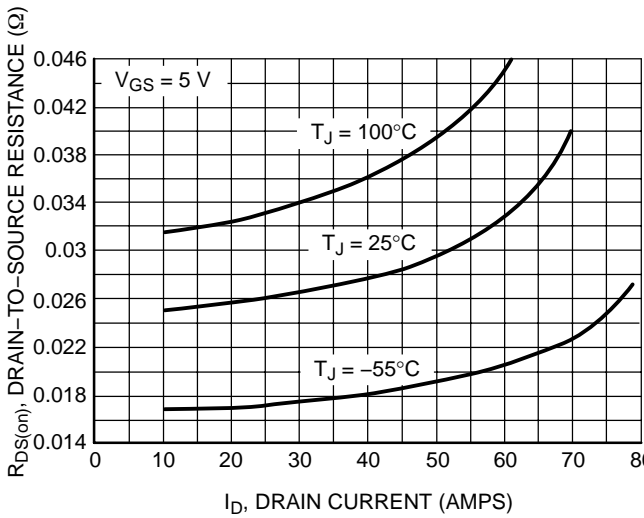

Figure 3. On-Resistance vs. Gate-to-Source Voltage

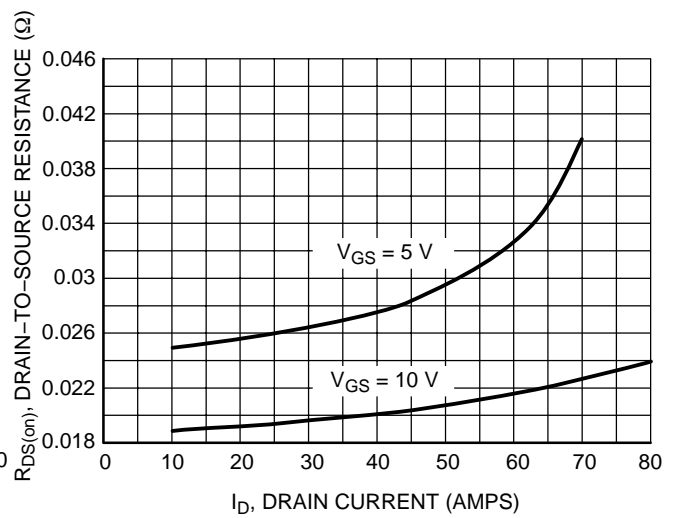

Figure 4. On-Resistance vs. Drain Current and Gate Voltage

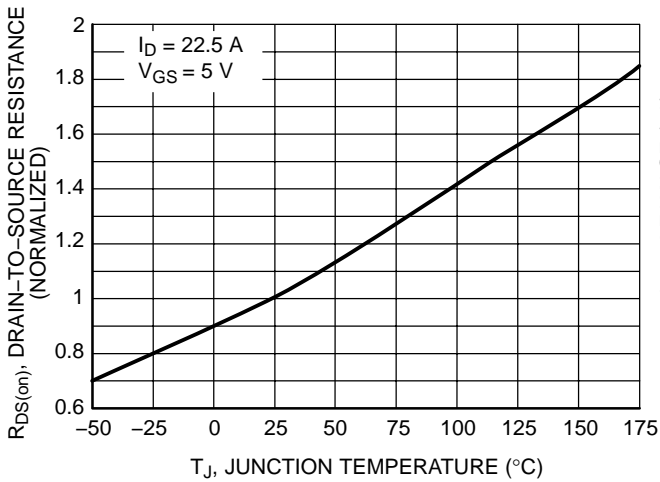

Figure 5. On-Resistance Variation with Temperature

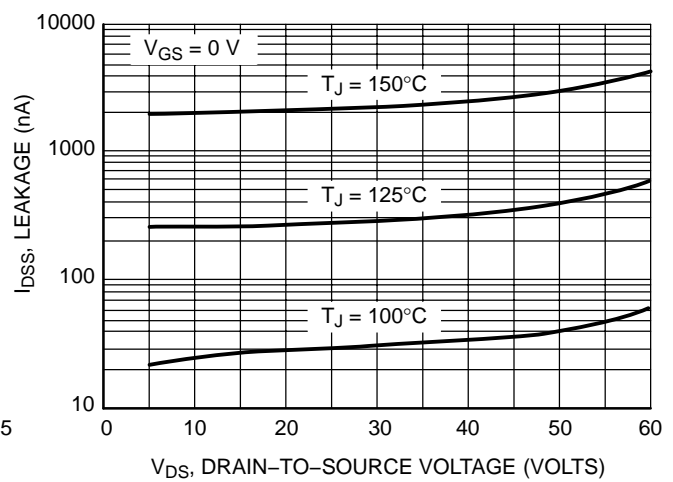

Figure 6. Drain-to-Source Leakage Current vs. Voltage

NTP45N06L, NTB45N06L

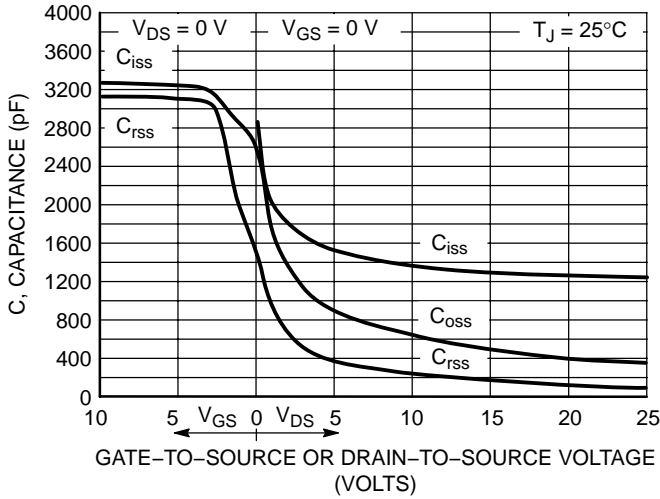

Figure 7. Capacitance Variation

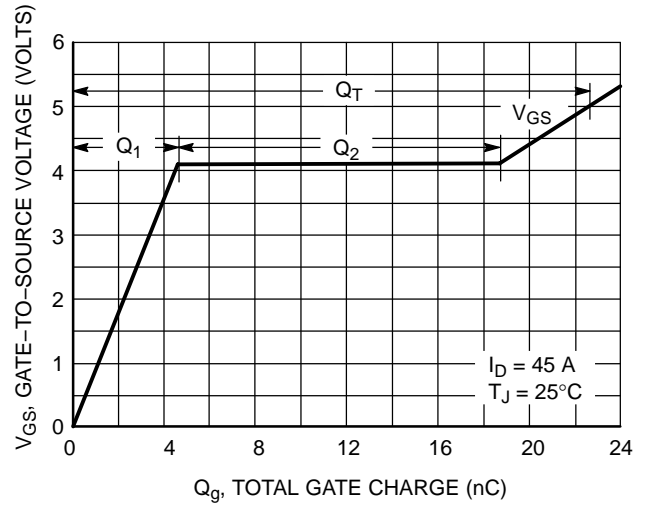

Figure 8. Gate-to-Source and Drain-to-Source Voltage vs. Total Charge

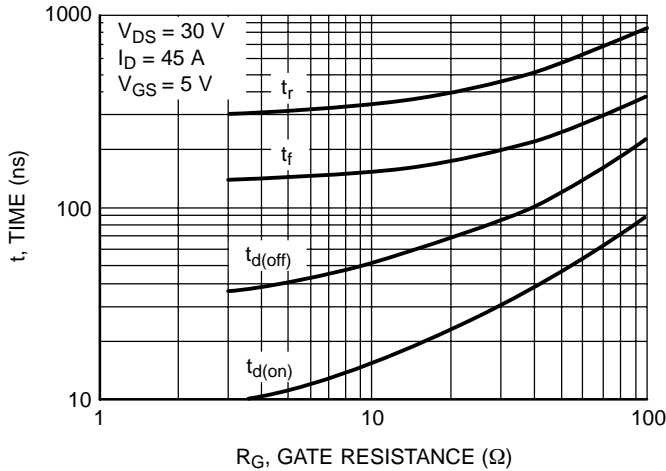

Figure 9. Resistive Switching Time Variation vs. Gate Resistance

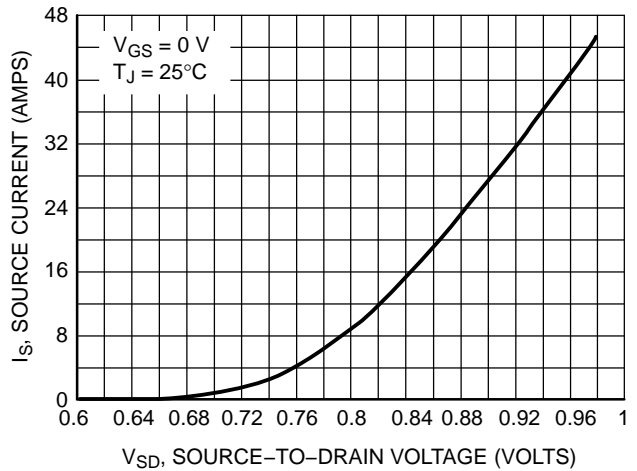

Figure 10. Diode Forward Voltage vs. Current

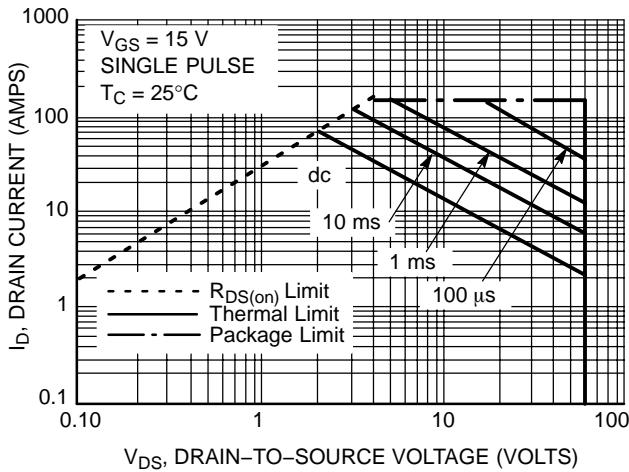

Figure 11. Maximum Rated Forward Biased Safe Operating Area

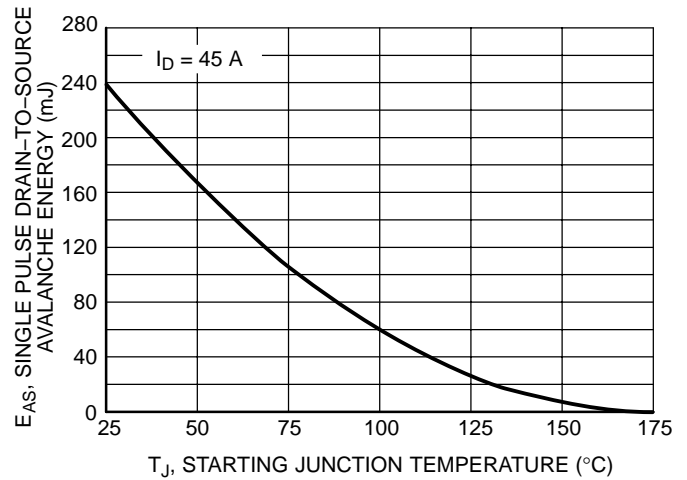

Figure 12. Maximum Avalanche Energy vs. Starting Junction Temperature

NTP45N06L, NTB45N06L

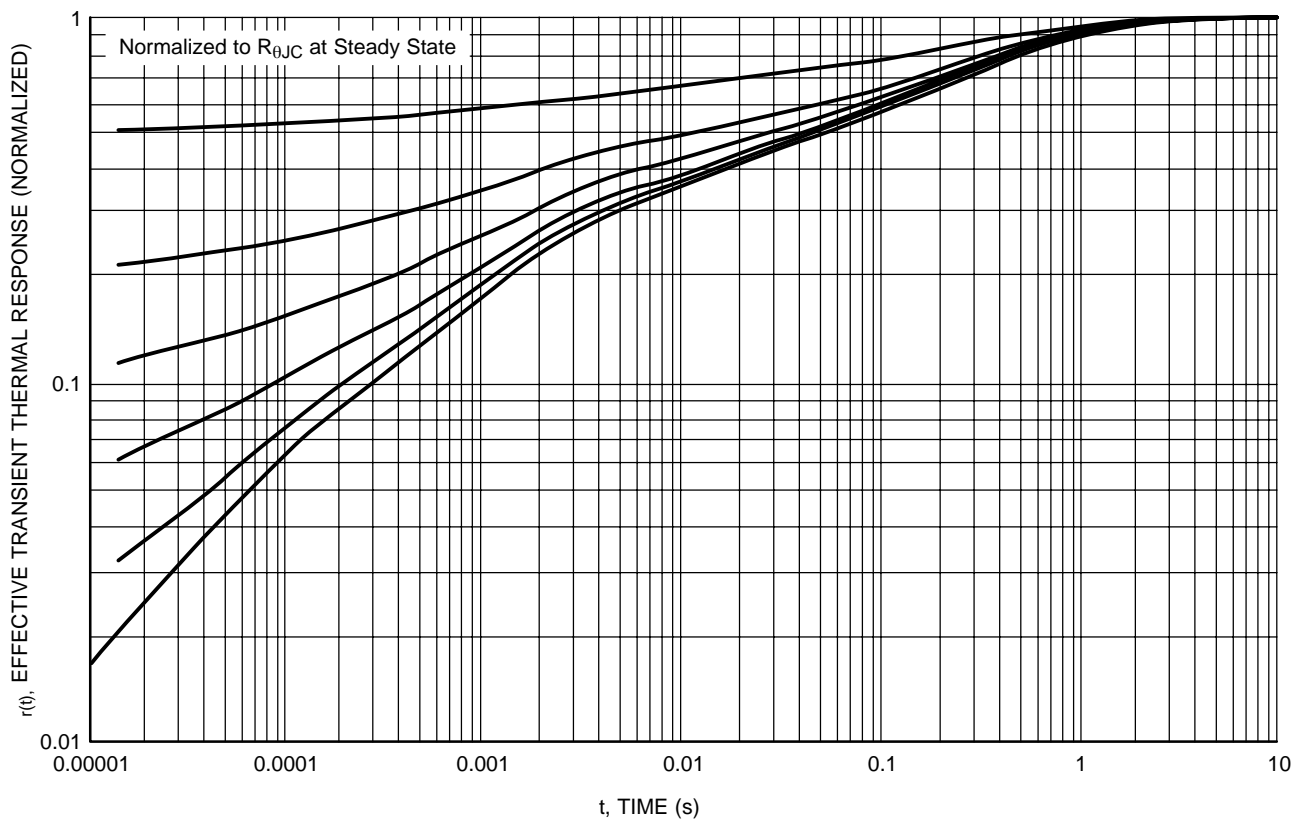

Figure 13. Thermal Response

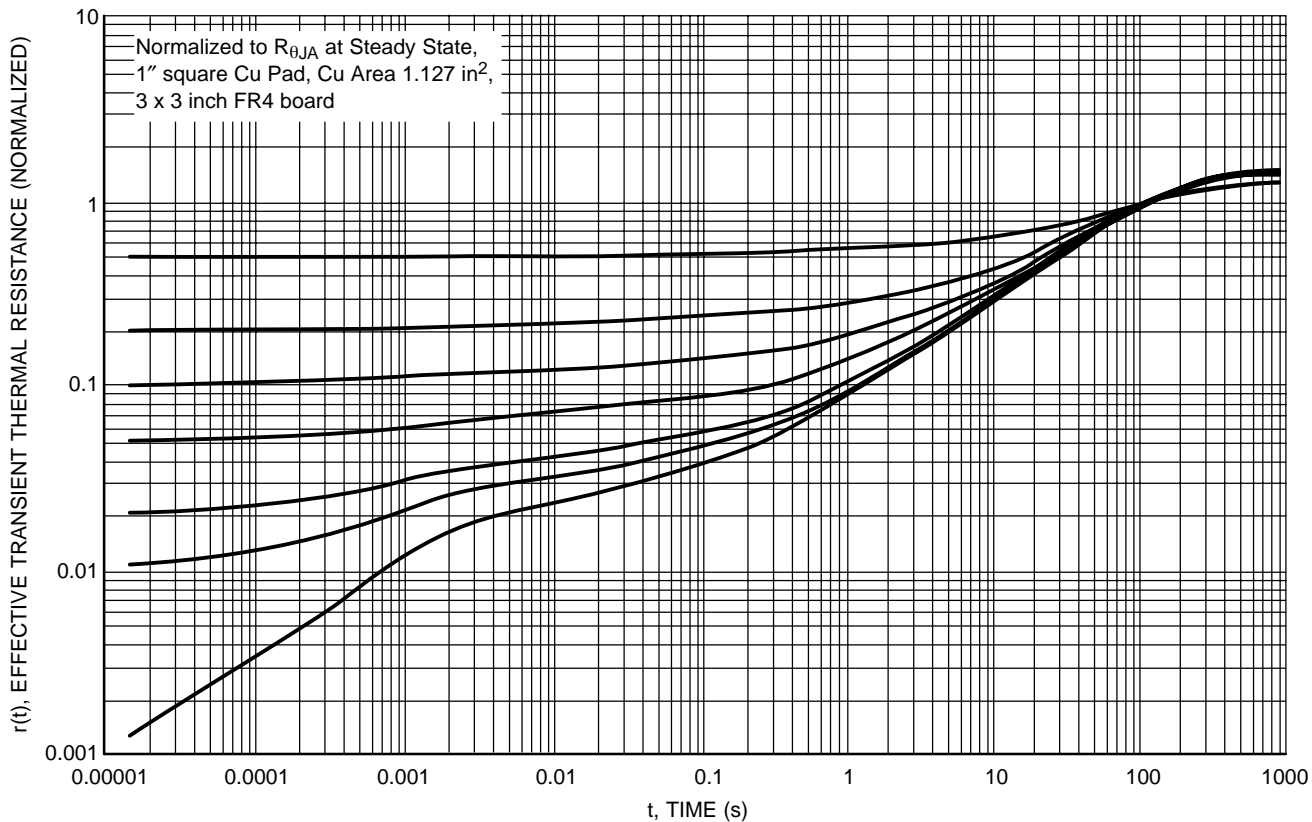
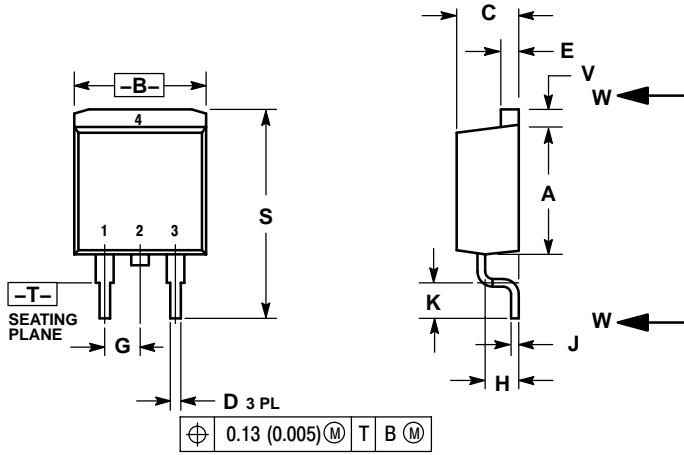

Figure 14. Thermal Response

NTP45N06L, NTB45N06L

PACKAGE DIMENSIONS

D²PAK
CASE 418B-04
ISSUE J



NOTES:

1. DIMENSIONING AND TOLERANCING PER ANSI Y14.5M, 1982.
2. CONTROLLING DIMENSION: INCH.
3. 418B-01 THRU 418B-03 OBSOLETE, NEW STANDARD 418B-04.

DIM	INCHES		MILLIMETERS	
	MIN	MAX	MIN	MAX
A	0.340	0.380	8.64	9.65
B	0.380	0.405	9.65	10.29
C	0.160	0.190	4.06	4.83
D	0.020	0.035	0.51	0.89
E	0.045	0.055	1.14	1.40
F	0.310	0.350	7.87	8.89
G	0.100 BSC		2.54 BSC	
H	0.080	0.110	2.03	2.79
J	0.018	0.025	0.46	0.64
K	0.090	0.110	2.29	2.79
L	0.052	0.072	1.32	1.83
M	0.280	0.320	7.11	8.13
N	0.197 REF		5.00 REF	
P	0.079 REF		2.00 REF	
R	0.039 REF		0.99 REF	
S	0.575	0.625	14.60	15.88
V	0.045	0.055	1.14	1.40

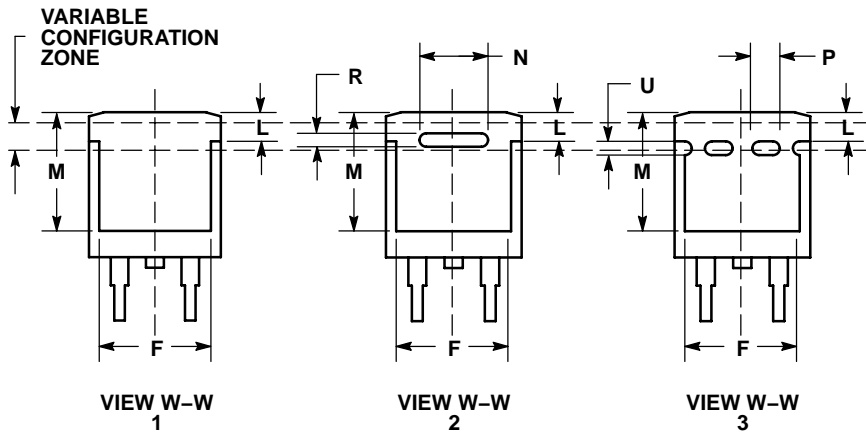

STYLE 2:

- PIN 1. GATE
- DRAIN
- SOURCE
- DRAIN

SOLDERING FOOTPRINT*

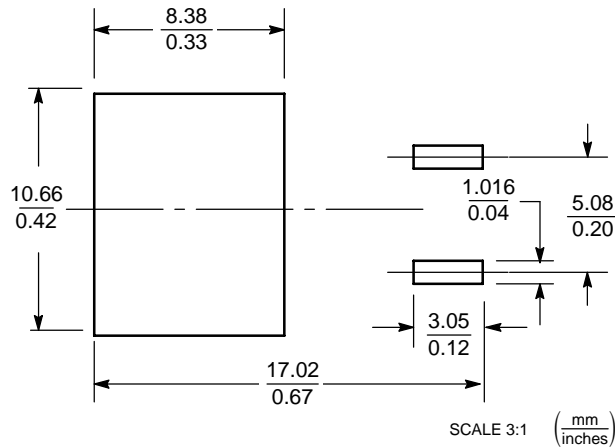

*For additional information on our Pb-Free strategy and soldering details, please download the ON Semiconductor Soldering and Mounting Techniques Reference Manual, SOLDERRM/D.

NTP45N06L, NTB45N06L

PACKAGE DIMENSIONS

TO-220
CASE 221A-09
ISSUE AA

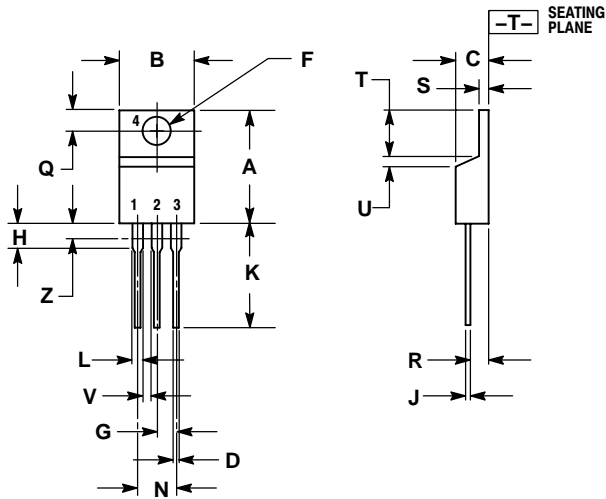

NOTES:

1. DIMENSIONING AND TOLERANCING PER ANSI Y14.5M, 1982.
2. CONTROLLING DIMENSION: INCH.
3. DIMENSION Z DEFINES A ZONE WHERE ALL BODY AND LEAD IRREGULARITIES ARE ALLOWED.

DIM	INCHES		MILLIMETERS	
	MIN	MAX	MIN	MAX
A	0.570	0.620	14.48	15.75
B	0.380	0.405	9.66	10.28
C	0.160	0.190	4.07	4.82
D	0.025	0.035	0.64	0.88
F	0.142	0.147	3.61	3.73
G	0.095	0.105	2.42	2.66
H	0.110	0.155	2.80	3.93
J	0.018	0.025	0.46	0.64
K	0.500	0.562	12.70	14.27
L	0.045	0.060	1.15	1.52
N	0.190	0.210	4.83	5.33
Q	0.100	0.120	2.54	3.04
R	0.080	0.110	2.04	2.79
S	0.045	0.055	1.15	1.39
T	0.235	0.255	5.97	6.47
U	0.000	0.050	0.00	1.27
V	0.045	---	1.15	---
Z	---	0.080	---	2.04

STYLE 5:

- PIN 1. GATE
2. DRAIN
3. SOURCE
4. DRAIN

ON Semiconductor and are registered trademarks of Semiconductor Components Industries, LLC (SCILLC). SCILLC reserves the right to make changes without further notice to any products herein. SCILLC makes no warranty, representation or guarantee regarding the suitability of its products for any particular purpose, nor does SCILLC assume any liability arising out of the application or use of any product or circuit, and specifically disclaims any and all liability, including without limitation special, consequential or incidental damages. "Typical" parameters which may be provided in SCILLC data sheets and/or specifications can and do vary in different applications and actual performance may vary over time. All operating parameters, including "Typicals" must be validated for each customer application by customer's technical experts. SCILLC does not convey any license under its patent rights nor the rights of others. SCILLC products are not designed, intended, or authorized for use as components in systems intended for surgical implant into the body, or other applications intended to support or sustain life, or for any other application in which the failure of the SCILLC product could create a situation where personal injury or death may occur. Should Buyer purchase or use SCILLC products for any such unintended or unauthorized application, Buyer shall indemnify and hold SCILLC and its officers, employees, subsidiaries, affiliates, and distributors harmless against all claims, costs, damages, and expenses, and reasonable attorney fees arising out of, directly or indirectly, any claim of personal injury or death associated with such unintended or unauthorized use, even if such claim alleges that SCILLC was negligent regarding the design or manufacture of the part. SCILLC is an Equal Opportunity/Affirmative Action Employer. This literature is subject to all applicable copyright laws and is not for resale in any manner.

PUBLICATION ORDERING INFORMATION

LITERATURE FULFILLMENT:
Literature Distribution Center for ON Semiconductor
P.O. Box 61312, Phoenix, Arizona 85082-1312 USA
Phone: 480-829-7710 or 800-344-3860 Toll Free USA/Canada
Fax: 480-829-7709 or 800-344-3867 Toll Free USA/Canada
Email: orderlit@onsemi.com

N. American Technical Support: 800-282-9855 Toll Free USA/Canada

Japan: ON Semiconductor, Japan Customer Focus Center
2-9-1 Kamimeguro, Meguro-ku, Tokyo, Japan 153-0051
Phone: 81-3-5773-3850

ON Semiconductor Website: <http://onsemi.com>

Order Literature: <http://www.onsemi.com/litorder>

For additional information, please contact your local Sales Representative.