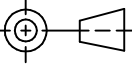

PAGE #	TITLE	REV. #	DATE
1	INDEX	A	10/16/02
2	RATINGS, RELIABILITY, OPERATING	A	10/16/02
3	DIMENSIONS	A	10/16/02
LOAD CHARACTERISTICS DATA			
4	NDL-102	A	10/16/02
5	NDL-104	A	10/16/02
6	NDL-106	A	10/16/02
7	NDL-206	A	10/16/02
8	NDL-208	A	10/16/02
9	NDL-210	A	10/16/02
10	NDL-212	A	10/16/02
11	NDL-217	A	10/16/02
12	NDL-201	A	10/16/02
13	NDL-202	A	10/16/02
14	NDL-203	A	10/16/02
15	NDL-204	A	10/16/02
16	NDL-205	A	10/16/02

METRIC		DIMENSIONS ARE IN MILLIMETERS		JKL COMPONENTS CORPORATION			
		TOLERANCE UNLESS OTHERWISE SPECIFIED		TITLE			
THIRD ANGLE PROJECTION		1 PL +/- REF. 2 PL +/- ANGLE +/-		NDL LOAD CHARACTERISTICS DATA			
DRAWN BY		APPV'D BY DATE		SIZE	FSCM NO.	DRAWING NO.	
L. WENGSTROM		F.D. 10/16/02		A	55335	NDL SERIES	
- CAD DRAWING -				SCALE	RELEASED DATE	REVISION DATE	REV. NO.
MANUAL REVISIONS NOT PERMITTED				NONE	10/16/02		A
REV. NO.	DESCRIPTION/ECONUMBER	APPV'D DATE			RELEASED DATE	REVISION DATE	SHEET
A	RELEASED	10/16/02			10/16/02		1 OF 16

MAXIMUM RATINGS

ITEMS	MAXIMUM RATINGS	OPERATING RANGE
Input voltage	6 V dc	3.0 to 5.5 V dc
Operating temperature	-10 to 50°	
Storage temperature	-20 to 70°	

RELIABILITY TEST ITEMS

ITEMS	CONDITIONS	NOTES
Temperature shock	-20/70°C for 1 hour each, 10 cycles	1, 2, 3
Soldering heat resistance	260°C 10 seconds	1, 2, 3
Lead strength	1KG 10 seconds	1, 2, 3
Vibration	Frequency = 10 to 55 Hz, amplitude = 1.5mm (1 hour for each direction of X, Y, Z) sweep time = 1 minute/cycle	1, 2, 3

NOTES: 1. The changed values of input current, output voltage and output frequency must be within 10% of their initial values.
2. No significant change or abnormality in external appearance must occur.
3. Dimensions must conform to specifications.

RELIABILITY TEST ITEMS

PART NUMBER	RECOMMENDED ELEMENT AREA (cm ²)	NOMINAL VALUE			
		LOAD AREA (cm ²)	BRIGHTNESS (cd/m ²)	FREQUENCY (Hz)	OUTPUT VOLTAGE (Vrms)
NDL-102	20 to 30	25			
NDL-104	25 to 40	33			
NDL-106	40 to 80	60			
NDL-206	40 to 100	70	80 to 100	500 to 600	80 to 120
NDL-208	60 to 140	90			
NDL-210	70 to 100	85			
NDL-212	80 to 120	100			
NDL-217	100 to 170	135			
NDL-201	10 to 19	15	40 to 60	450 to 550	70 to 90
NDL-202	19 to 38	28			
NDL-203	25 to 43	34			
NDL-204	41 to 70	56			
NDL-205	50 to 83	66			

NDL-102, NDL-104

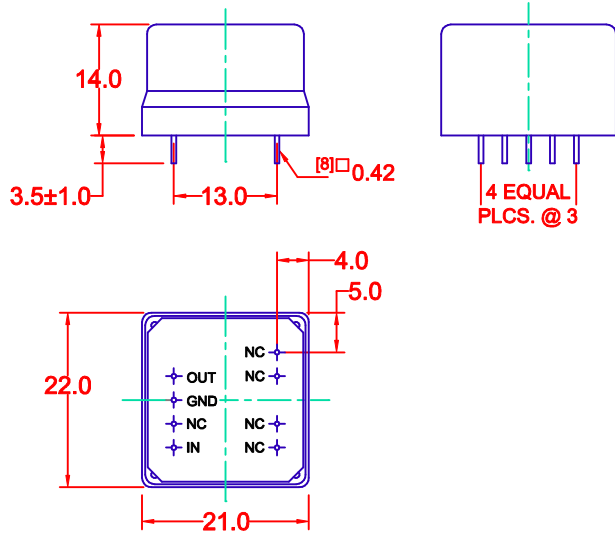

NDL-106

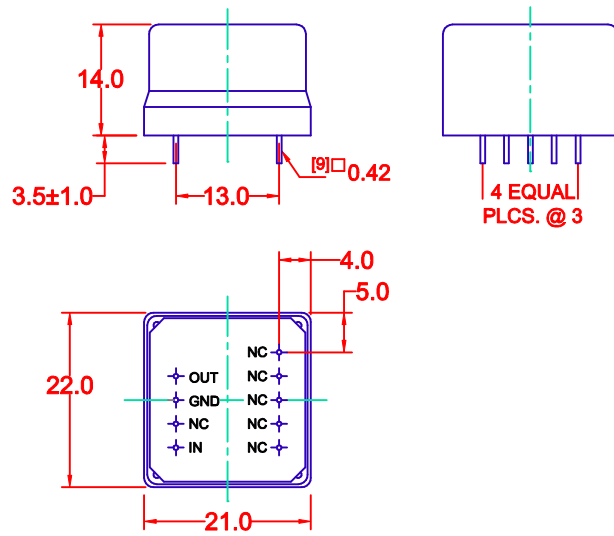

NDL-206, NDL-208, NDL-210, NDL-212

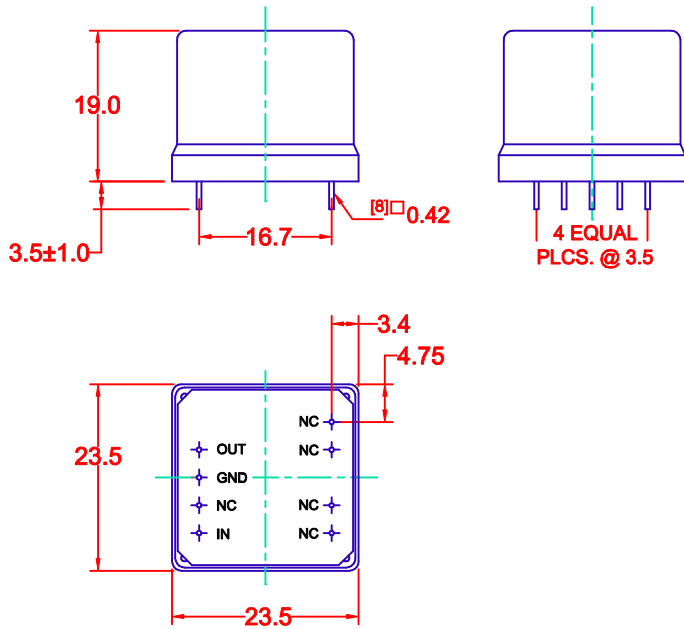

NDL-217

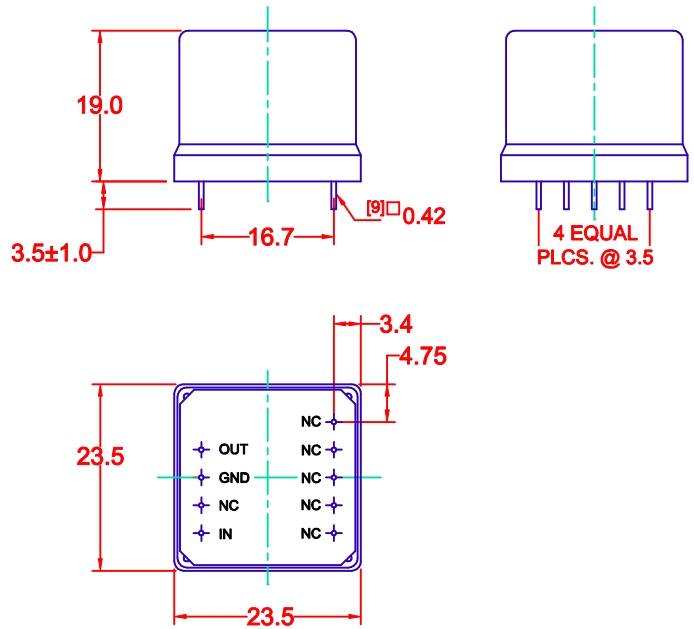

NDL-201 TO 205

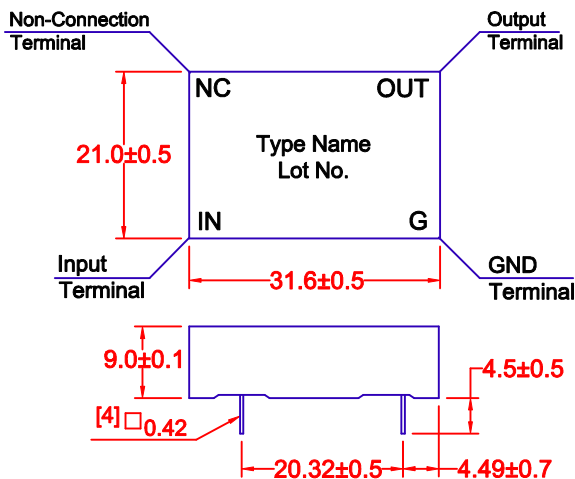

**P.C.B. DRILLING
ON ALL SERIES
Ø1.07mm (0.042")
PTH AFTER PLATING**

LOAD CHARACTERISTICS DATA

INVERTER: NDL-102

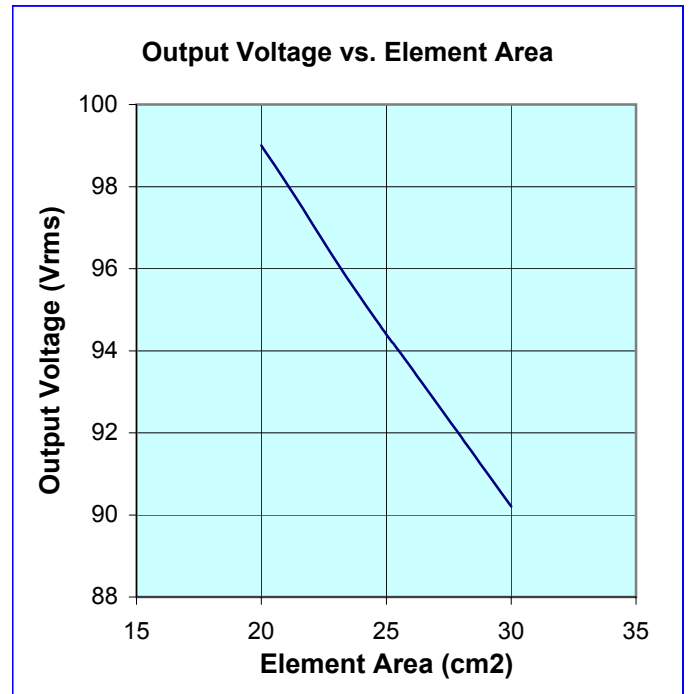
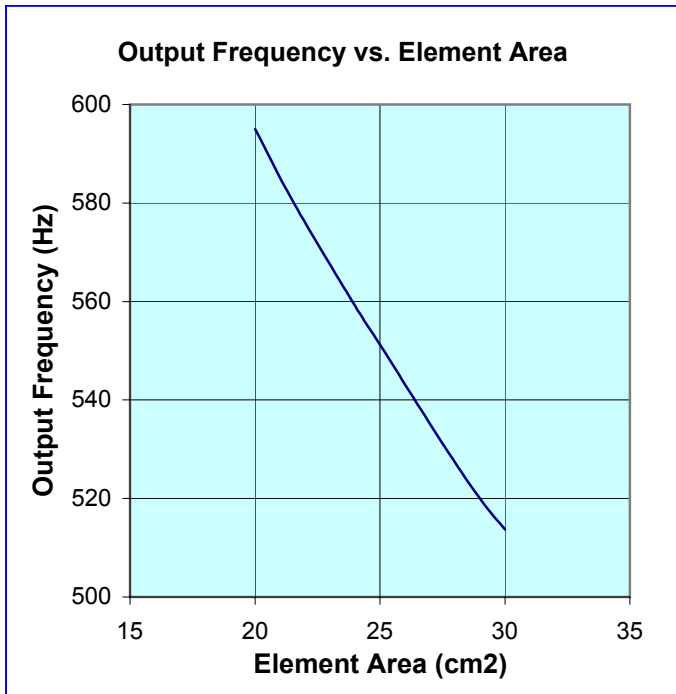
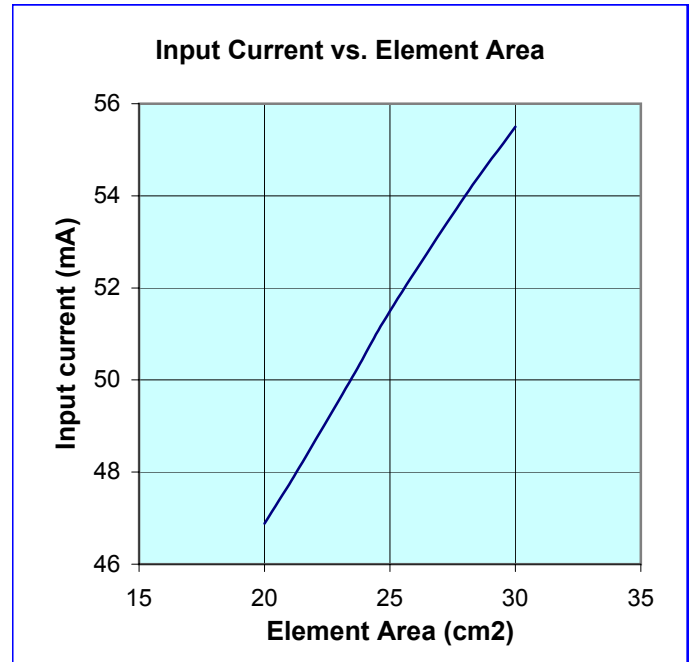
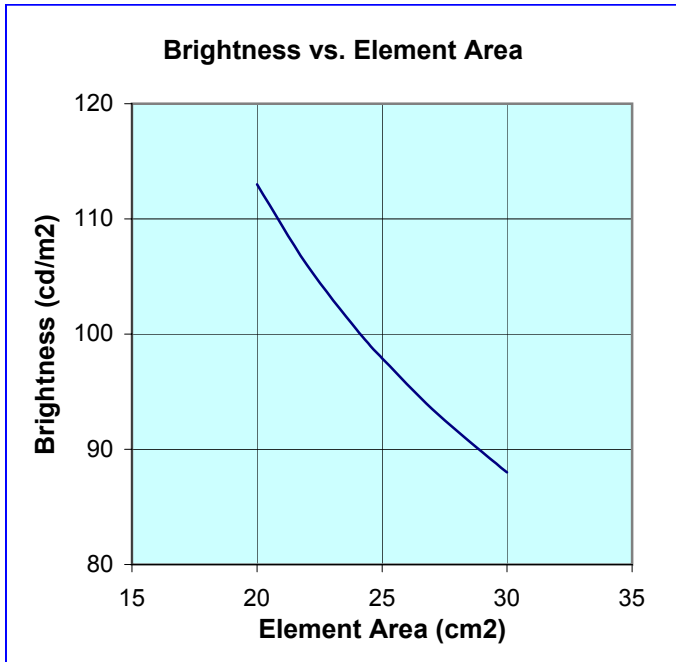

LOAD CHARACTERISTICS DATA

INVERTER: NDL-104

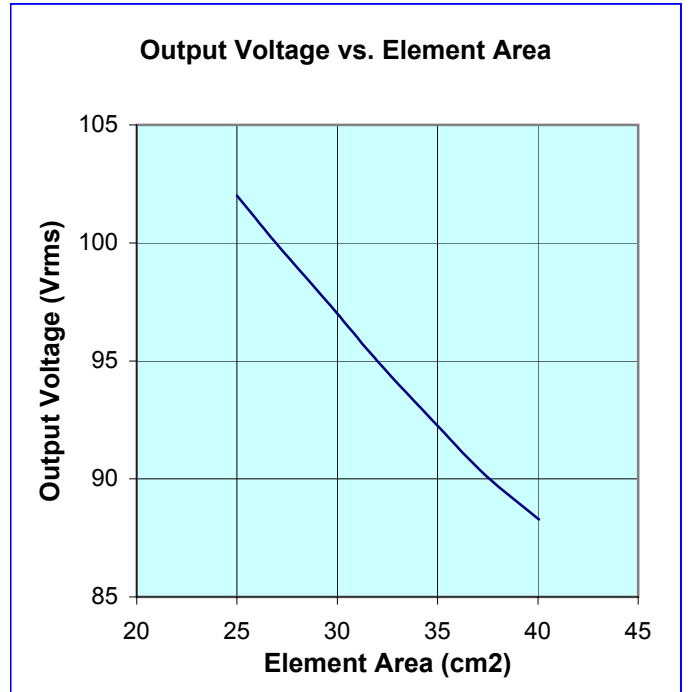
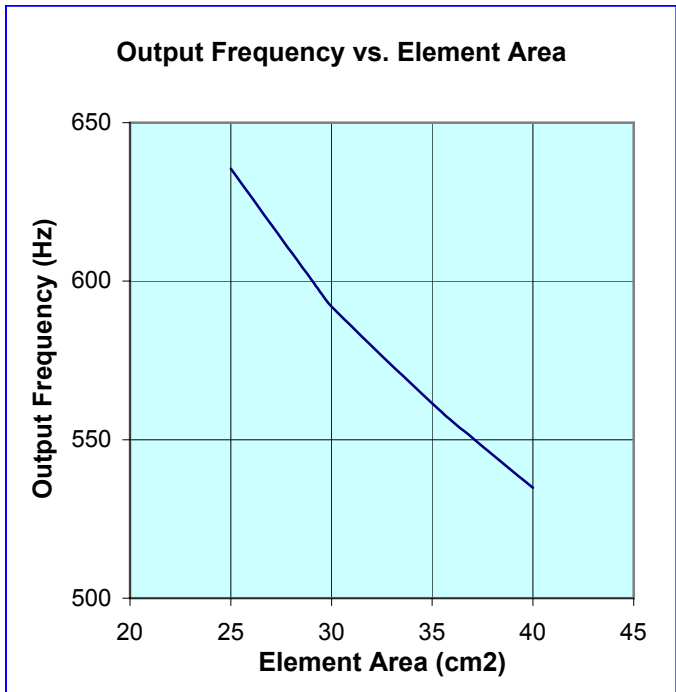
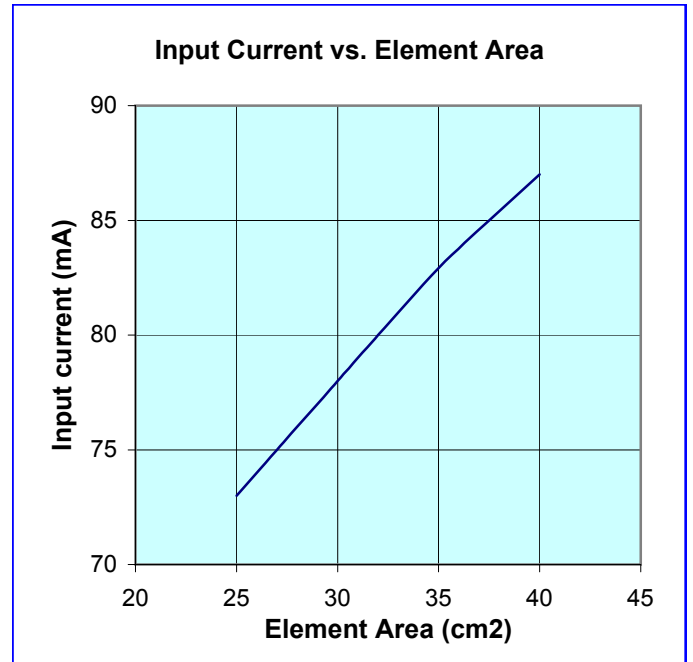
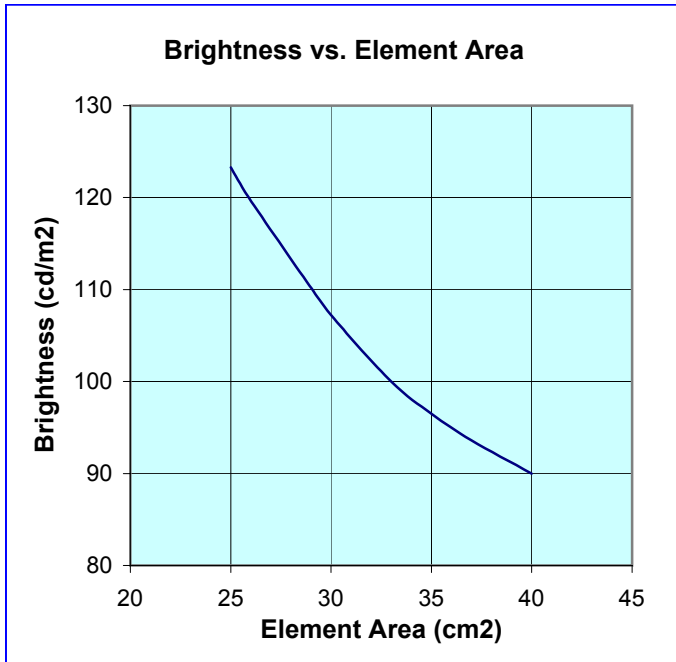

LOAD CHARACTERISTICS DATA

INVERTER: NDL-106

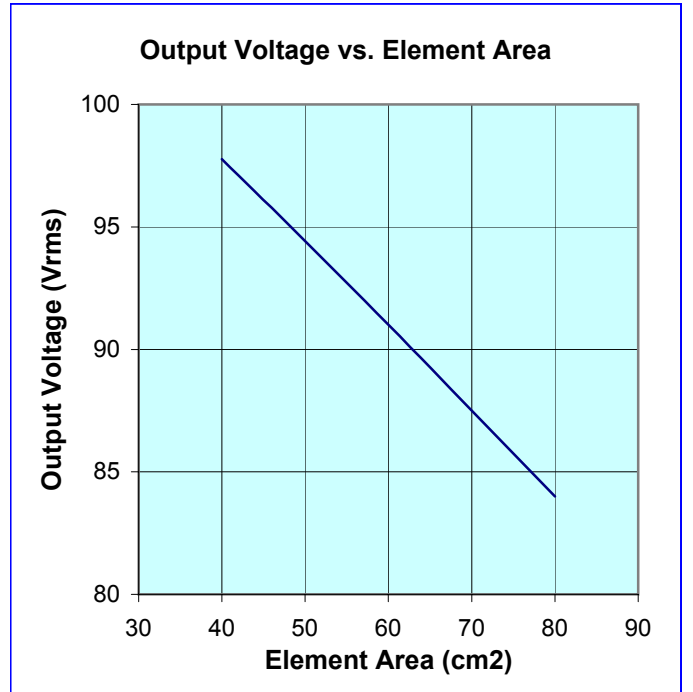
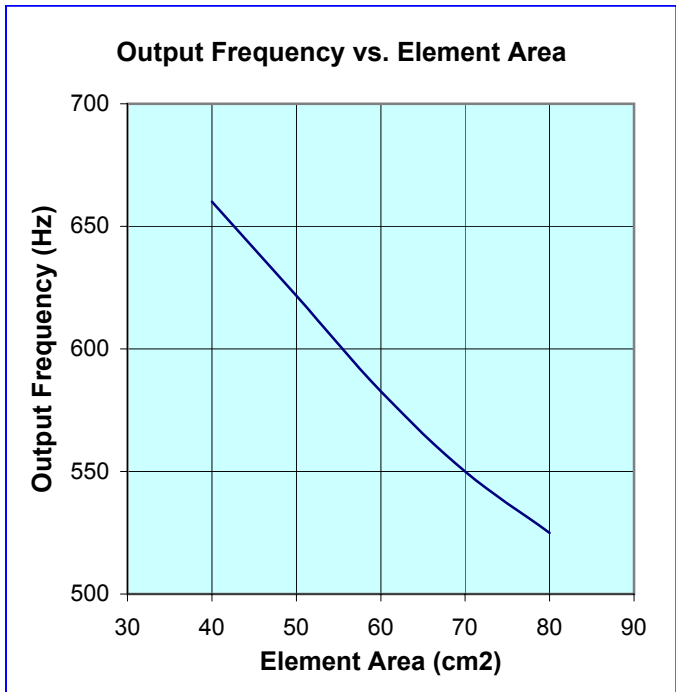
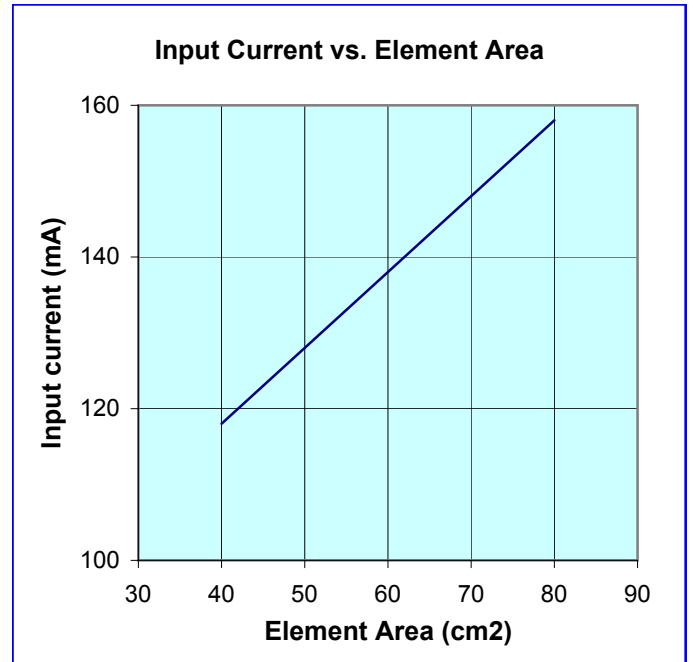
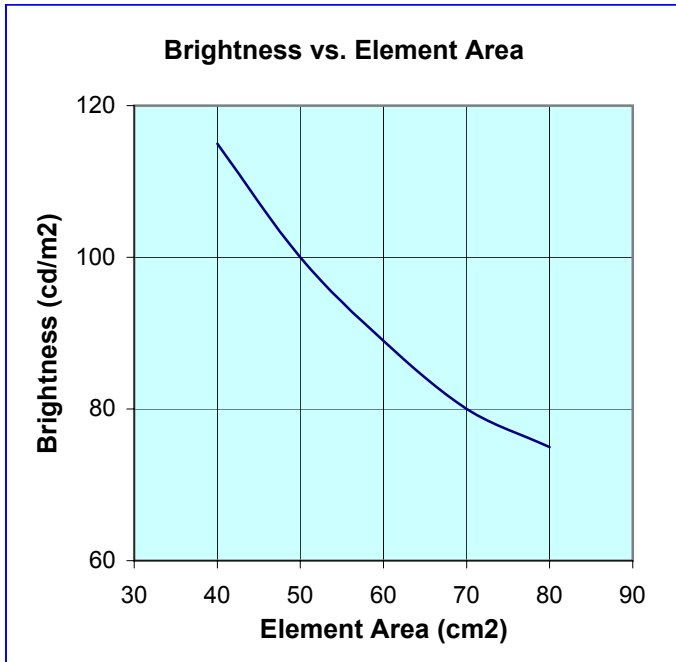

LOAD CHARACTERISTICS DATA

INVERTER: NDL-206

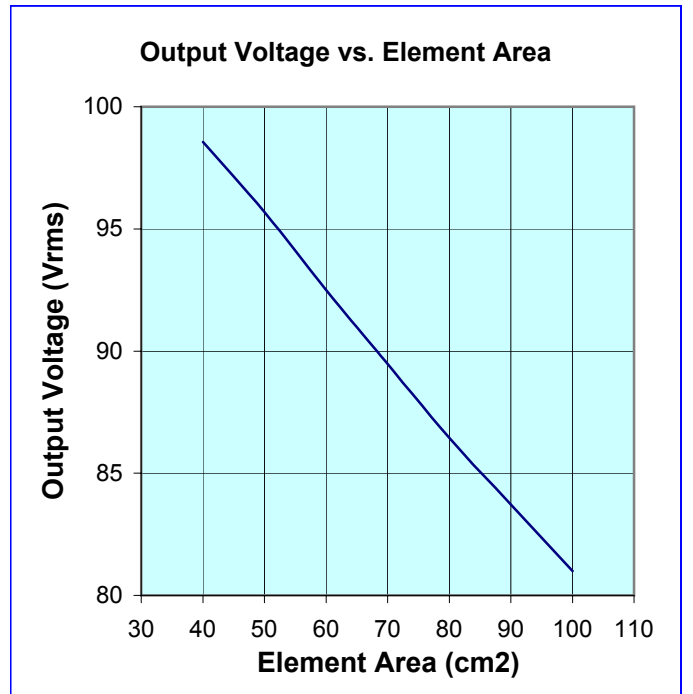
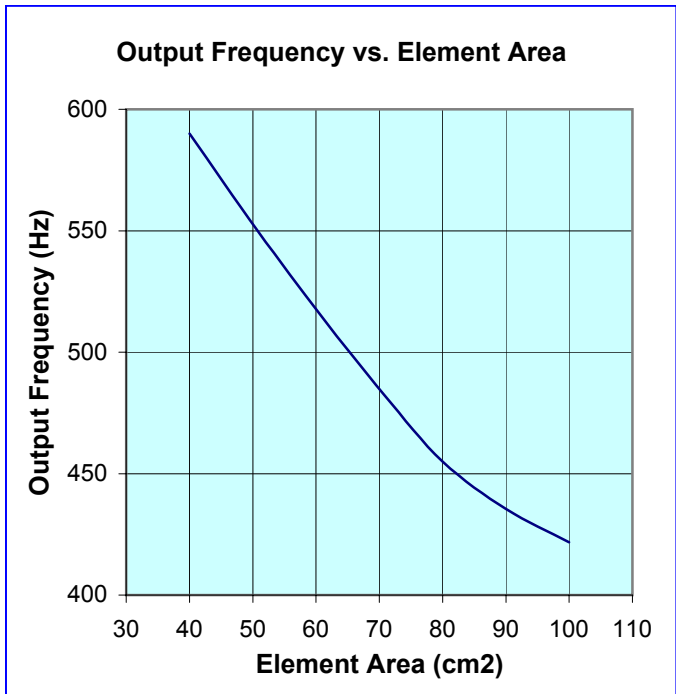
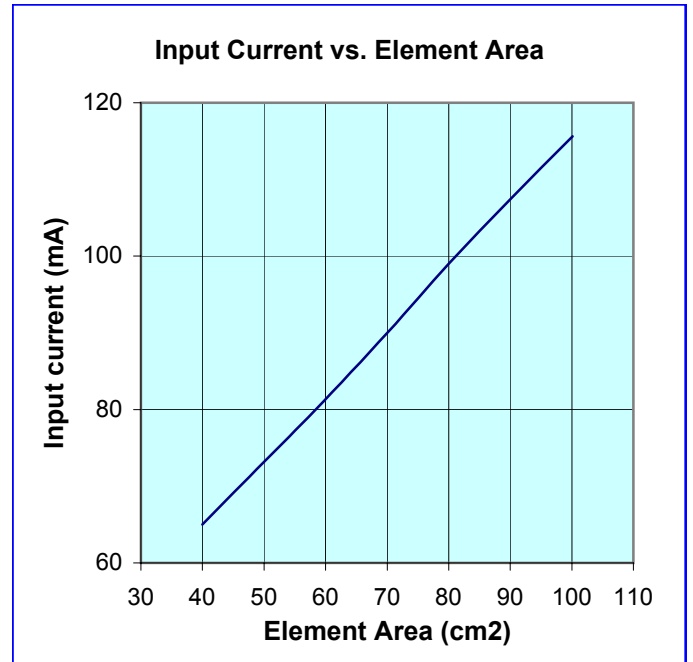
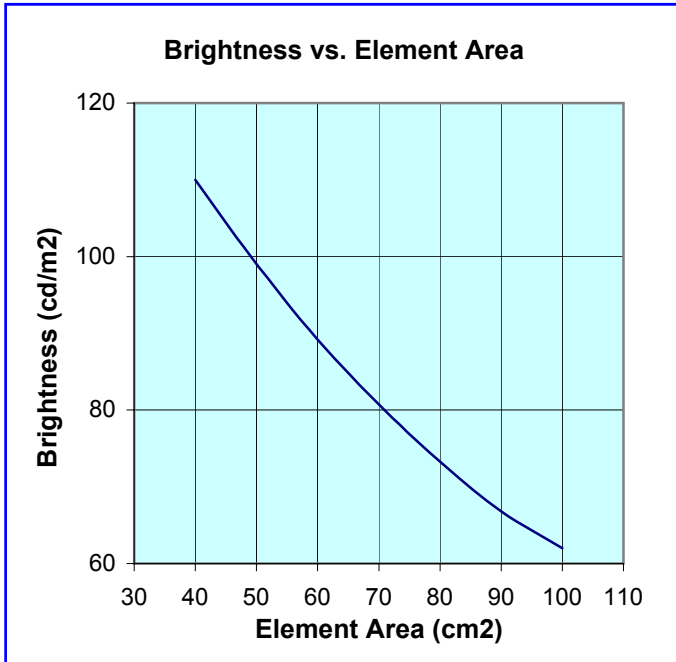

LOAD CHARACTERISTICS DATA

INVERTER: NDL-208

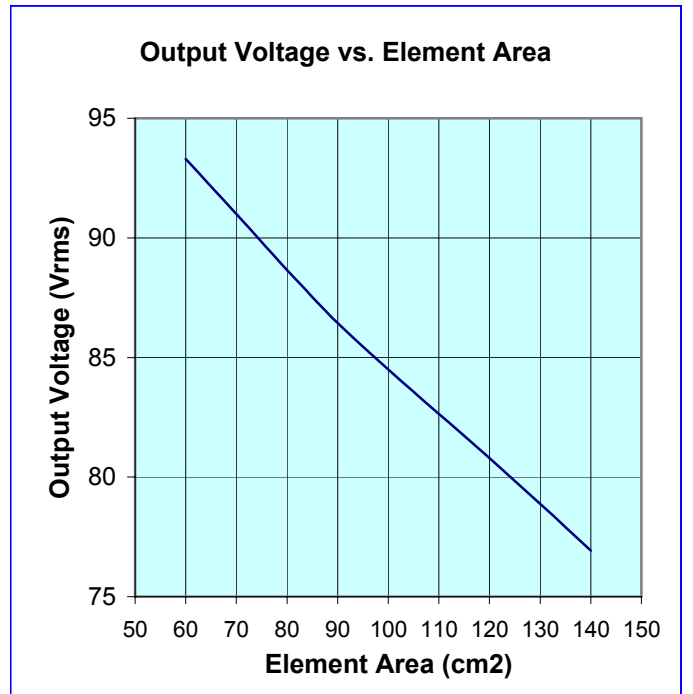
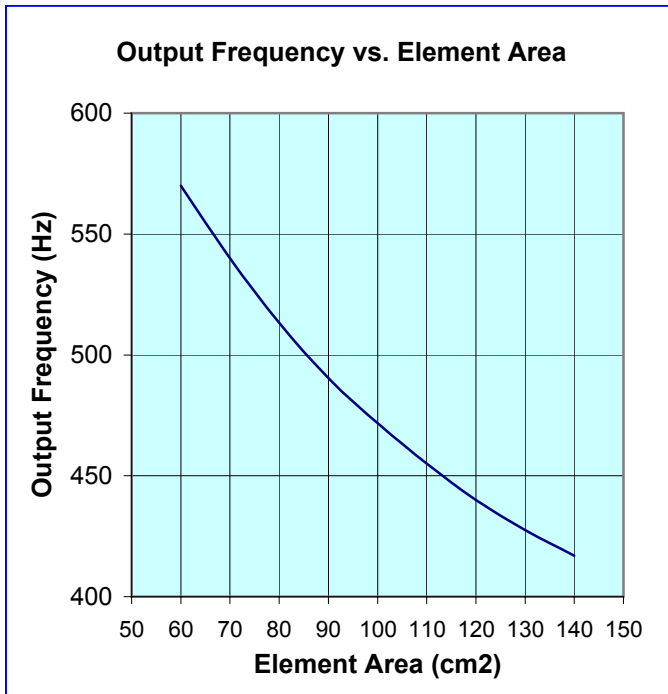
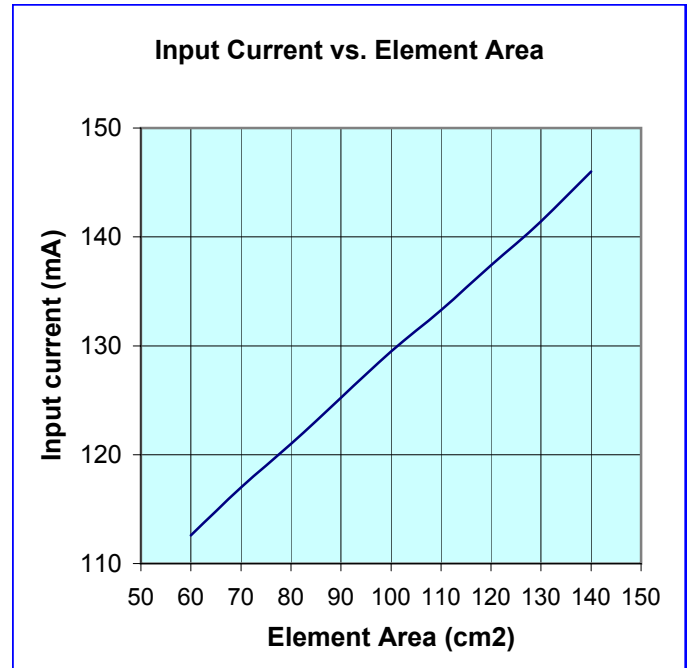
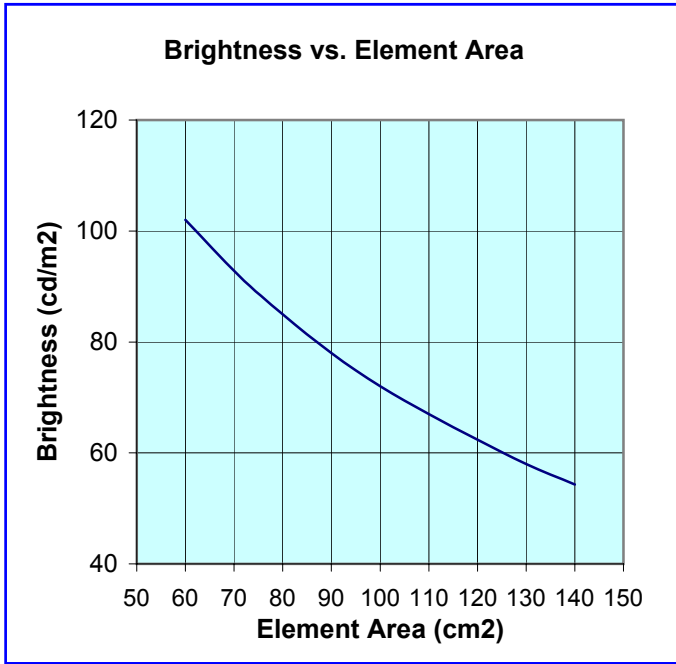

LOAD CHARACTERISTICS DATA

INVERTER: NDL-210

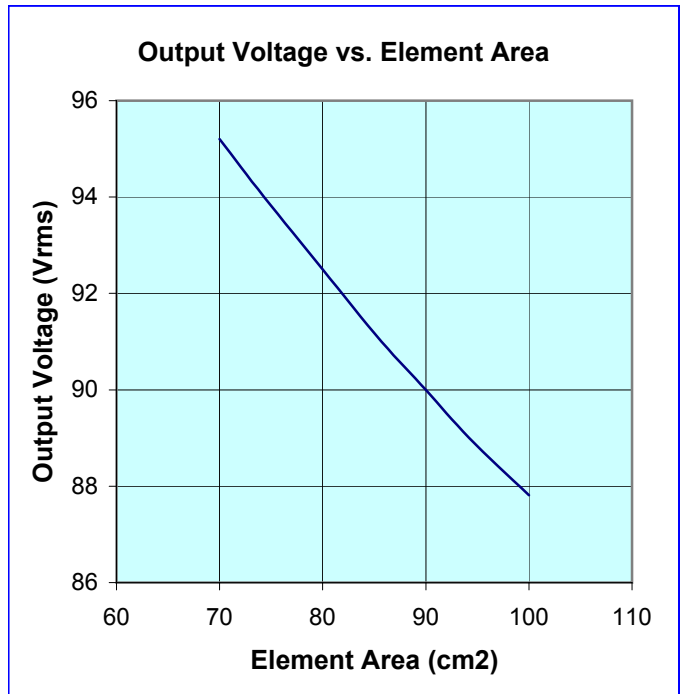
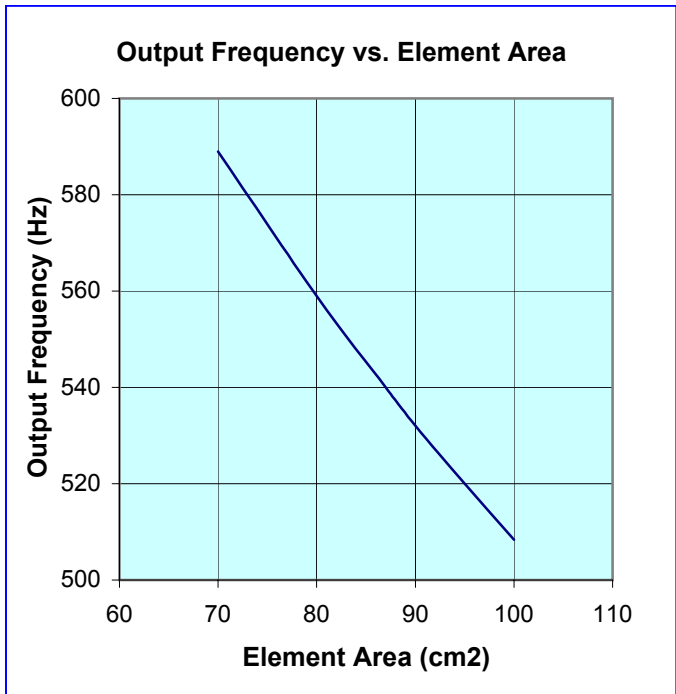
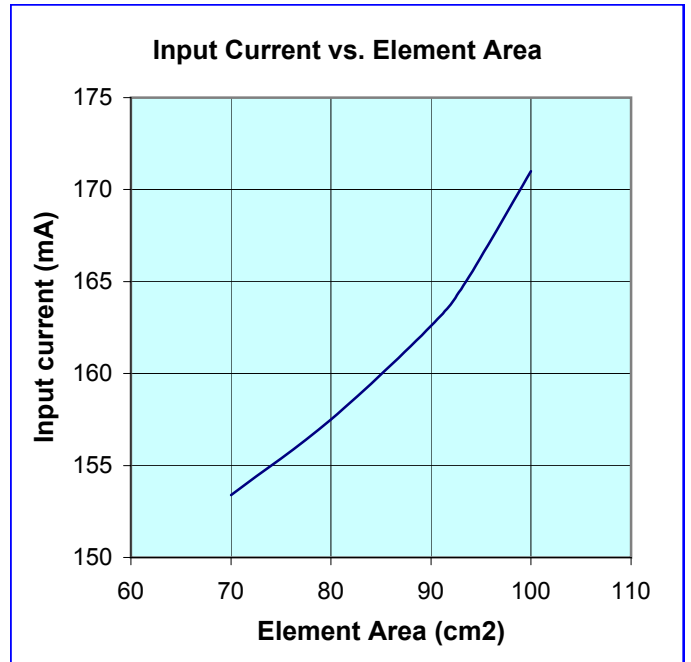
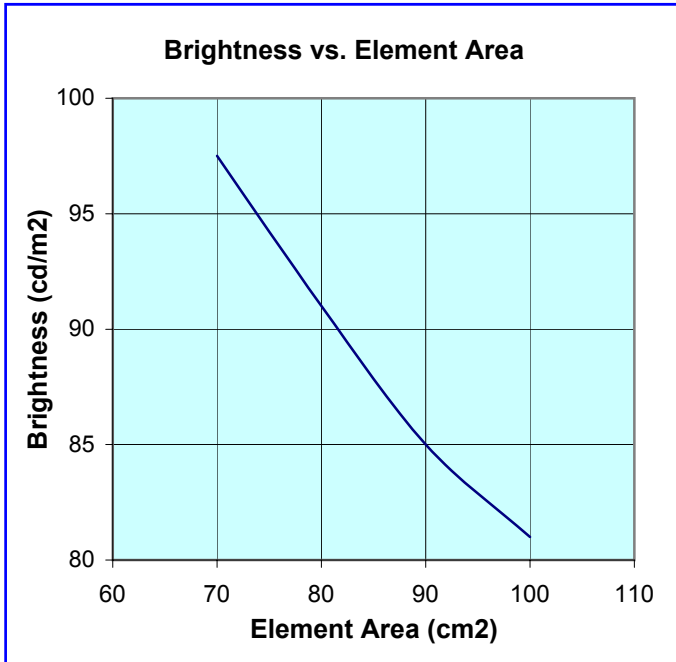

LOAD CHARACTERISTICS DATA

INVERTER: NDL-212

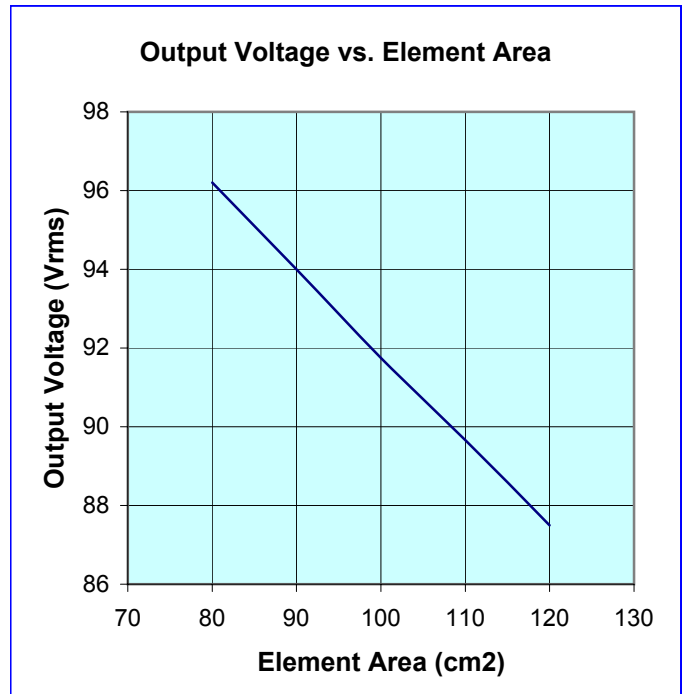
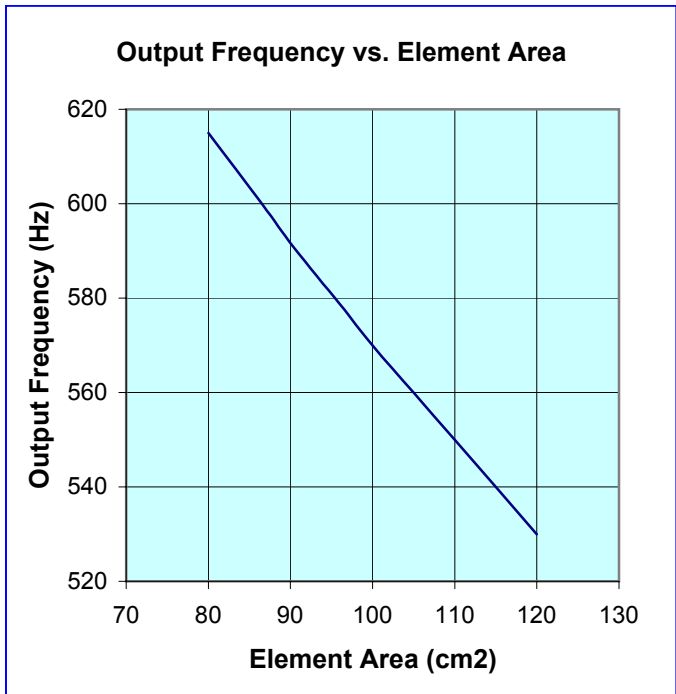
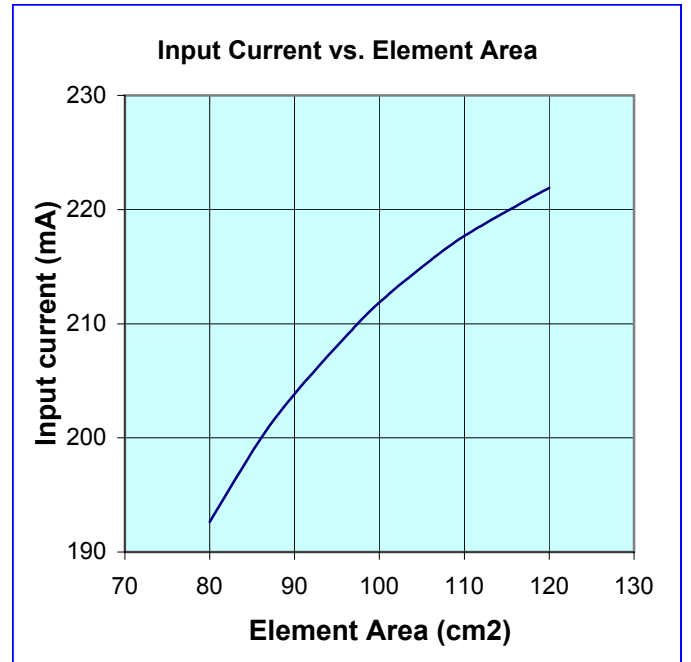
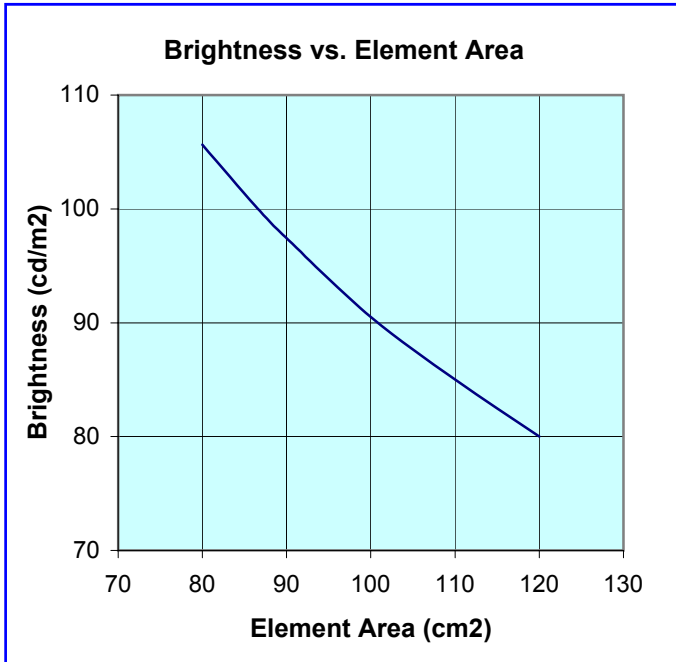

LOAD CHARACTERISTICS DATA

INVERTER: NDL-217

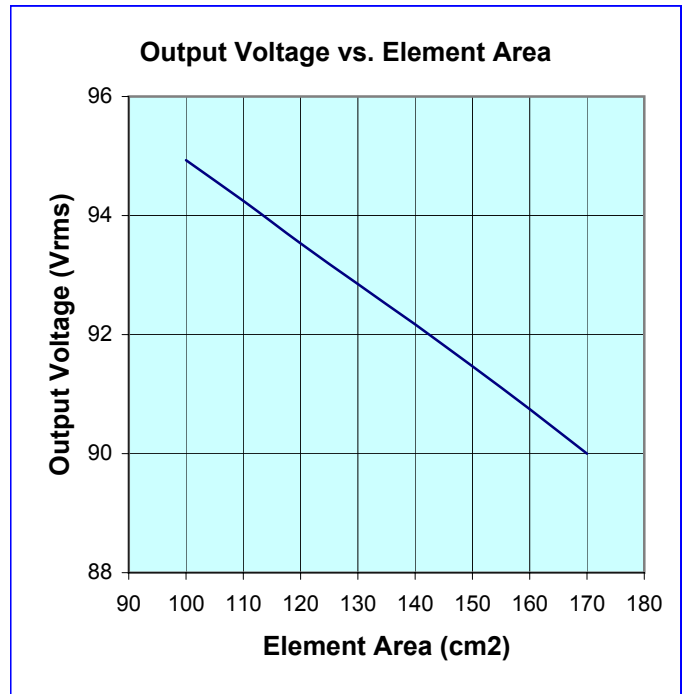
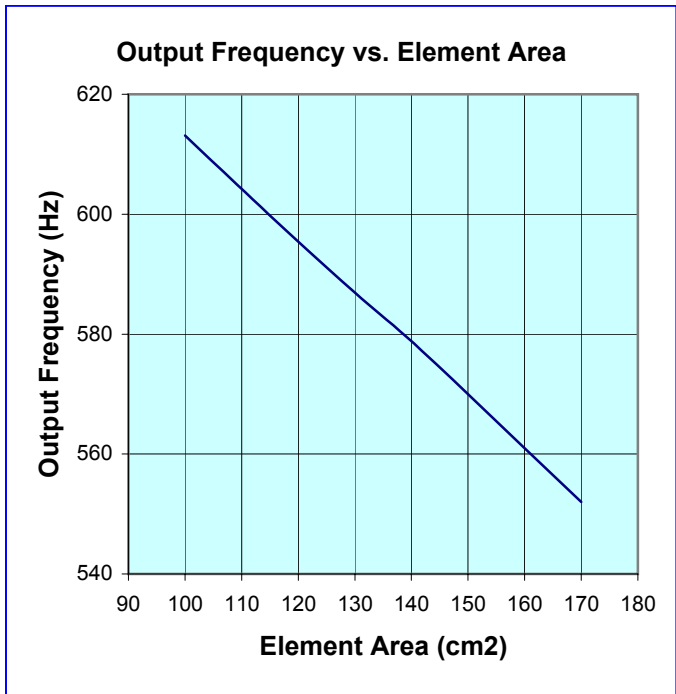
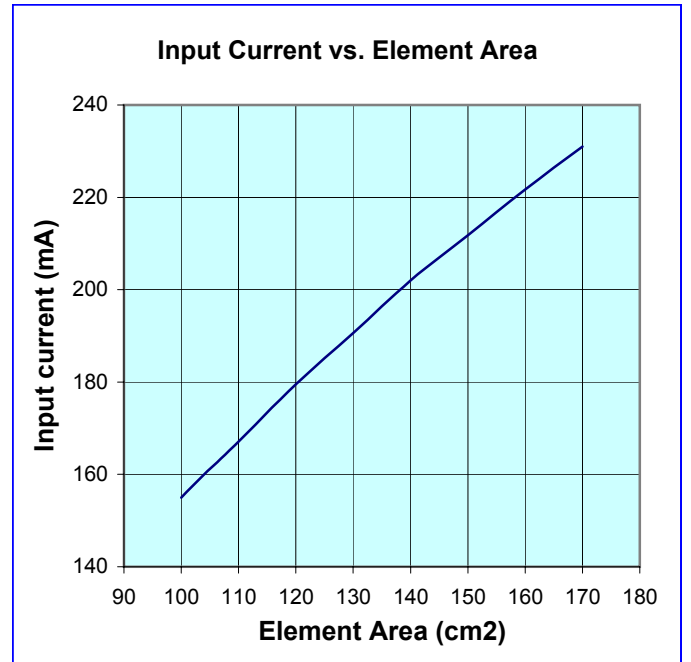
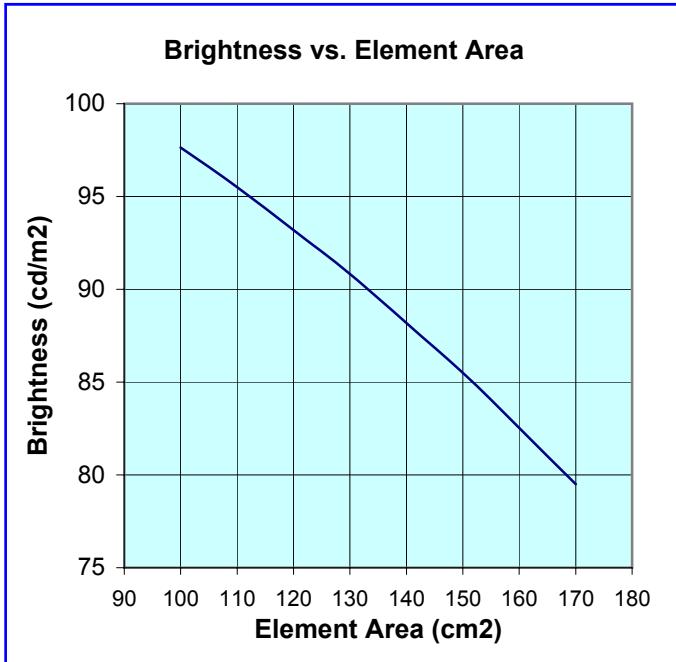

LOAD CHARACTERISTICS DATA

INVERTER: NDL-201

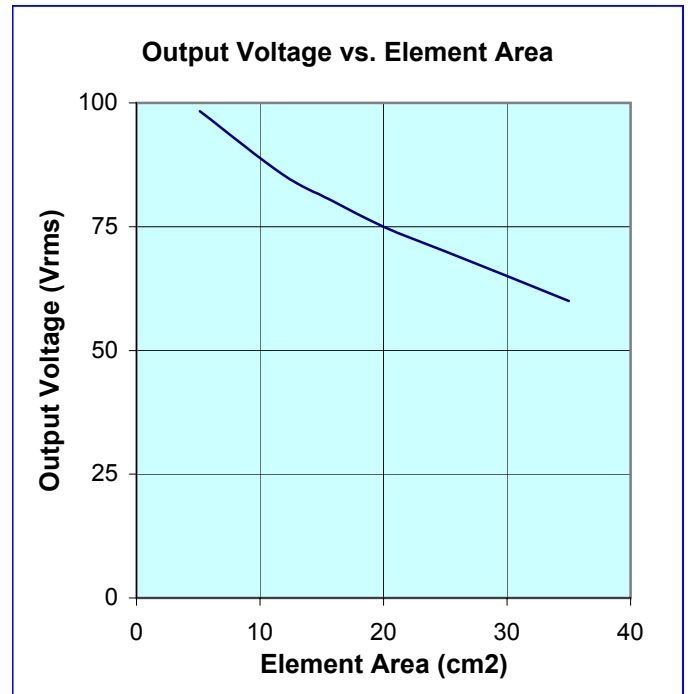
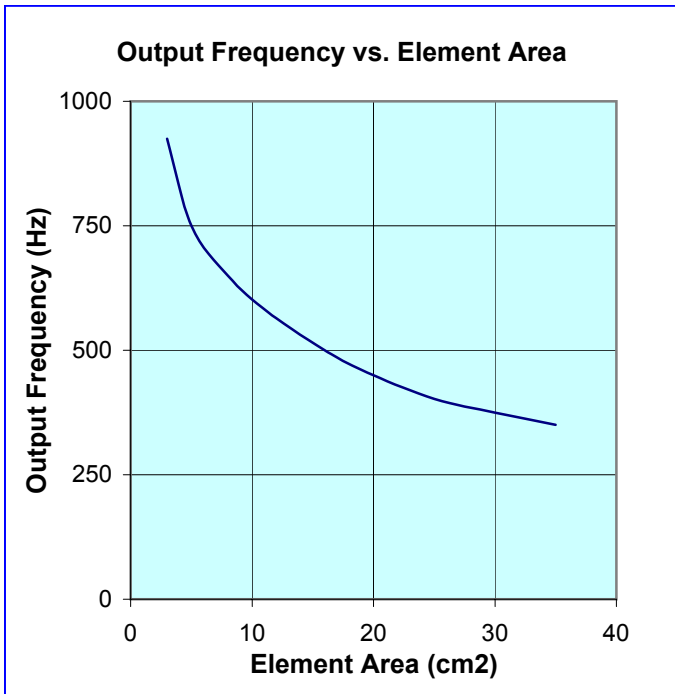
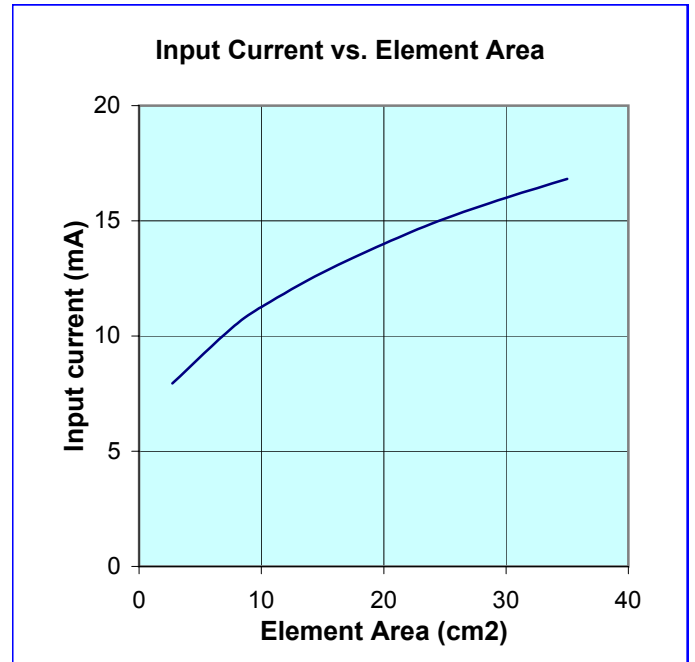
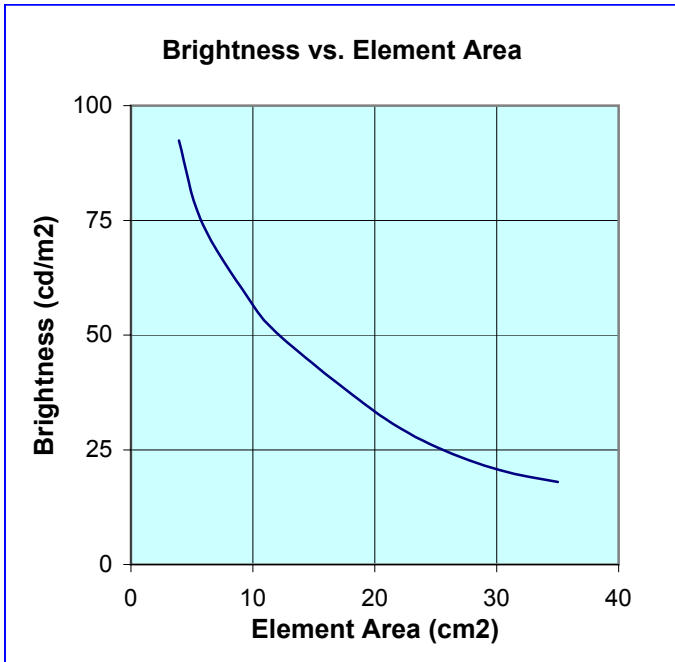

LOAD CHARACTERISTICS DATA

INVERTER: NDL-202

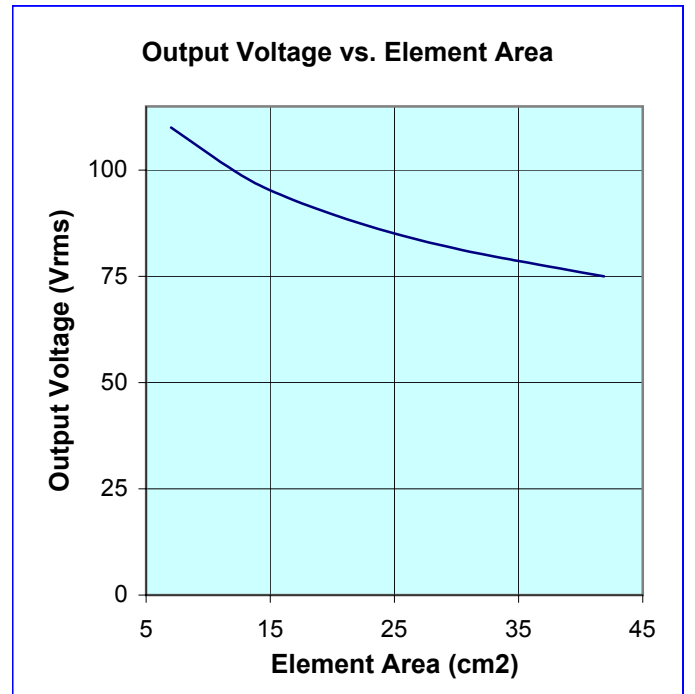
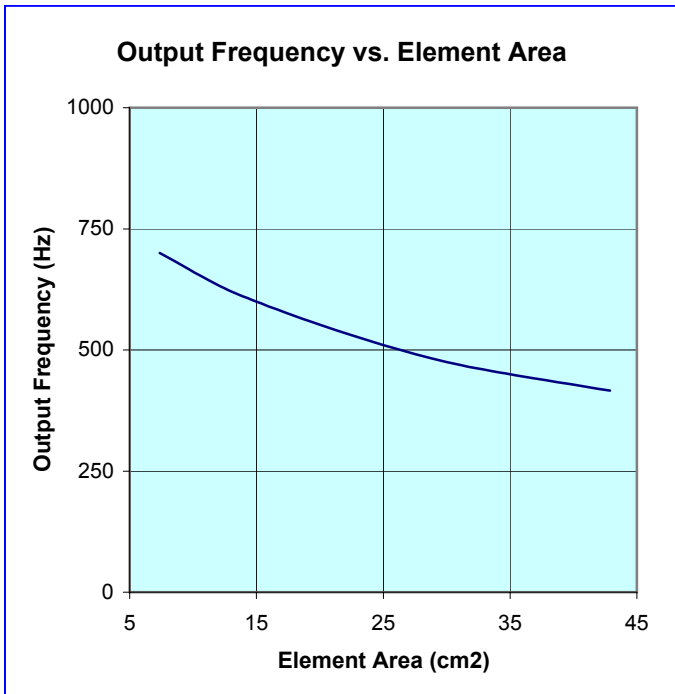
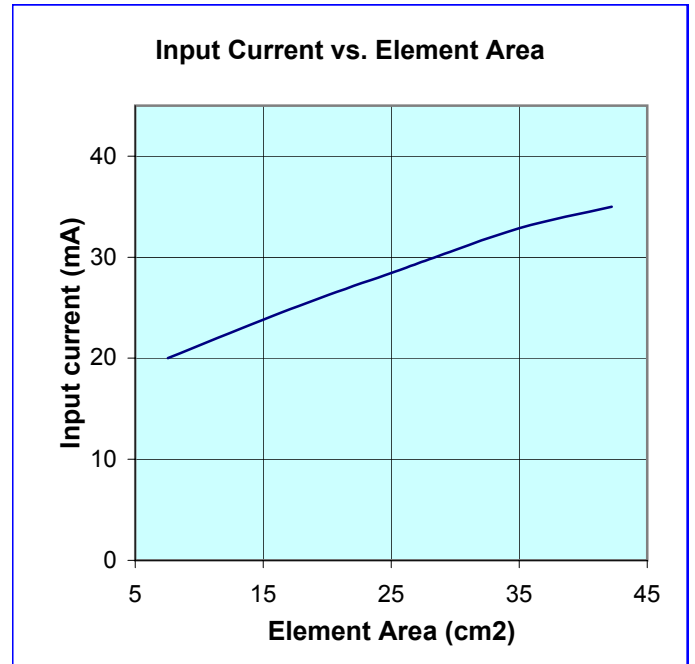
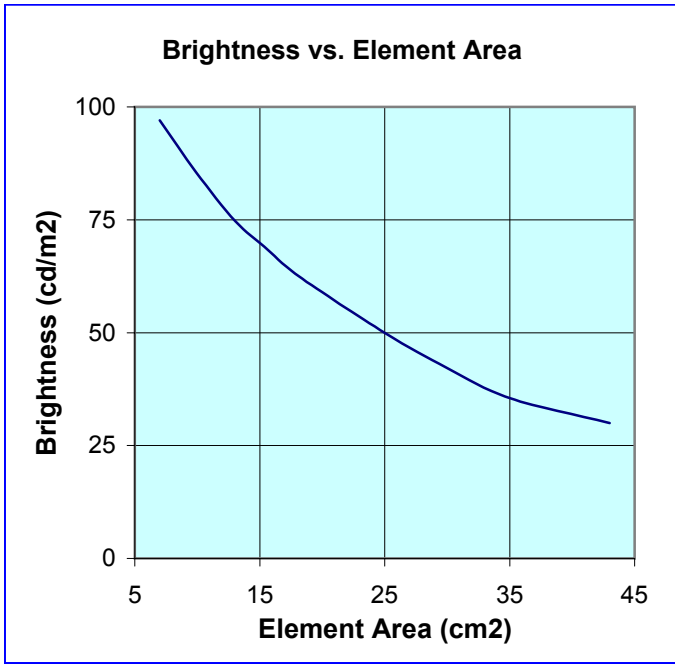

LOAD CHARACTERISTICS DATA

INVERTER: NDL-203

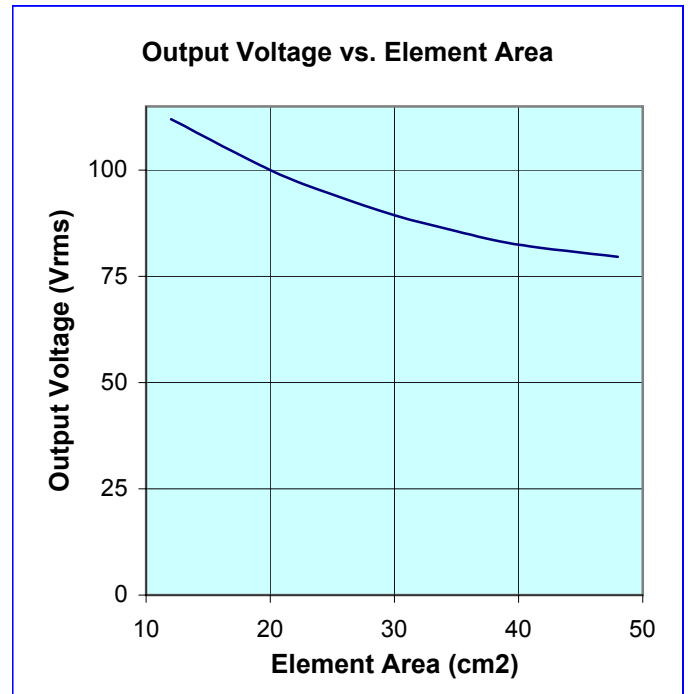
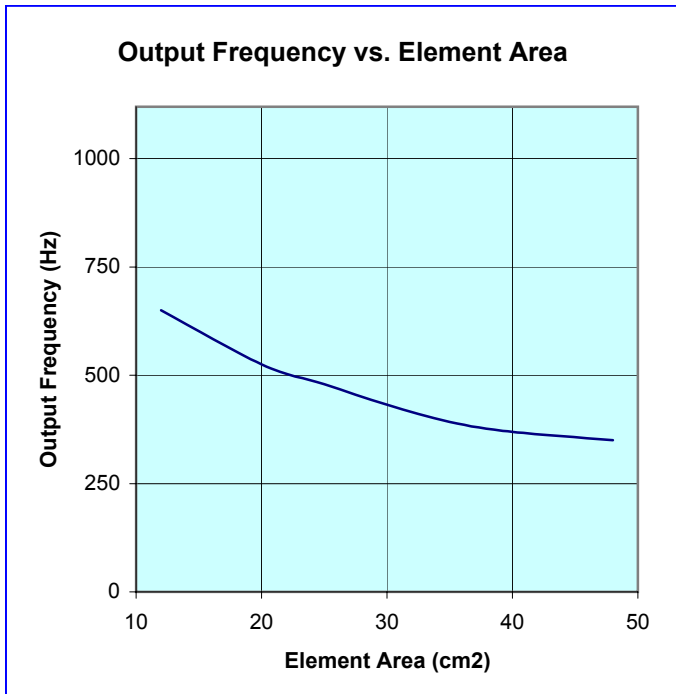
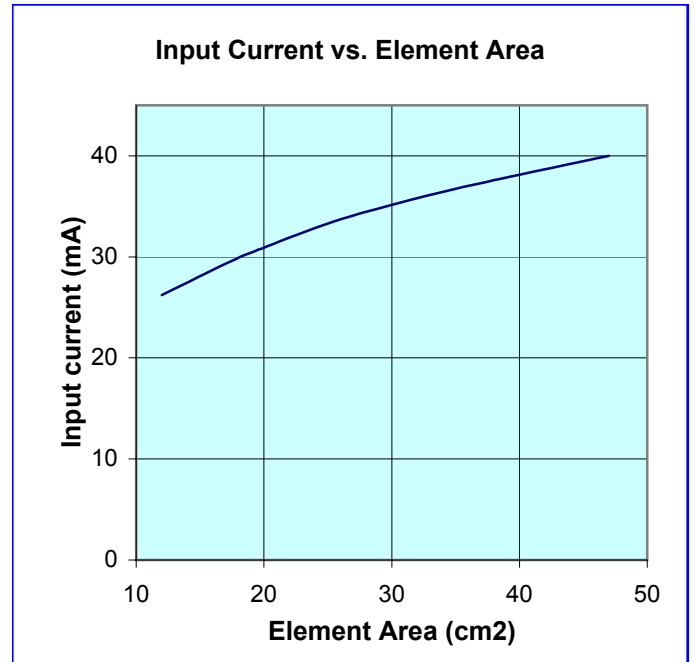
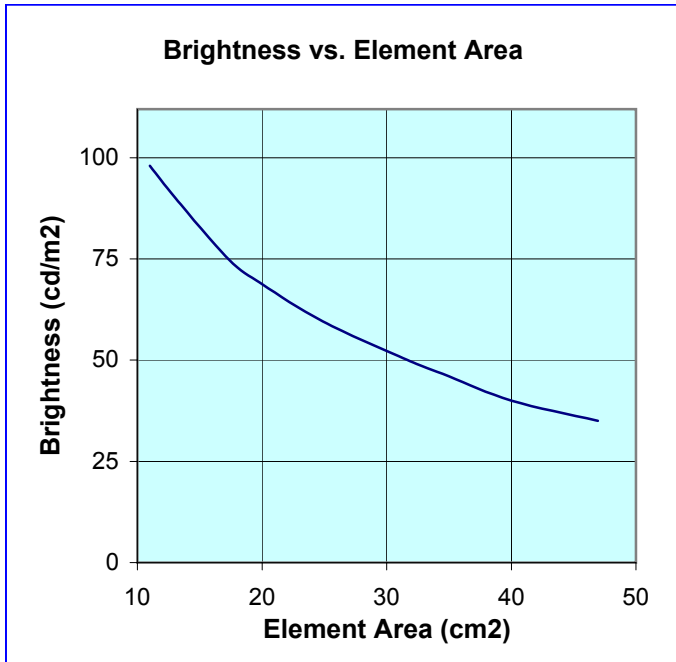

LOAD CHARACTERISTICS DATA

INVERTER: NDL-204

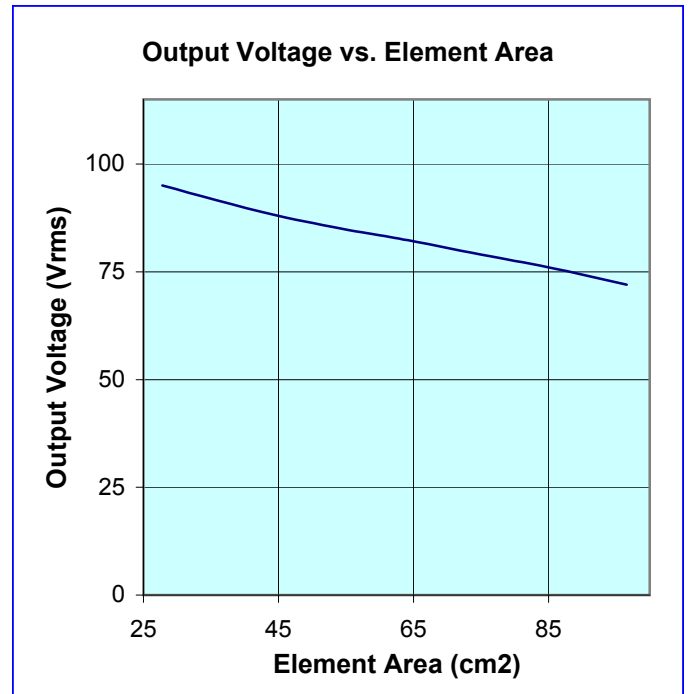
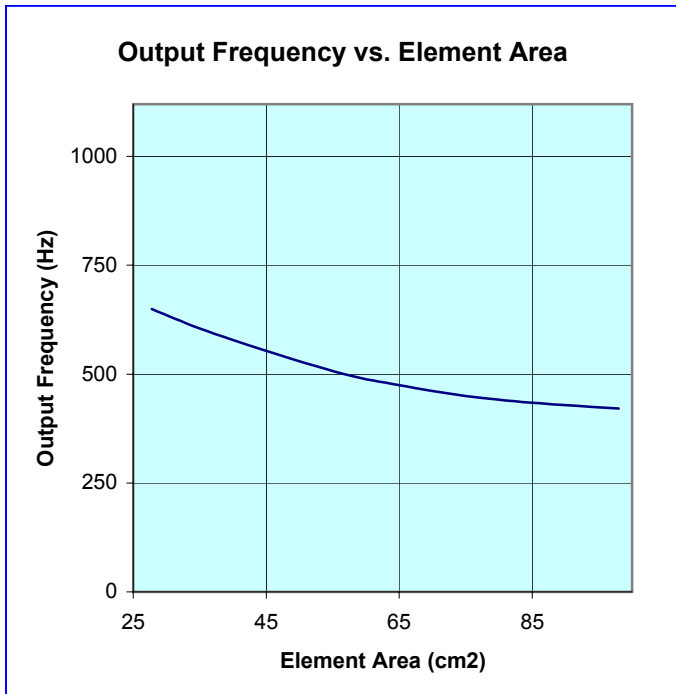
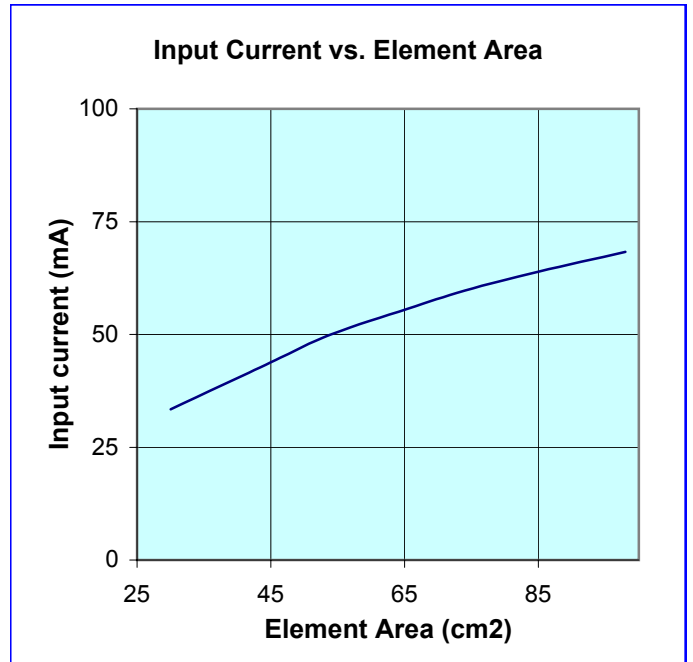
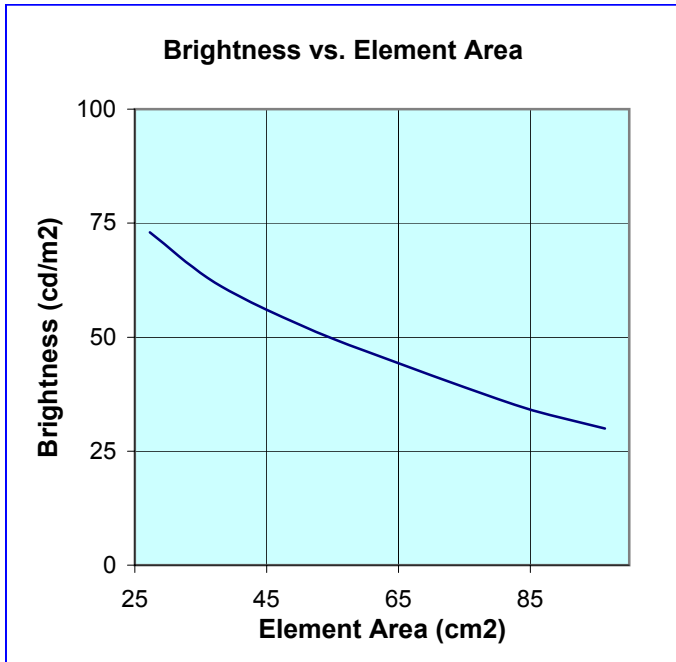

LOAD CHARACTERISTICS DATA

INVERTER: NDL-205

