

**Chip Monolithic Ceramic Capacitor meet AEC-Q200 for Infotainment
GRT188C81E105ME13_ (0603, X6S, 1uF, DC25V)**

_ : packaging code

Reference Sheet

1.Scope

This product specification is applied to Chip Monolithic Ceramic Capacitor used for Car Multimedia, Car Interior, Car Comfort application and General Electronic equipment.

Please contact us when using this product for any other applications than described in the above.

Do not use these products in applications critical to passenger safety and car driving function (e.g. ABS, AIRBAG, etc.).

2.MURATA Part NO. System

(Ex.)	GRT	18	8	C8	1E	105	M	E13	D
	(1)L/W Dimensions	(2)T Dimensions	(3)Temperature Characteristics	(4)Rated Voltage	(5)Nominal Capacitance	(6)Capacitance Tolerance	(7)Murata's Control Code	(8)Packaging Code	

3. Type & Dimensions



(Unit:mm)

(1)-1 L	(1)-2 W	(2) T	e	g
1.6±0.1	0.8±0.1	0.8±0.1	0.2 to 0.5	0.5 min.

4.Rated value

(3) Temperature Characteristics (Public STD Code):X6S(EIA)		(4) Rated Voltage	(5) Nominal Capacitance	(6) Capacitance Tolerance	Specifications and Test Methods (Operating Temp. Range)
Temp. coeff or Cap. Change	Temp. Range (Ref.Temp.)				
-22 to 22 %	-55 to 105 °C (25 °C)	DC 25 V	1 uF	±20 %	-55 to 105 °C

5.Package

mark	(8) Packaging	Packaging Unit
D	φ180mm Reel PAPER W8P4	4000 pcs./Reel
J	φ330mm Reel PAPER W8P4	10000 pcs./Reel

Product specifications in this catalog are as of Apr.17,2015,and are subject to change or obsolescence without notice.
Please consult the approval sheet before ordering.
Please read rating and !Cautions first.

No	AEC-Q200 Test Item	Specifications.	AEC-Q200 Test Method														
1	Pre-and Post-Stress Electrical Test		-														
2	High Temperature Exposure (Storage)	The measured and observed characteristics should satisfy the specifications in the following table.	Set the capacitor for 1000±12 hours at maximum operating temperature ±3°C. Set for 24±2 hours at room temperature, then measure.														
		Appearance		No marking defects													
		Capacitance Change		R6, C8: Within ±12.5%													
		Dissipation Factor		R6, C8: 0.2 max.													
		Insulation Resistance		25Ω·F min.													
3	Temperature Cycling	The measured and observed characteristics should satisfy the specifications in the following table.	Fix the capacitor to the supporting jig in the same manner and under the same conditions as (18). Perform the 1000 cycles test according to the four heat treatments in the following table. Set for 24±2 hours at room temperature, then measure.														
		Appearance		No marking defects													
		Capacitance Change		R6, C8: Within ±7.5%													
		Dissipation Factor		R6, C8: 0.2 max.													
		Insulation Resistance		50Ω·F min.													
		<table border="1"> <thead> <tr> <th>Step</th> <th>1</th> <th>2</th> <th>3</th> <th>4</th> </tr> </thead> <tbody> <tr> <td>Temp. (°C)</td> <td>-55+0/-3</td> <td>Room Temp.</td> <td>85 +3/-0 (For R6) 105+3/-0 (For C8)</td> <td>Room Temp.</td> </tr> <tr> <td>Time (min.)</td> <td>15±3</td> <td>1</td> <td>15±3</td> <td>1</td> </tr> </tbody> </table>	Step	1	2	3	4	Temp. (°C)	-55+0/-3	Room Temp.	85 +3/-0 (For R6) 105+3/-0 (For C8)	Room Temp.	Time (min.)	15±3	1	15±3	1
Step	1	2	3	4													
Temp. (°C)	-55+0/-3	Room Temp.	85 +3/-0 (For R6) 105+3/-0 (For C8)	Room Temp.													
Time (min.)	15±3	1	15±3	1													
		<ul style="list-style-type: none"> Initial measurement for high dielectric constant type Perform a heat treatment at 150+0/-10 °C for one hour and then set for 24±2 hours at room temperature. Perform the initial measurement.															
4	Destructive Physical Analysis	No defects or abnormalities	Per EIA-469														
5	Biased Humidity	The measured and observed characteristics should satisfy the specifications in the following table.	Apply the rated voltage and 1.3+0.2/-0vdc (add 6.8kΩ resistor) at 85±3°C and 80 to 85% humidity for 1000±12 hours. Remove and set for 24±2 hours at room temperature, then measure. The charge/discharge current is less than 50mA. •Measurement after test for high dielectric constant type Perform a heat treatment at 150+0/-10°C for one hour and then let sit for 24±2 hours at room temperature, then measure.														
		Appearance		No marking defects													
		Capacitance Change		R6,C8: Within ±12.5%													
		Dissipation Factor		R6,C8: 0.2 max													
		Insulation Resistance		5Ω·F min.													

No	AEC-Q200 Test Item	Specifications.	AEC-Q200 Test Method	
6	Operational Life	The measured and observed characteristics should satisfy the specifications in the following table.	Apply 100% of the rated voltage for 1000±12 hours at maximum operating temperature ±3°C. Set for 24±2 hours at room temperature, then measure. The charge/discharge current is less than 50mA. •Initial measurement for high dielectric constant type Perform a heat treatment at 150+0/-10°C for one hour and then set for 24±2 hours at room temperature. Perform the initial measurement. •Measurement after test for high dielectric constant type Perform a heat treatment at 150+0/-10°C for one hour and then let sit for 24±2 hours at room temperature, then measure.	
	Appearance	No marking defects		
	Capacitance Change	R6,C8: Within ±12.5%		
	Dissipation Factor	R6,C8: 0.2max		
	Insulation Resistance	50Ω · F min.		
7	External Visual	No defects or abnormalities	Visual inspection	
8	Physical Dimension	Within the specified dimensions	Using calipers	
9	Resistance to Solvents	Appearance	Per MIL-STD-202 Method 215 Solvent 1 : 1 part (by volume) of isopropyl alcohol 3 parts (by volume) of mineral spirits Solvent 2 : Terpene defluxer Solvent 3 : 42 parts (by volume) of water 1 part (by volume) of propylene glycol monomethyl ether 1 part (by volume) of monoethanolamine	
		Capacitance Change		Within the specified tolerance
		Dissipation Factor		R6,C8: 0.125max
		Insulation Resistance		50Ω · F min.
10	Mechanical Shock	Appearance	Three shocks in each direction should be applied along 3 mutually perpendicular axes of the test specimen (18 shocks). The specified test pulse should be Half-sine and should have a duration :0.5ms, peak value:1500g and velocity change: 4.7m/s.	
		Capacitance Change		Within the specified tolerance
		Dissipation Factor		R6,C8: 0.125max
		Insulation Resistance		50Ω · F min.
11	Vibration	Appearance	Solder the capacitor to the test jig (glass epoxy board) in the same manner and under the same conditions as (18). The capacitor should be subjected to a simple harmonic motion having a total amplitude of 1.5mm, the frequency being varied uniformly between the approximate limits of 10 and 2000Hz. The frequency range, from 10 to 2000Hz and return to 10Hz, should be traversed in approximately 20 minutes. This motion should be applied for 12 items in each 3 mutually perpendicular directions (total of 36 times).	
		Capacitance Change		Within the specified tolerance
		Dissipation Factor		R6,C8: 0.125max
		Insulation Resistance		50Ω · F min.
12	Resistance to Soldering Heat	The measured and observed characteristics should satisfy the specifications in the following table.	Immerse the capacitor in a eutectic solder solution at 260±5°C for 10±1 seconds. Set at room temperature for 24±2 hours, then measure. •Initial measurement for high dielectric constant type Perform a heat treatment at 150+0/-10 °C for one hour and then set for 24±2 hours at room temperature. Perform the initial measurement.	
		Appearance		No marking defects
		Capacitance Change		Within the specified tolerance
		Dissipation Factor		R6,C8: 0.125max
	Insulation Resistance	50Ω · F min.		

No	AEC-Q200 Test Item	Specifications.	AEC-Q200 Test Method											
13	Thermal Shock	The measured and observed characteristics shall satisfy the specifications in the following table.	Fix the capacitor to the supporting jig in the same manner and under the same conditions as (18). Perform the 300 cycles according to the two heat treatments listed in the following table (Maximum transfer time is 20 seconds). Set for 24±2 hours at room temperature, then measure. <table border="1" style="margin: 10px auto;"> <thead> <tr> <th>Step</th> <th>1</th> <th>2</th> </tr> </thead> <tbody> <tr> <td>Temp. (°C)</td> <td>-55+0/-3</td> <td>105+3/-0 (For C8) 85+3/-0 (For R6)</td> </tr> <tr> <td>Time (min.)</td> <td>15±3</td> <td>15±3</td> </tr> </tbody> </table> *Initial measurement for high dielectric constant type Perform a heat treatment at 150+0/-10 for one hour and then set for 24±2 hours at room temperature. Perform the initial measurement.	Step	1	2	Temp. (°C)	-55+0/-3	105+3/-0 (For C8) 85+3/-0 (For R6)	Time (min.)	15±3	15±3		
	Step	1		2										
	Temp. (°C)	-55+0/-3		105+3/-0 (For C8) 85+3/-0 (For R6)										
	Time (min.)	15±3		15±3										
Appearance	No marking defects													
Capacitance Change	R6,C8: Within ±10.0%													
14	ESD	Appearance	No marking defects											
		Capacitance Change	Within the specified tolerance											
		Dissipation Factor	R6,C8: 0.125max											
		Insulation Resistance	50Ω ·F min.											
			Per AEC-Q200-002 Voltage setting level : 2kV											
15	Solderability	95% of the terminations is to be soldered evenly and continuously.	(a) Preheat at 155°C for 4 hours. After preheating, immerse the capacitor in a solution of ethanol(JIS-K-8101) and rosin (JIS-K-5902) (25% rosin in weight proportion). Immerse in eutectic solder solution for 5+0/-0.5 seconds at 235±5°C.											
			(b) Should be placed into steam aging for 8 hours±15 minutes. After preheating, immerse the capacitor in a solution of ethanol(JIS-K-8101) and rosin (JIS-K-5902) (25% rosin in weight proportion). Immerse in eutectic solder solution for 5+0/-0.5 seconds at 235±5°C.											
			(c) Should be placed into steam aging for 8 hours±15 minutes. After preheating, immerse the capacitor in a solution of ethanol(JIS-K-8101) and rosin (JIS-K-5902) (25% rosin in weight proportion). Immerse in eutectic solder solution for 120±5 seconds at 260±5°C.											
16	Electrical Characterization	Appearance	No defects or abnormalities											
		Capacitance Change	Within the specified tolerance											
		Dissipation Factor	R6,C8 :0.125max											
				Visual inspection.										
				The capacitance/Q/D.F. should be measured at 25°C at the frequency and voltage shown in the table.										
				<table border="1" style="margin: 10px auto;"> <thead> <tr> <th>Char. \ Item</th> <th>R6,C8 6.3V max. (C≤10μF)</th> <th>R6,C8 10V min. (C≤10μF)</th> <th>R6,C8 (10μF< C)</th> </tr> </thead> <tbody> <tr> <td>Frequency</td> <td>1±0.1kHz</td> <td>1±0.1kHz</td> <td>120±24Hz</td> </tr> <tr> <td>Voltage</td> <td>0.5±0.1Vrms</td> <td>1±0.2Vrms</td> <td>0.5±0.1Vrms</td> </tr> </tbody> </table>	Char. \ Item	R6,C8 6.3V max. (C≤10μF)	R6,C8 10V min. (C≤10μF)	R6,C8 (10μF< C)	Frequency	1±0.1kHz	1±0.1kHz	120±24Hz	Voltage	0.5±0.1Vrms
Char. \ Item	R6,C8 6.3V max. (C≤10μF)	R6,C8 10V min. (C≤10μF)	R6,C8 (10μF< C)											
Frequency	1±0.1kHz	1±0.1kHz	120±24Hz											
Voltage	0.5±0.1Vrms	1±0.2Vrms	0.5±0.1Vrms											
Insulation Resistance 25°C	50Ω ·F min.	The insulation resistance should be measured with a DC voltage not exceeding the rated voltage at 25°C and maximum operating temperature** within 1 minute of charging.												
Insulation Resistance 85°C(For R6) 105°C(For C8)	50 ·F min.	**85+3/-0°C(For R6), 105+3/-0°C(For C8)												
Dielectric Strength	No failure	No failure should be observed when 250% of the rated voltage is applied between the terminations for 1 to 5 seconds, provided the charge/ discharge current is less than 50mA.												

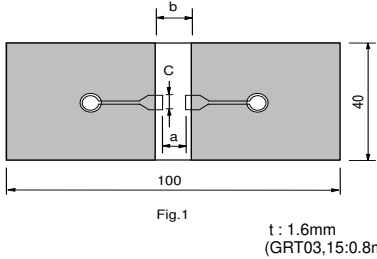
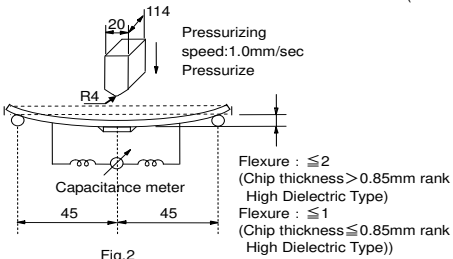
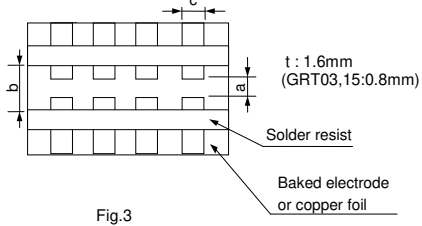
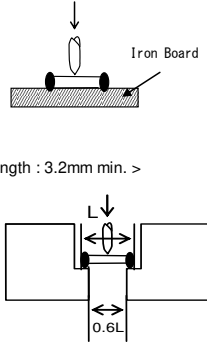
No	AEC-Q200 Test Item	Specifications.	AEC-Q200 Test Method																								
17	Board Flex	Appearance	<p>Solder the capacitor on the test jig (glass epoxy board) shown in Fig.1 using a eutectic solder. Then apply a force in the direction shown in Fig 2 for 5±1sec. The soldering should be done by the reflow method and should be conducted with care so that the soldering is uniform and free of defects such as heat shock.</p> <table border="1"> <thead> <tr> <th>Type</th> <th>a</th> <th>b</th> <th>c</th> </tr> </thead> <tbody> <tr> <td>GRT03</td> <td>0.3</td> <td>0.9</td> <td>0.3</td> </tr> <tr> <td>GRT15</td> <td>0.5</td> <td>1.5</td> <td>0.6</td> </tr> <tr> <td>GRT18</td> <td>0.6</td> <td>2.2</td> <td>0.9</td> </tr> <tr> <td>GRT21</td> <td>0.8</td> <td>3.0</td> <td>1.3</td> </tr> <tr> <td>GRT31</td> <td>2.0</td> <td>4.4</td> <td>1.7</td> </tr> </tbody> </table> <p style="text-align: right;">(in mm)</p>  <p style="text-align: center;">Fig.1 t : 1.6mm (GRT03,15:0.8mm)</p>  <p style="text-align: center;">Fig.2</p>	Type	a	b	c	GRT03	0.3	0.9	0.3	GRT15	0.5	1.5	0.6	GRT18	0.6	2.2	0.9	GRT21	0.8	3.0	1.3	GRT31	2.0	4.4	1.7
	Type	a		b	c																						
	GRT03	0.3		0.9	0.3																						
	GRT15	0.5		1.5	0.6																						
GRT18	0.6	2.2	0.9																								
GRT21	0.8	3.0	1.3																								
GRT31	2.0	4.4	1.7																								
Capacitance Change	Within specified tolerance																										
Dissipation Factor	R6,C8: 0.125max																										
Insulation Resistance	50Ω · F min.																										
18	Terminal Strength	Appearance	<p>Solder the capacitor to the test jig (glass epoxy board) shown in Fig.3 using a eutectic solder. Then apply *18N force in parallel with the test jig for 60sec. The soldering should be done either with an iron or using the reflow method and should be conducted with care so that the soldering is uniform and free of defects such as heat shock</p> <p style="text-align: center;">*2N(GRT03,15)</p> <table border="1"> <thead> <tr> <th>Type</th> <th>a</th> <th>b</th> <th>c</th> </tr> </thead> <tbody> <tr> <td>GRT03</td> <td>0.3</td> <td>0.9</td> <td>0.3</td> </tr> <tr> <td>GRT15</td> <td>0.4</td> <td>1.5</td> <td>0.5</td> </tr> <tr> <td>GRT18</td> <td>1.0</td> <td>3.0</td> <td>1.2</td> </tr> <tr> <td>GRT21</td> <td>1.2</td> <td>4.0</td> <td>1.65</td> </tr> <tr> <td>GRT31</td> <td>2.2</td> <td>5.0</td> <td>2.0</td> </tr> </tbody> </table> <p style="text-align: right;">(in mm)</p>  <p style="text-align: center;">Fig.3</p>	Type	a	b	c	GRT03	0.3	0.9	0.3	GRT15	0.4	1.5	0.5	GRT18	1.0	3.0	1.2	GRT21	1.2	4.0	1.65	GRT31	2.2	5.0	2.0
	Type	a		b	c																						
	GRT03	0.3		0.9	0.3																						
	GRT15	0.4		1.5	0.5																						
GRT18	1.0	3.0	1.2																								
GRT21	1.2	4.0	1.65																								
GRT31	2.2	5.0	2.0																								
Capacitance Change	Within specified tolerance																										
Dissipation Factor	R6,C8: 0.125max																										
Insulation Resistance	50Ω · F min.																										
19	Beam Load Test	Destruction value should be exceed following one.	<p>Place the capacitor in the beam load fixture as Fig. 4. Apply a force.</p> <p>< Chip Length : 2.5mm max. ></p>  <p style="text-align: center;">Fig.4</p> <p>Speed supplied the Stress Load : *0.5mm / sec. *GRT03: 0.1mm/sec.</p>																								
		<p>< Chip L dimension : 2.5mm max. ></p> <p style="margin-left: 40px;">Chip thickness > 0.5mm rank : 20N Chip thickness ≤ 0.5mm rank : 8N</p> <p>< Chip L dimension : 3.2mm min. ></p> <p style="margin-left: 40px;">Chip thickness < 1.25mm rank : 15N Chip thickness ≥ 1.25mm rank : 54.5N</p>																									

No	AEC-Q200 Test Item		Specifications.	AEC-Q200 Test Method												
20	Capacitance Temperature Characteristics	Capacitance Change	R6 : Within $\pm 15\%$ (-55°C to +85°C) C8 : Within $\pm 22\%$ (-55°C to +105°C)	The capacitance change should be measured after 5 min. at each specified temperature stage. The ranges of capacitance change compared with the above 25°C value over the temperature ranges shown in the table should be within the specified ranges. ·Initial measurement for high dielectric constant type Perform a heat treatment at 150+0/-10°C for one hour and then set for 24±2 hours at room temperature. Perform the initial measurement. <table border="1" data-bbox="946 577 1289 741"> <thead> <tr> <th>Step</th> <th>Temperature.(°C)</th> </tr> </thead> <tbody> <tr> <td>1</td> <td>25±2</td> </tr> <tr> <td>2</td> <td>-55±3</td> </tr> <tr> <td>3</td> <td>25±2</td> </tr> <tr> <td>4</td> <td>85±3 (for R6) , 105±3 (for C8)</td> </tr> <tr> <td>5</td> <td>25±2</td> </tr> </tbody> </table>	Step	Temperature.(°C)	1	25±2	2	-55±3	3	25±2	4	85±3 (for R6) , 105±3 (for C8)	5	25±2
Step	Temperature.(°C)															
1	25±2															
2	-55±3															
3	25±2															
4	85±3 (for R6) , 105±3 (for C8)															
5	25±2															

1. Tape Carrier Packaging(Packaging Code:D/E/F/L/J/K)

1.1 Minimum Quantity(pcs./reel)

Type	φ180mm reel		φ330mm reel	
	Paper Tape	Plastic Tape	Paper Tape	Plastic Tape
	Code:D/E	Code:L	Code:J/ F	Code:K
GRT03	15000		50000	
GRT15	5(Dimensions Tolerance:±0.05)	10000	50000	
	5(Dimensions Tolerance:±0.1min.)	10000	40000	
GRT18	4000		10000	
GRT21	6	4000	10000	
	9	4000	10000	
	B		3000	10000
GRT31	6	4000	10000	
	9	4000	10000	
	M		3000	10000
	C		2000	6000
GRT32	N		2000	8000
	D/E		1000	4000

1.2 Dimensions of Tape

(1)GRT03/15(Paper Tape)

(in mm)

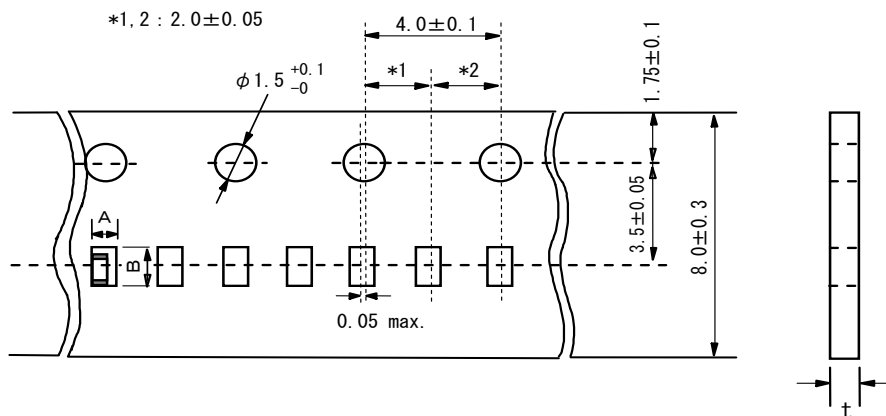

Type	LW Dimensions Tolerance(Chip)	A *3	B *3	t
GRT03	±0.03	0.37	0.67	0.5 max.
	±0.05	0.39	0.69	
GRT15	±0.05	0.65	1.15	0.8 max.
	±0.1	0.70	1.20	
	±0.2	0.75	1.35	

*3 Nominal value

(2)GRT18/21/31/32(Paper Tape)

(in mm)

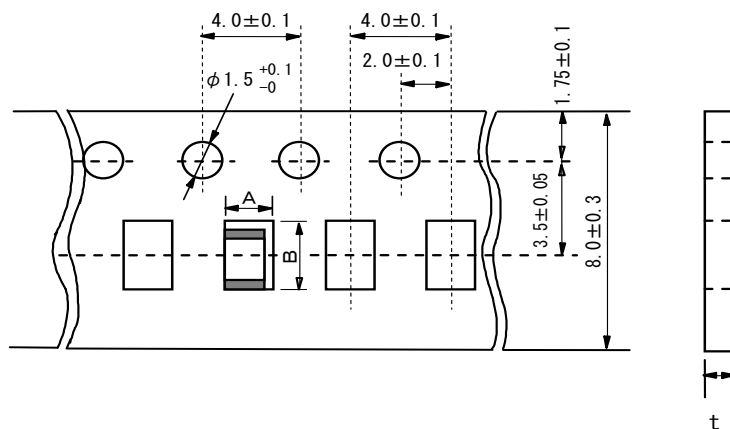

Type	LW Dimensions Tolerance(Chip)	T Dimensions (Chip)	A	B	t
GRT18	8	±0.15 within 0.8±0.1 0.8±0.15	1.05±0.10	1.85±0.10	1.1 max.
		±0.2	1.10±0.10	2.00±0.10	
GRT21	6	±0.1 0.6±0.1 0.6+0/-0.15	1.55±0.15	2.30±0.15	
	9	±0.15 within 0.85±0.1 0.85+0/-0.2			
GRT31	6	±0.15 0.6±0.1	2.00±0.20	3.60±0.20	
	9	±0.2 within 0.85±0.1			

(3)GRT21/31/32(Plastic Tape)

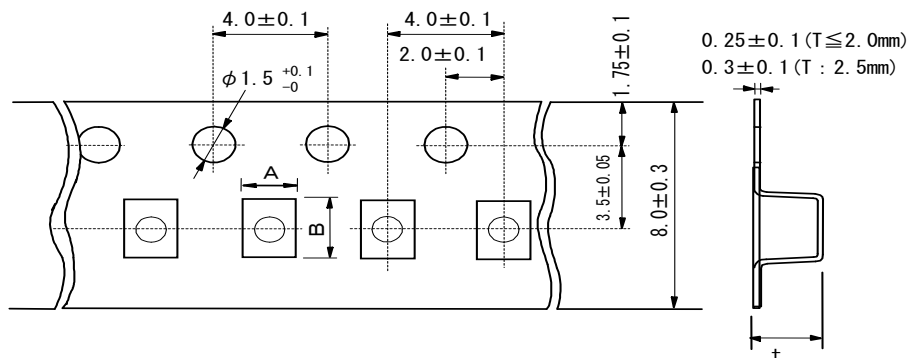

Type	LW Dimensions Tolerance(Chip)	T Dimensions (Chip)	A	B	t	
GRT21	B	±0.1	1.25±0.1	1.45±0.20	2.25±0.20	1.7 max.
		±0.15	1.25±0.15	1.50±0.20	2.30±0.20	2.0 max.
		±0.2	1.25±0.2			
GRT31	M	±0.15 ±0.2	1.90±0.20	3.50±0.20	1.7 max.	
	C	±0.2			2.5 max.	
GRT32	N D E	L:±0.3 W:±0.2	1.35±0.15	2.80±0.20	3.50±0.20	2.5 max.
			2.0±0.2			3.0 max.
			2.5±0.2			3.7 max.

Fig.1 Package Chips

(in mm)

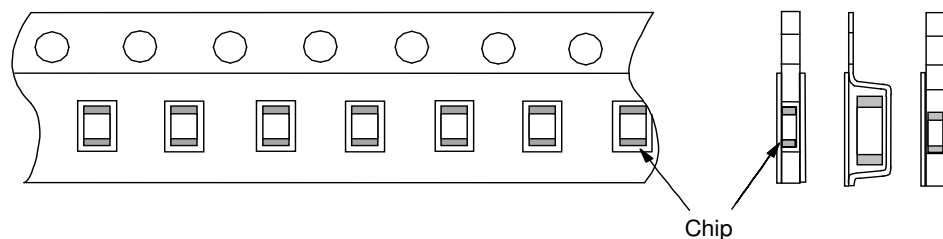

Fig.2 Dimensions of Reel

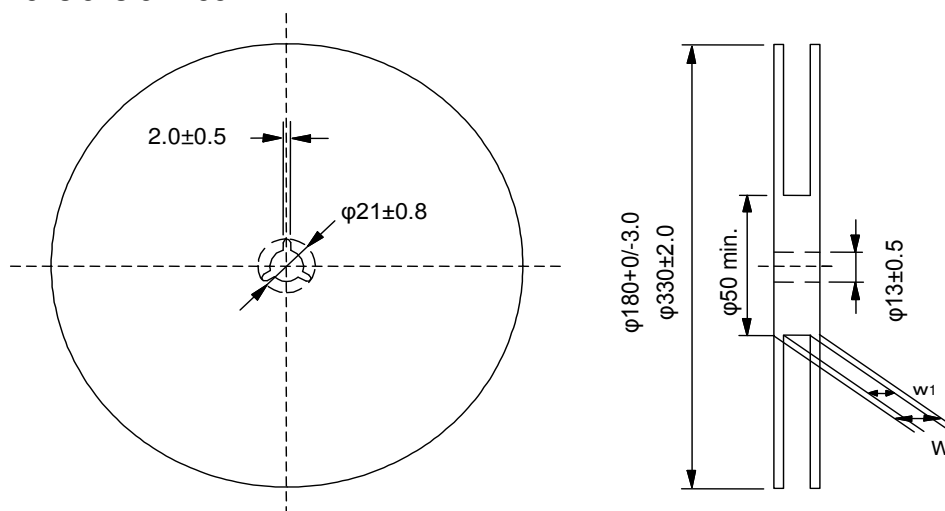
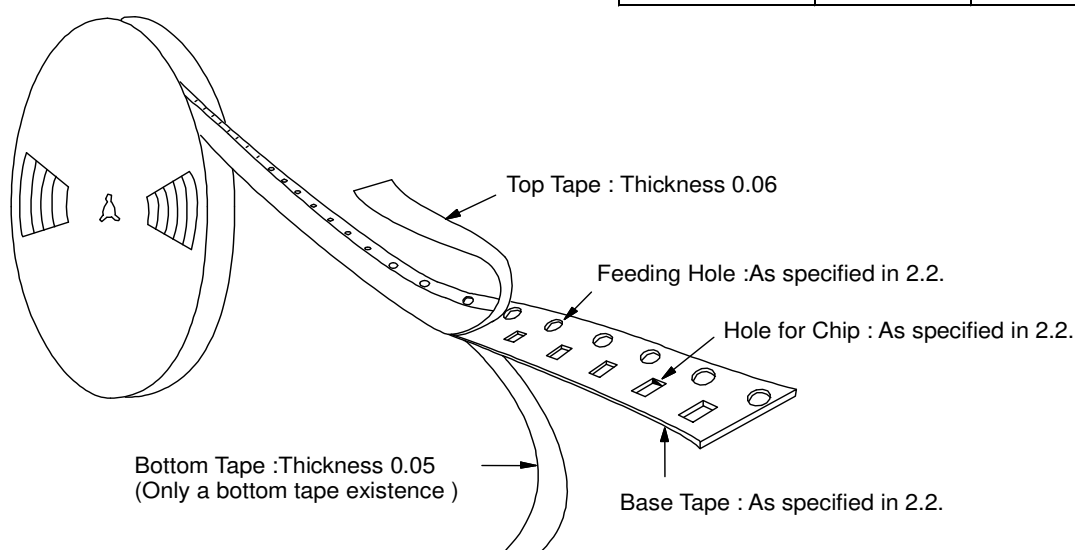

Fig.3 Taping Diagram

	W	w ₁
GRT32 max.	16.5 max.	10±1.5



1.3 Tapes for capacitors are wound clockwise shown in Fig.3.
(The sprocket holes are to the right as the tape is pulled toward the user.)

1.4 Part of the leader and part of the vacant section are attached as follows.

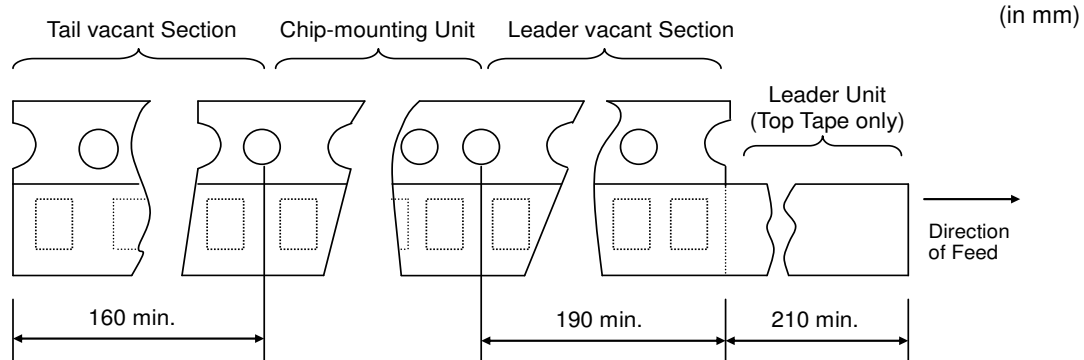

1.5 Accumulate pitch : 10 of sprocket holes pitch = 40 ± 0.3 mm

1.6 Chip in the tape is enclosed by top tape and bottom tape as shown in Fig.1.

1.7 The top tape and base tape are not attached at the end of the tape for a minimum of 5 pitches.

1.8 There are no jointing for top tape and bottom tape.

1.9 There are no fuzz in the cavity.

1.10 Break down force of top tape : 5N min.

Break down force of bottom tape : 5N min. (Only a bottom tape existence)

1.11 Reel is made by resin and appeaser and dimension is shown in Fig 1. There are possibly to change the material and dimension due to some impairment.

1.12 Peeling off force : 0.1N to 0.6N* in the direction as shown below.

* GRT03:0.05N to 0.5N

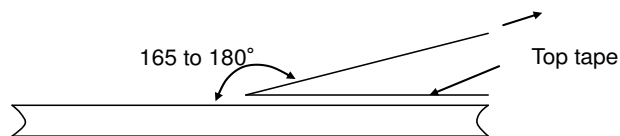

1.13 Label that show the customer parts number, our parts number, our company name, inspection number and quantity, will be put in outside of reel.

■ Limitation of Applications

Please contact us before using our products for the applications listed below which require especially high reliability for the prevention of defects which might directly cause damage to the third party's life, body or property.

- ① Aircraft equipment ② Aerospace equipment ③ Undersea equipment ④ Power plant control equipment
- ⑤ Medical equipment ⑥ Transportation equipment(vehicles, trains, ships, etc.) ⑦ Traffic signal equipment
- ⑧ Disaster prevention / crime prevention equipment ⑨ Data-processing equipment
- ⑩ Application of similar complexity and/or reliability requirements to the applications listed in the above.

This series is designed for use in Car Multimedia, Car Interior, Car Comfort application and General Electronic equipment. It shall not be used in applications critical to passenger safety and car driving function(e.g. ABS, AIRBAG, etc.).

■ Storage and Operation condition

1. The performance of chip monolithic ceramic capacitors may be affected by the storage conditions.

1-1. Store the capacitors in the following conditions: Room Temperature of +5°C to +40°C and a Relative Humidity of 20% to 70%.

- (1) Sunlight, dust, rapid temperature changes, corrosive gas atmosphere or high temperature and humidity conditions during storage may affect solderability and packaging performance. Therefore, please maintain the storage temperature and humidity. Use the product within six months, as prolonged storage may cause oxidation of the electrodes.
- (2) Please confirm solderability before using after six months. Store the capacitors without opening the original bag. Even if the storage period is short, do not exceed the specified atmospheric conditions.

1-2. Corrosive gas can react with the termination (external) electrodes or lead wires of capacitors, and result in poor solderability. Do not store the capacitors in an atmosphere consisting of corrosive gas (e.g., hydrogen sulfide, sulfur dioxide, chlorine, ammonia gas etc.).

1-3. Due to moisture condensation caused by rapid humidity changes, or the photochemical change caused by direct sunlight on the terminal electrodes and/or the resin/epoxy coatings, the solderability and electrical performance may deteriorate. Do not store capacitors under direct sunlight or in high humidity conditions

■ Rating

1. Temperature Dependent Characteristics

1. The electrical characteristics of the capacitor can change with temperature.

1-1. For capacitors having larger temperature dependency, the capacitance may change with temperature changes. The following actions are recommended in order to ensure suitable capacitance values.

- (1) Select a suitable capacitance for the operating temperature range.
- (2) The capacitance may change within the rated temperature.

When you use a high dielectric constant type capacitors in a circuit that needs a tight (narrow) capacitance tolerance (e.g., a time-constant circuit), please carefully consider the temperature characteristics, and carefully confirm the various characteristics in actual use conditions and the actual system.

[Example of Temperature Characteristics R7]
Sample: 0.1μF, Rated Voltage 50VDC



[Example of Temperature Characteristics R6]
Sample: 22μF, Rated Voltage 4VDC

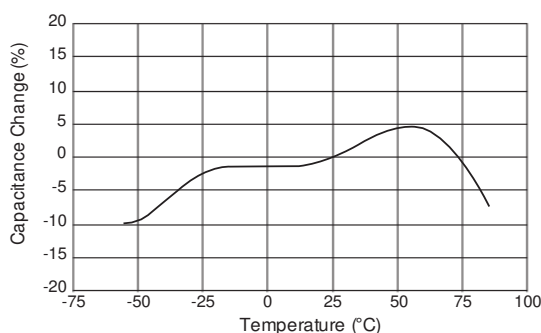

2.Measurement of Capacitance

1. Measure capacitance with the voltage and frequency specified in the product specifications.
 - 1-1. The output voltage of the measuring equipment may decrease occasionally when capacitance is high. Please confirm whether a prescribed measured voltage is impressed to the capacitor.
 - 1-2. The capacitance values of high dielectric constant type capacitors change depending on the AC voltage applied. Please consider the AC voltage characteristics when selecting a capacitor to be used in a AC circuit.

3.Applied Voltage

1. Do not apply a voltage to the capacitor that exceeds the rated voltage as called out in the specifications.
 - 1-1. Applied voltage between the terminals of a capacitor shall be less than or equal to the rated voltage.
 - (1) When AC voltage is superimposed on DC voltage, the zero-to-peak voltage shall not exceed the rated DC voltage. When AC voltage or pulse voltage is applied, the peak-to-peak voltage shall not exceed the rated DC voltage.
 - (2) Abnormal voltages (surge voltage, static electricity, pulse voltage, etc.) shall not exceed the rated DC voltage.

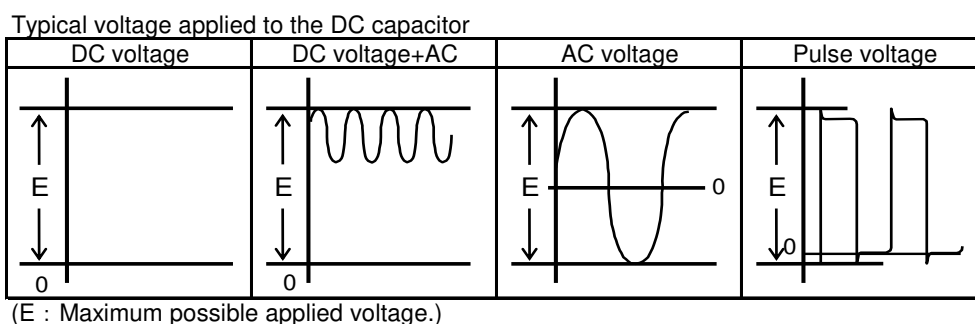

- 1-2. Influence of over voltage

Over voltage that is applied to the capacitor may result in an electrical short circuit caused by the breakdown of the internal dielectric layers .

The time duration until breakdown depends on the applied voltage and the ambient temperature.

4.Type of Applied Voltage and Self-heating Temperature

- 1.Confirm the operating conditions to make sure that nolarge current is flowing into the capacitor due to the continuous application of an AC voltage or pulse voltage.

When a DC rated voltage product is used in an AC voltage circuit or a pulse voltage circuit, the AC current or pulse current will flow into the capacitor; therefore check the self-heating condition.

Please confirm the surface temperature of the capacitor so that the temperature remains within the upper limits of the operating temperature, including the rise in temperature due to self-heating. When the capacitor is used with a high-frequency voltage or pulse voltage, heat may be generated by dielectric loss.

- <Applicable to Rated Voltage of less than 100VDC>
- 1-1. The load should be contained to the level such that when measuring at atmospheric temperature of 25°C, the product's self-heating remains below 20°C and the surface temperature of the capacitor in the actual circuit remains within the maximum operating temperature.

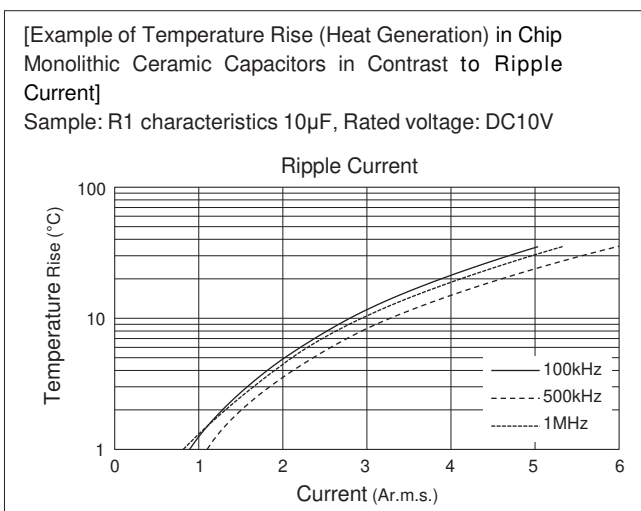

5. DC Voltage and AC Voltage Characteristic

1. The capacitance value of a high dielectric constant type capacitor changes depending on the DC voltage applied. Please consider the DC voltage characteristics when a capacitor is selected for use in a DC circuit.

1-1. The capacitance of ceramic capacitors may change sharply depending on the applied voltage. (See figure) Please confirm the following in order to secure the capacitance.

- (1) Determine whether the capacitance change caused by the applied voltage is within the allowed range .
- (2) In the DC voltage characteristics, the rate of capacitance change becomes larger as voltage increases, even if the applied voltage is below the rated voltage. When a high dielectric constant type capacitor is used in a circuit that requires a tight (narrow) capacitance tolerance (e.g., a time constant circuit), please carefully consider the voltage characteristics, and confirm the various characteristics in actual operating conditions in an actual system.

2. The capacitance values of high dielectric constant type capacitors changes depending on the AC voltage applied. Please consider the AC voltage characteristics when selecting a capacitor to be used in a AC circuit.

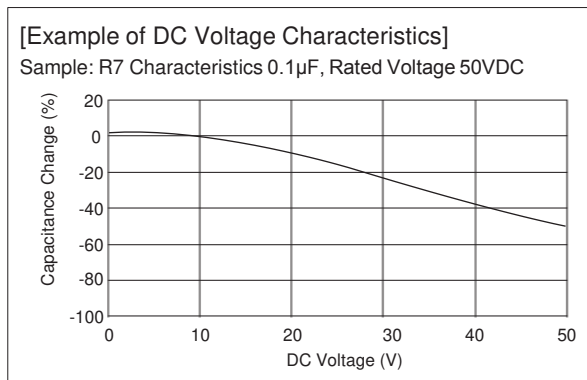

6. Capacitance Aging

1. The high dielectric constant type capacitors have the characteristic in which the capacitance value decreases with the passage of time. When you use a high dielectric constant type capacitors in a circuit that needs a tight (narrow) capacitance tolerance (e.g., a time-constant circuit), please carefully consider the characteristics of these capacitors, such as their aging, voltage, and temperature characteristics. In addition, check capacitors using your actual appliances at the intended environment and operating conditions.

[Example of Change Over Time (Aging characteristics)]

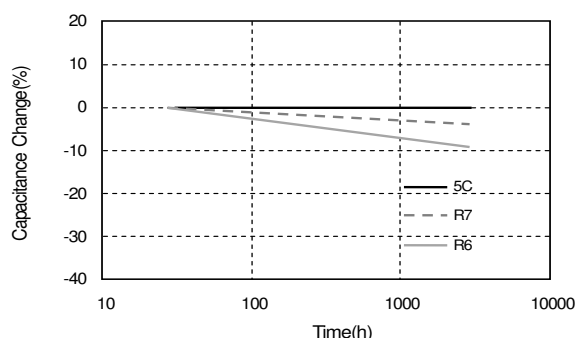

7.Vibration and Shock

1. Please confirm the kind of vibration and/or shock, its condition, and any generation of resonance. Please mount the capacitor so as not to generate resonance, and do not allow any impact on the terminals.

2. Mechanical shock due to being dropped may cause damage or a crack in the dielectric material of the capacitor. Do not use a fallen capacitor because the quality and reliability may be deteriorated.

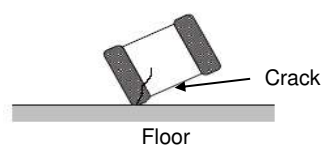

3. When printed circuit boards are piled up or handled, the corner of another printed circuit board should not be allowed to hit the capacitor in order to avoid a crack or other damage to the capacitor.

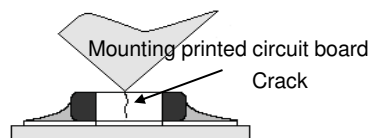

■ Soldering and Mounting

1. Mounting Position

1. Confirm the best mounting position and direction that minimizes the stress imposed on the capacitor during flexing or bending the printed circuit board.

1-1. Choose a mounting position that minimizes the stress imposed on the chip during flexing or bending of the board.

[Component Direction]

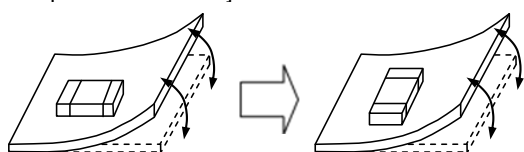

Locate chip horizontal to the direction in which stress acts.

[Chip Mounting Close to Board Separation Point]

It is effective to implement the following measures, to reduce stress in separating the board.

It is best to implement all of the following three measures; however, implement as many measures as possible to reduce stress.

Contents of Measures	Stress Level
(1) Turn the mounting direction of the component parallel to the board separation surface.	A > D
(2) Add slits in the board separation part.	A > B
(3) Keep the mounting position of the component away from the board separation surface.	A > C

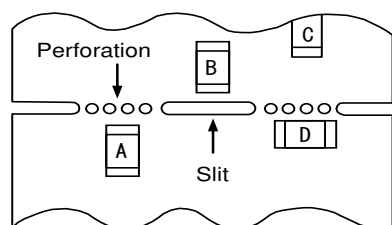

[Mounting Capacitors Near Screw Holes]

When a capacitor is mounted near a screw hole, it may be affected by the board deflection that occurs during the tightening of the screw. Mount the capacitor in a position as far away from the screw holes as possible.

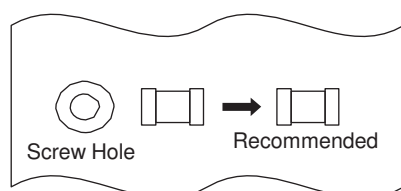

2. Information before Mounting

1. Do not re-use capacitors that were removed from the equipment.
2. Confirm capacitance characteristics under actual applied voltage.
3. Confirm the mechanical stress under actual process and equipment use.
4. Confirm the rated capacitance, rated voltage and other electrical characteristics before assembly.
5. Prior to use, confirm the solderability for the capacitors that were in long-term storage.
6. Prior to measuring capacitance, carry out a heat treatment for capacitors that were in long-term storage.
7. The use of Sn-Zn based solder will deteriorate the reliability of the MLCC.
Please contact our sales representative or product engineers on the use of Sn-Zn based solder in advance.

3. Maintenance of the Mounting (pick and place) Machine

1. Make sure that the following excessive forces are not applied to the capacitors.

1-1. In mounting the capacitors on the printed circuit board, any bending force against them shall be kept to prevent them from any bending damage or cracking. Please take into account the following precautions and recommendations for use in your process.

(1) Adjust the lowest position of the pickup nozzle so as not to bend the printed circuit board.

(2) Adjust the nozzle pressure within a static load of 1N to 3N during mounting.

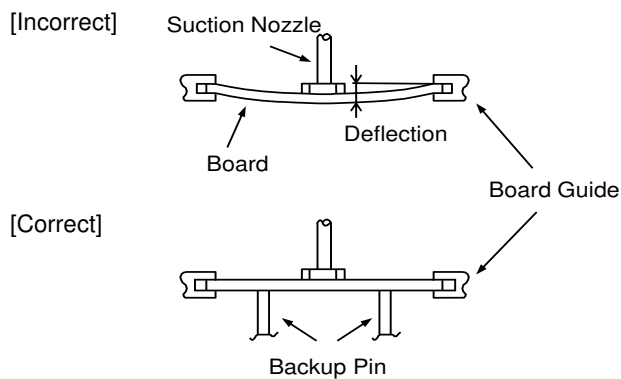

2. Dirt particles and dust accumulated between the suction nozzle and the cylinder inner wall prevent the nozzle from moving smoothly. This imposes greater force upon the chip during mounting, causing cracked chips. Also, the locating claw, when worn out, imposes uneven forces on the chip when positioning, causing cracked chips. The suction nozzle and the locating claw must be maintained, checked and replaced periodically.

4-1.Reflow Soldering

- When sudden heat is applied to the components, the mechanical strength of the components will decrease because a sudden temperature change causes deformation inside the components. In order to prevent mechanical damage to the components, preheating is required for both the components and the PCB. Preheating conditions are shown in table 1. It is required to keep the temperature differential between the solder and the components surface (ΔT) as small as possible.
- Solderability of tin plating termination chips might be deteriorated when a low temperature soldering profile where the peak solder temperature is below the melting point of tin is used. Please confirm the solderability of tin plated termination chips before use.
- When components are immersed in solvent after mounting, be sure to maintain the temperature difference (ΔT) between the component and the solvent within the range shown in the table 1.

Table 1

Part Number	Temperature Differential
GRT03/15/18/21/31	$\Delta T \leq 190^{\circ}\text{C}$
GRT32	$\Delta T \leq 130^{\circ}\text{C}$

Recommended Conditions

	Pb-Sn Solder		Lead Free Solder
	Reflow	Vapor Reflow	
Peak Temperature	230 to 250°C	230 to 240°C	240 to 260°C
Atmosphere	Air	Saturated vapor of inactive solvent	Air or N ₂

Pb-Sn Solder: Sn-37Pb

Lead Free Solder: Sn-3.0Ag-0.5Cu

4. Optimum Solder Amount for Reflow Soldering

- Overly thick application of solder paste results in a excessive solder fillet height. This makes the chip more susceptible to mechanical and thermal stress on the board and may cause the chips to crack.
- Too little solder paste results in a lack of adhesive strength on the outer electrode, which may result in chips breaking loose from the PCB.
- Make sure the solder has been applied smoothly to the end surface to a height of 0.2mm* min.

[Standard Conditions for Reflow Soldering]

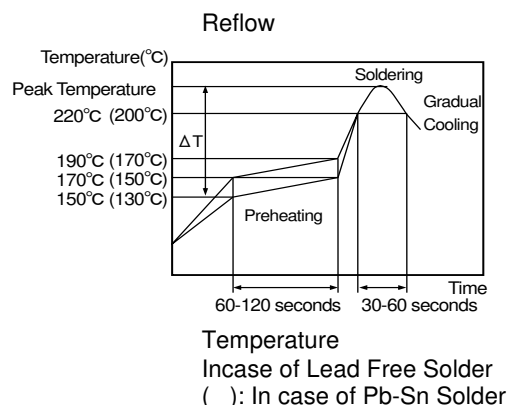

Vapor Reflow

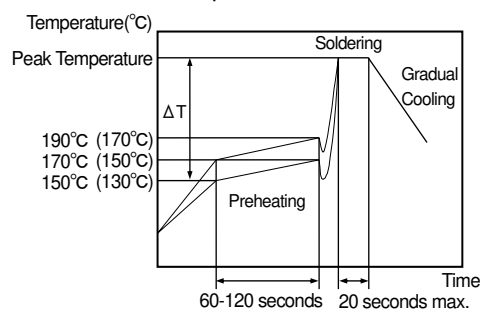

[Allowable Reflow Soldering Temperature and Time]

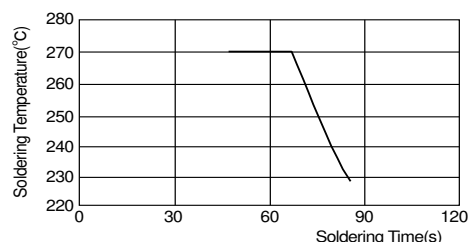

In the case of repeated soldering, the accumulated soldering time must be within the range shown above.

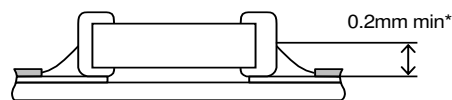

*GRT03: 1/3 of Chip Thickness min. in section

Inverting the PCB

Make sure not to impose any abnormal mechanical shocks to the PCB.

4-2.Flow Soldering

1. Do not apply flow soldering to chips not listed in Table 2.

Table 2

Part Number	Temperature Differential
GRT18/21/31	$\Delta T \leq 150^{\circ}\text{C}$

2. When sudden heat is applied to the components, the mechanical strength of the components will decrease because a sudden temperature change causes deformation inside the components. In order to prevent mechanical damage to the components, preheating is required for both of the components and the PCB. Preheating conditions are shown in table 2. It is required to keep the temperature differential between the solder and the components surface (ΔT) as low as possible.

3. Excessively long soldering time or high soldering temperature can result in leaching of the outer electrodes, causing poor adhesion or a reduction in capacitance value due to loss of contact between the electrodes and end termination.

4. When components are immersed in solvent after mounting, be sure to maintain the temperature differential (ΔT) between the component and solvent within the range shown in the table 2.

Recommended Conditions

	Pb-Sn Solder	Lead Free Solder
Preheating Peak Temperature	90 to 110°C	100 to 120°C
Soldering Peak Temperature	240 to 250°C	250 to 260°C
Atmosphere	Air	Air

Pb-Sn Solder: Sn-37Pb

Lead Free Solder: Sn-3.0Ag-0.5Cu

5. Optimum Solder Amount for Flow Soldering

5-1. The top of the solder fillet should be lower than the thickness of components. If the solder amount is excessive, the risk of cracking is higher during board bending or any other stressful condition.

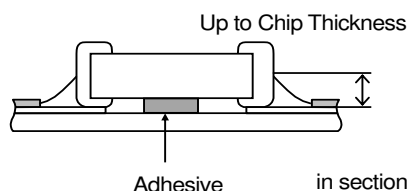

[Standard Conditions for Flow Soldering]

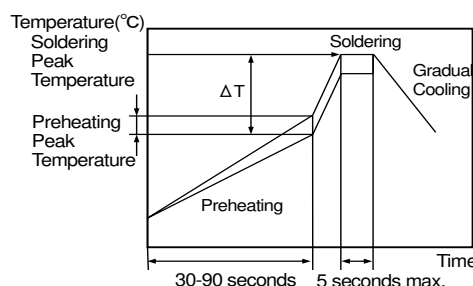

[Allowable Flow Soldering Temperature and Time]

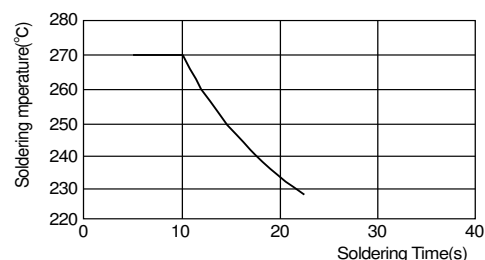

In the case of repeated soldering, the accumulated soldering time must be within the range shown above.

4-3. Correction of Soldered Portion

When sudden heat is applied to the capacitor, distortion caused by the large temperature difference occurs internally, and can be the cause of cracks. Capacitors also tend to be affected by mechanical and thermal stress depending on the board preheating temperature or the soldering fillet shape, and can be the cause of cracks. Please refer to "1. PCB Design" or "3. Optimum solder amount" for the solder amount and the fillet shapes.

1. Correction with a Soldering Iron

- 1-1. In order to reduce damage to the capacitor, be sure to preheat the capacitor and the mounting board. Preheat to the temperature range shown in Table 3. A hot plate, hot air type preheater, etc. can be used for preheating.
- 1-2. After soldering, do not allow the component/PCB to cool down rapidly.
- 1-3. Perform the corrections with a soldering iron as quickly as possible. If the soldering iron is applied too long, there is a possibility of causing solder leaching on the terminal electrodes, which will cause deterioration of the adhesive strength and other problems.

Table 3

Part Number	Temperature of Soldering Iron tip	Preheating Temperature	Temperature Differential(ΔT)	Atmosphere
GRT03/15/18/21/31	350°C max.	150°C min.	ΔT ≤ 190°C	Air
GRT32	280°C max.	150°C min.	ΔT ≤ 130°C	Air

*Applicable for both Pb-Sn and Lead Free Sold Pb-Sn Solder: Sn-37Pb
Lead Free Solder: Sn-3.0Ag-0.5Cu

2. Correction with Spot Heater

Compared to local heating with a soldering iron, hot air heating by a spot heater heats the overall component and board, therefore, it tends to lessen the thermal shock. In the case of a high density mounted board, a spot heater can also prevent concerns of the soldering iron making direct contact with the component.

- 2-1. If the distance from the hot air outlet of the spot heater to the component is too close, cracks may occur due to thermal shock. To prevent this problem, follow the conditions shown in Table 4.
- 2-2. In order to create an appropriate solder fillet shape, it is recommended that hot air be applied at the angle shown in Figure 1.

Table 4

Distance	5mm or more
Hot Air Application angle	45° *Figure 1
Hot Air Temperature Nozzle Outlet	400°C max.
Application Time	Less than 10 seconds (1206 (in inch) / (3216 (in mm) size or smaller)
	Less than 30 seconds (1210 (in inch) / 3225 (in mm) size or larger)

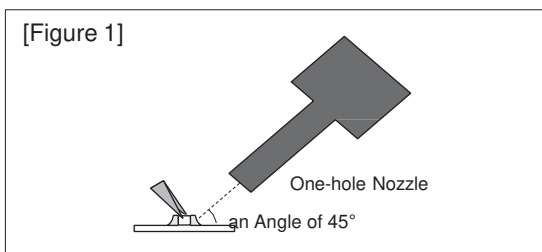

3. Optimum solder amount when re-working with a soldering iron

- 3-1. In the case of 0603 (in inch) / 1608 (in mm) and smaller sizes (GRT03/15/18), the top of the solder fillet should be lower than 2/3 of the thickness of the component or 0.5mm, whichever is smaller. In the case of 0805 (in inch) / 2012(in mm) and larger sizes (GRT21/31/32), the top of the solder fillet should be lower than 2/3 of the thickness of the component. If the solder amount is excessive, the risk of cracking is higher during board bending or under any other stressful condition.
- 3-2. A soldering iron with a tip of ø3mm or smaller should be used. It is also necessary to keep the soldering iron from touching the components during the re-work.
- 3-3. Solder wire with ø0.5mm or smaller is required for soldering.

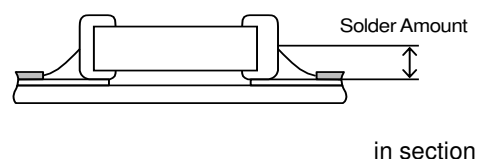

5. Washing

Excessive ultrasonic oscillation during cleaning can cause the PCBs to resonate, resulting in cracked chips or broken solder joints. Take note not to vibrate PCBs.

6. Electrical Test on Printed Circuit Board

1. Confirm position of the backup pin or specific jig, when inspecting the electrical performance of a capacitor after mounting on the printed circuit board.

1-1. Avoid bending the printed circuit board by the pressure of a test-probe, etc.
 The thrusting force of the test probe can flex the PCB, resulting in cracked chips or open solder joints. Provide backup pins on the back side of the PCB to prevent warping or flexing. Install backup pins as close to the test-probe as possible.

1-2. Avoid vibration of the board by shock when a test -probe contacts a printed circuit board.

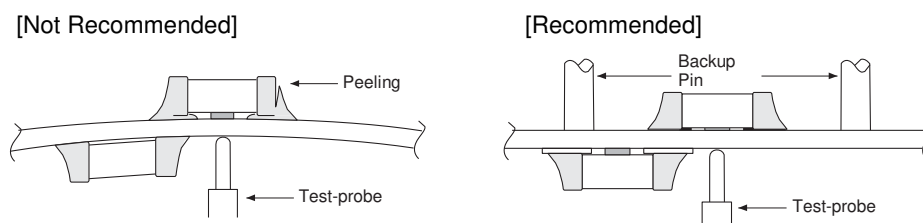

7. Printed Circuit Board Cropping

1. After mounting a capacitor on a printed circuit board, do not apply any stress to the capacitor that caused bending or twisting the board.

1-1. In cropping the board, the stress as shown at right may cause the capacitor to crack.
 Cracked capacitors may cause deterioration of the insulation resistance, and result in a short. Avoid this type of stress to a capacitor.



2. Check the cropping method for the printed circuit board in advance.

2-1. Printed circuit board cropping shall be carried out by using a jig or an apparatus (Disk separator, router type separator, etc.) to prevent the mechanical stress that can occur to the board.

Board Separation Method	Hand Separation Nipper Separation	(1) Board Separation Jig	Board Separation Apparatus	
			2) Disk Separator	3) Router Type Separator
Level of stress on board	High	Medium	Medium	Low
Recommended	x	△*	△*	○
Notes	Hand and nipper separation apply a high level of stress. Use another method.	· Board handling · Board bending direction · Layout of capacitors	· Board handling · Layout of slits · Design of V groove · Arrangement of blades · Controlling blade life	Board handling

* When a board separation jig or disk separator is used, if the following precautions are not observed, a large board deflection stress will occur and the capacitors may crack.
 Use router type separator if at all possible.

(1) Example of a suitable jig

[In the case of Single-side Mounting]

An outline of the board separation jig is shown as follows.

Recommended example: Stress on the component mounting position can be minimized by holding the portion close to the jig, and bend in the direction towards the side where the capacitors are mounted.

Not recommended example: The risk of cracks occurring in the capacitors increases due to large stress being applied to the component mounting position, if the portion away from the jig is held and bent in the direction opposite the side where the capacitors are mounted.

[Outline of jig]



[In the case of Double-sided Mounting]

Since components are mounted on both sides of the board, the risk of cracks occurring can not be avoided with the above method. Therefore, implement the following measures to prevent stress from being applied to the components.

(Measures)

(1) Consider introducing a router type separator.

If it is difficult to introduce a router type separator, implement the following measures.

(Refer to item 1. Mounting Position)

(2) Mount the components parallel to the board separation surface.

(3) When mounting components near the board separation point, add slits in the separation position near the component.

(4) Keep the mounting position of the components away from the board separation point.

(2) Example of a Disk Separator

An outline of a disk separator is shown as follows. As shown in the Principle of Operation, the top blade and bottom blade are aligned with the V-grooves on the printed circuit board to separate the board.

In the following case, board deflection stress will be applied and cause cracks in the capacitors.

(1) When the adjustment of the top and bottom blades are misaligned, such as deviating in the top-bottom, left-right or front-rear directions

(2) The angle of the V groove is too low, depth of the V groove is too shallow, or the V groove is misaligned top-bottom

IF V groove is too deep, it is possible to brake when you handle and carry it. Carefully design depth of the V groove with consideration about strength of material of the printed circuit board.

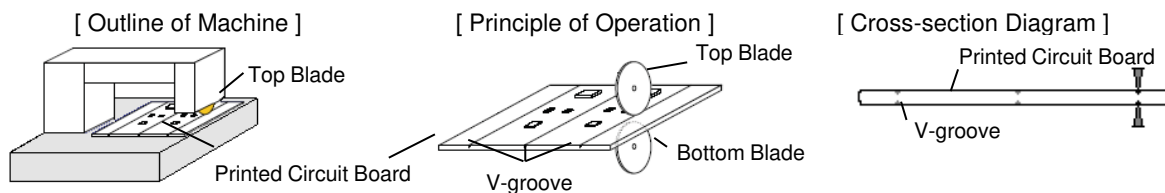

Recommended	Not recommended		
	Top-bottom Misalignment	Left-right Misalignment	Front-rear Misalignment
Top Blade	Top Blade	Top Blade	Top Blade
Bottom Blade	Bottom Blade	Bottom Blade	Bottom Blade

Example of Recommended	Not Recommended			
	Left-right Misalignment	Low-Angle	Depth too Shallow	Depth too Deep

(3) Example of Router Type Separator

The router type separator performs cutting by a router rotating at a high speed. Since the board does not bend in the cutting process, stress on the board can be suppressed during board separation.

When attaching or removing boards to/from the router type separator, carefully handle the boards to prevent bending.

[Outline Drawing]



8. Assembly

1. Handling

If a board mounted with capacitors is held with one hand, the board may bend.

Firmly hold the edges of the board with both hands when handling.

If a board mounted with capacitors is dropped, cracks may occur in the capacitors.

Do not use dropped boards, as there is a possibility that the quality of the capacitors may be impaired.

2. Attachment of Other Components

2-1. Mounting of Other Components

Pay attention to the following items, when mounting other components on the back side of the board after capacitors have been mounted on the opposite side.

When the bottom dead point of the suction nozzle is set too low, board deflection stress may be applied to the capacitors on the back side (bottom side), and cracks may occur in the capacitors.

- After the board is straightened, set the bottom dead point of the nozzle on the upper surface of the board.
- Periodically check and adjust the bottom dead point.



2-2. Inserting Components with Leads into Boards

When inserting components (transformers, IC, etc.) into boards, bending the board may cause cracks in the capacitors or cracks in the solder. Pay attention to the following.

- Increase the size of the holes to insert the leads, to reduce the stress on the board during insertion.
- Fix the board with backup pins or a dedicated jig before insertion.
- Support below the board so that the board does not bend. When using multiple backup pins on the board, periodically confirm that there is no difference in the height of each backup pin.



2-3. Attaching/Removing Sockets

When the board itself is a connector, the board may bend when a socket is attached or removed.

Plan the work so that the board does not bend when a socket is attached or removed.



2-4. Tightening Screws

The board may be bent, when tightening screws, etc. during the attachment of the board to a shield or chassis. Pay attention to the following items before performing the work.

- Plan the work to prevent the board from bending.
- Use a torque screwdriver, to prevent over-tightening of the screws.
- The board may bend after mounting by reflow soldering, etc. Please note, as stress may be applied to the chips by forcibly flattening the board when tightening the screws.



■ Others

1. Under Operation of Equipment

- 1-1. Do not touch a capacitor directly with bare hands during operation in order to avoid the danger of an electric shock.
- 1-2. Do not allow the terminals of a capacitor to come in contact with any conductive objects (short-circuit).
Do not expose a capacitor to a conductive liquid, inducing any acid or alkali solutions.
- 1-3. Confirm the environment in which the equipment will operate is under the specified conditions.
Do not use the equipment under the following environments.
 - (1) Being splattered with water or oil.
 - (2) Being exposed to direct sunlight.
 - (3) Being exposed to ozone, ultraviolet rays, or radiation.
 - (4) Being exposed to toxic gas (e.g., hydrogen sulfide, sulfur dioxide, chlorine, ammonia gas etc.)
 - (5) Any vibrations or mechanical shocks exceeding the specified limits.
 - (6) Moisture condensing environments.
- 1-4. Use damp proof countermeasures if using under any conditions that can cause condensation.

2. Others

- 2-1. In an Emergency
 - (1) If the equipment should generate smoke, fire, or smell, immediately turn off or unplug the equipment.
If the equipment is not turned off or unplugged, the hazards may be worsened by supplying continuous power.
 - (2) In this type of situation, do not allow face and hands to come in contact with the capacitor or burns may be caused by the capacitor's high temperature.
- 2-2. Disposal of waste
When capacitors are disposed of, they must be burned or buried by an industrial waste vendor with the appropriate licenses.
- 2-3. Circuit Design
 - (1) Addition of Fail Safe Function
Capacitors that are cracked by dropping or bending of the board may cause deterioration of the insulation resistance, and result in a short. If the circuit being used may cause an electrical shock, smoke or fire when a capacitor is shorted, be sure to install fail-safe functions, such as a fuse, to prevent secondary accidents.
 - (2) The GRT series are not safety standard certified products.
- 2-4. Remarks
Failure to follow the cautions may result, worst case, in a short circuit and smoking when the product is used.
The above notices are for standard applications and conditions. Contact us when the products are used in special mounting conditions.
Select optimum conditions for operation as they determine the reliability of the product after assembly.
The data herein are given in typical values, not guaranteed ratings.

■ Rating

1. Operating Temperature

1. The operating temperature limit depends on the capacitor.
 - 1-1. Do not apply temperatures exceeding the upper operating temperature.
It is necessary to select a capacitor with a suitable rated temperature that will cover the operating temperature range.
It is also necessary to consider the temperature distribution in equipment and the seasonal temperature variable factor.
 - 1-2. Consider the self-heating factor of the capacitor
The surface temperature of the capacitor shall be the upper operating temperature or less when including the self-heating factors.

2. Atmosphere Surroundings (gaseous and liquid)

1. Restriction on the operating environment of capacitors.
 - 1-1. Capacitors, when used in the above, unsuitable, operating environments may deteriorate due to the corrosion of the terminations and the penetration of moisture into the capacitor.
 - 1-2. The same phenomenon as the above may occur when the electrodes or terminals of the capacitor are subject to moisture condensation.
 - 1-3. The deterioration of characteristics and insulation resistance due to the oxidization or corrosion of terminal electrodes may result in breakdown when the capacitor is exposed to corrosive or volatile gases or solvents for long periods of time.

3. Piezo-electric Phenomenon

1. When using high dielectric constant type capacitors in AC or pulse circuits, the capacitor itself vibrates at specific frequencies and noise may be generated.
Moreover, when the mechanical vibration or shock is added to capacitor, noise may occur.

■ Soldering and Mounting

1. PCB Design

1. Notice for Pattern Forms

1-1. Unlike leaded components, chip components are susceptible to flexing stresses since they are mounted directly on the substrate. They are also more sensitive to mechanical and thermal stresses than leaded components. Excess solder fillet height can multiply these stresses and cause chip cracking. When designing substrates, take land patterns and dimensions into consideration to eliminate the possibility of excess solder fillet height.

1-2. There is a possibility of chip cracking caused by PCB expansion/contraction with heat, because stress on a chip is different depending on PCB material and structure. When the thermal expansion coefficient greatly differs between the board used for mounting and the chip, it will cause cracking of the chip due to the thermal expansion and contraction. When capacitors are mounted on a fluorine resin printed circuit board or on a single-layered glass epoxy board, it may also cause cracking of the chip for the same reason.

Pattern Forms

	Prohibited	Correct
Placing Close to Chassis		
Placing of Chip Components and Leaded Components		
Placing of Leaded Components after Chip Component		
Lateral Mounting		

2. Land Dimensions

2-1. Chip capacitors can be cracked due to the stress of PCB bending , etc. if the land area is larger than needed and has an excess amount of solder. Please refer to the land dimensions in table 1 for flow soldering, table 2 for reflow soldering.



Please confirm the suitable land dimension by evaluating of the actual SET / PCB.

Table 1 Flow Soldering Method

Dimensions Part Number	L×W	a	b	c
GRT18	1.6×0.8	0.6 to 1.0	0.8 to 0.9	0.6 to 0.8
GRT21	2.0×1.25	1.0 to 1.2	0.9 to 1.0	0.8 to 1.1
GRT31	3.2×1.6	2.2 to 2.6	1.0 to 1.1	1.0 to 1.4

Flow soldering can only be used for products with a chip size of 1.6x0.8mm to 3.2x1.6mm. (in mm)

Table 2 Reflow Soldering Method

Dimensions Part Number	L×W	a	b	c
GRT03	0.6×0.3	0.2 to 0.3	0.2 to 0.35	0.2 to 0.4
GRT15	1.0×0.5	0.3 to 0.5	0.35 to 0.45	0.4 to 0.6
GRT18	1.6×0.8	0.6 to 0.8	0.6 to 0.7	0.6 to 0.8
GRT21	2.0×1.25	1.0 to 1.2	0.6 to 0.7	0.8 to 1.1
GRT31	3.2×1.6	2.2 to 2.4	0.8 to 0.9	1.0 to 1.4
GRT32	3.2×2.5	2.0 to 2.4	1.0 to 1.2	1.8 to 2.3

(in mm)

3. Board Design

When designing the board, keep in mind that the amount of strain which occurs will increase depending on the size and material of the board.

Relationship with amount of strain to the board thickness, length, width, etc.]

$$\epsilon = \frac{3PL}{2Ewh^2}$$

Relationship between load and strain

ϵ : Strain on center of board (μs)
 L : Distance between supporting points (mm)
 w : Board width (mm)
 h : Board thickness (mm)
 E : Elastic modulus of board ($\text{N/m}^2 = \text{Pa}$)
 Y : Deflection (mm)
 P : Load (N)

When the load is constant, the following relationship can be established.

- As the distance between the supporting points (L) increases, the amount of strain also increases.
 → Reduce the distance between the supporting points.
- As the elastic modulus (E) decreases, the amount of strain increases.
 → Increase the elastic modulus.
- As the board width (w) decreases, the amount of strain increases.
 → Increase the width of the board.
- As the board thickness (h) decreases, the amount of strain increases.
 → Increase the thickness of the board.

Since the board thickness is squared, the effect on the amount of strain becomes even greater.

2. Adhesive Application

- Thin or insufficient adhesive can cause the chips to loosen or become disconnected during flow soldering. The amount of adhesive must be more than dimension c , shown in the drawing at right, to obtain the correct bonding strength. The chip's electrode thickness and land thickness must also be taken into consideration.



- Low viscosity adhesive can cause chips to slip after mounting. The adhesive must have a viscosity of $5000\text{Pa} \cdot \text{s}$ (500ps) min. (at 25°C)

3. Adhesive Coverage

Size (LxW) (in mm)	Adhesive Coverage*
1.6 x 0.8	0.05mg min.
2.0 x 1.25	0.1mg min.
3.2 x 1.6	0.15mg min.

*Nominal Value

3. Adhesive Curing

- Insufficient curing of the adhesive can cause chips to disconnect during flow soldering and causes deterioration in the insulation resistance between the outer electrodes due to moisture absorption. Control curing temperature and time in order to prevent insufficient hardening.

4. Flux

- An excessive amount of flux generates a large quantity of flux gas, which can cause a deterioration of solderability, so apply flux thinly and evenly throughout. (A foaming system is generally used for flow soldering.)
- Flux containing too high a percentage of halide may cause corrosion of the outer electrodes unless there is sufficient cleaning. Use flux with a halide content of 0.1% max.
- Do not use strong acidic flux.
- Do not use water-soluble flux.*
 (*Water-soluble flux can be defined as non-rosin type flux including wash-type flux and non-wash-type flux.)

5. Flow Soldering

Set temperature and time to ensure that leaching of the outer electrode does not exceed 25% of the chip end area as a single chip (full length of the edge A-B-C-D shown at right) and 25% of the length A-B shown as mounted on substrate.



6. Washing

1. Please evaluate the capacitor using actual cleaning equipment and conditions to confirm the quality, and select the solvent for cleaning.
2. Unsuitable cleaning solvent may leave residual flux or other foreign substances, causing deterioration of electrical characteristics and the reliability of the capacitors.
3. Select the proper cleaning conditions.
 - 3-1. Improper cleaning conditions (excessive or insufficient) may result in the deterioration of the performance of the capacitors.

7. Coating

1. A crack may be caused in the capacitor due to the stress of the thermal contraction of the resin during curing process. The stress is affected by the amount of resin and curing contraction. Select a resin with low curing contraction. The difference in the thermal expansion coefficient between a coating resin or a molding resin and the capacitor may cause the destruction and deterioration of the capacitor such as a crack or peeling, and lead to the deterioration of insulation resistance or dielectric breakdown. Select a resin for which the thermal expansion coefficient is as close to that of the capacitor as possible. A silicone resin can be used as an under-coating to buffer against the stress.
2. Select a resin that is less hygroscopic. Using hygroscopic resins under high humidity conditions may cause the deterioration of the insulation resistance of a capacitor. An epoxy resin can be used as a less hygroscopic resin.

■ Others

1. Transportation

1. The performance of a capacitor may be affected by the conditions during transportation.
 - 1-1. The capacitors shall be protected against excessive temperature, humidity and mechanical force during transportation.
 - (1) Climatic condition
 - low air temperature : -40°C
 - change of temperature air/air : -25°C/+25°C
 - low air pressure : 30 kPa
 - change of air pressure : 6 kPa/min.
 - (2) Mechanical condition

Transportation shall be done in such a way that the boxes are not deformed and forces are not directly passed on to the inner packaging.
 - 1-2. Do not apply excessive vibration, shock, or pressure to the capacitor.
 - (1) When excessive mechanical shock or pressure is applied to a capacitor, chipping or cracking may occur in the ceramic body of the capacitor.
 - (2) When the sharp edge of an air driver, a soldering iron, tweezers, a chassis, etc. impacts strongly on the surface of the capacitor, the capacitor may crack and short-circuit.
 - 1-3. Do not use a capacitor to which excessive shock was applied by dropping etc. A capacitor dropped accidentally during processing may be damaged.

2. Characteristics Evaluation in the Actual System

1. Evaluate the capacitor in the actual system, to confirm that there is no problem with the performance and specification values in a finished product before using.
2. Since a voltage dependency and temperature dependency exists in the capacitance of high dielectric type ceramic capacitors, the capacitance may change depending on the operating conditions in the actual system. Therefore, be sure to evaluate the various characteristics, such as the leakage current and noise absorptivity, which will affect the capacitance value of the capacitor.
3. In addition, voltages exceeding the predetermined surge may be applied to the capacitor by the inductance in the actual system. Evaluate the surge resistance in the actual system as required.

1. Please make sure that your product has been evaluated in view of your specifications with our product being mounted to your product.
2. You are requested not to use our product deviating from this product specification.
3. We consider it not appropriate to include any terms and conditions with regard to the business transaction in the product specifications, drawings or other technical documents. Therefore, if your technical documents as above include such terms and conditions such as warranty clause, product liability clause, or intellectual property infringement liability clause, they will be deemed to be invalid.
4. GRT series is manufactured under a quality management system compliant to ISO9001, but is not registered to ISO/TS16949.