

# MULTI LINE MODULE CONNECTORS

## 8071/8072シリーズ標準タイプ 嵌合組み合わせ表

## Mating combination table for 8071 and 8072 Series standard type connectors

Type		Receptacle																																			
		8071 (Right angle)						8072 (Vertical)																													
		A		B		C		CR		AB		B																									
Pos.		110		95		110		125		55		55		125		110		95		110		125															
Variation	Key	●	●	●	●							●	●	●	●	●	●	●	●																		
	Boss	●		●							●			●			●	●																			
	Shield			●	●		●		●			●	●			●	●		●	●		●	●														
Ordering Code		27 8071 110 001 *** +		27 8071 110 002 *** +		27 8071 110 011 *** +		27 8071 110 012 *** +		27 8071 095 000 *** +		27 8071 095 010 *** +		27 8071 110 000 *** +		27 8071 110 010 *** +		27 8071 125 000 *** +		27 8071 125 010 *** +		27 8071 055 001 *** +		27 8071 055 002 *** +		27 8071 055 011 *** +		27 8071 055 012 *** +		27 8071 055 001 *** D +		27 8071 055 002 *** D +		27 8071 055 011 *** D +		27 8071 055 012 *** D +	

  

Type	Pos.	Variation		Ordering Code	
		Key	Boss		
8071 (Vertical)	A	154	● ●	17 8071 154 001 *** +	
		133	- -	17 8071 133 000 *** +	
	B	154	- -	17 8071 154 000 *** +	
		175	- -	17 8071 175 000 *** +	
	C	77	● ●	17 8071 077 512 *** +	
8072 (Right angle)	CR	77	● ●	17 8071 077 512 *** D+	
	AB	169	● -	17 8071 169 512 *** +	
	A	110	● -	17 8072 110 001 *** +	
	B		95	- -	17 8072 095 000 *** +
			110	- -	17 8072 110 000 *** +
		125	- -	17 8072 125 000 *** +	
With latch	55	- -	17 8072 125 200 *** +		

### 型番構成 Ordering Code

#### 8071 Series

##### ■ Plug

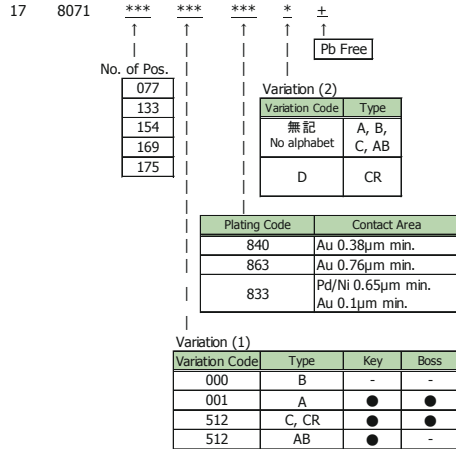

##### ■ Receptacle

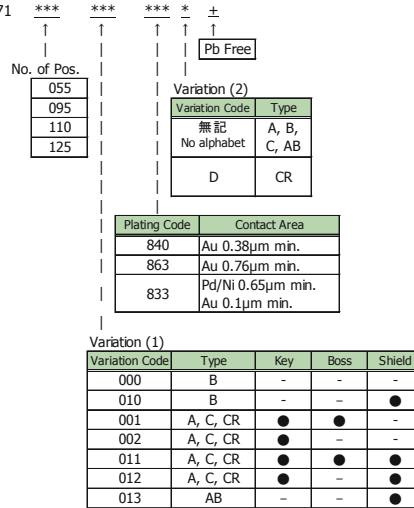

#### 8072 Series

##### ■ Plug

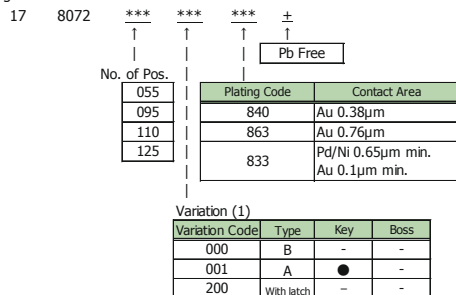

##### ■ Receptacle

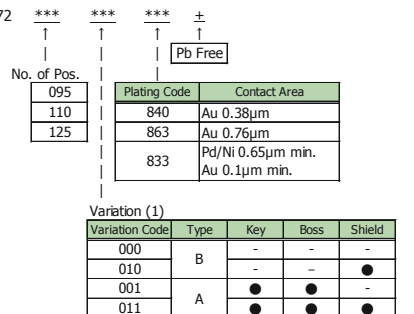

# MULTI LINE MODULE CONNECTORS

SERIES

# 8071

## プラグストレート TYPE A, TYPE B Plug Straight

### Back Planes TYPE A

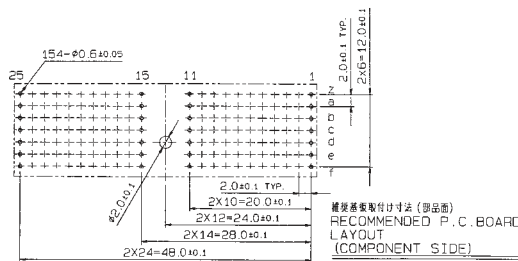
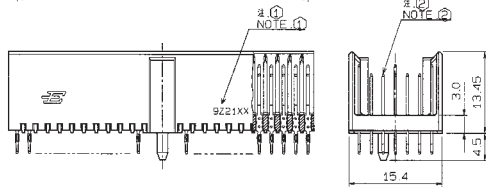
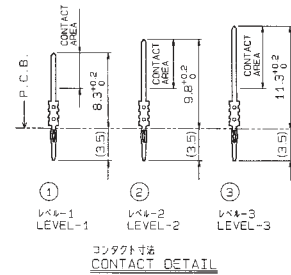
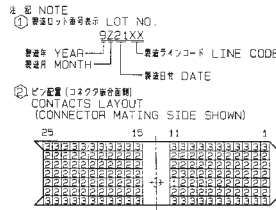
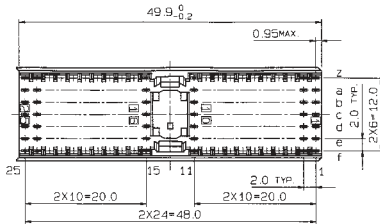

### 注文コード Ordering Code

17 8071 154 001 XXX +

**VARIATION**  
001 : Type A 154P  
(キー付STD.タイプ/With coding key STD. type)

**FINISH CODE**  
840 : Au0.38μm  
863 : Au0.76μm  
833 : Pd/Ni0.65

### Back Planes TYPE B

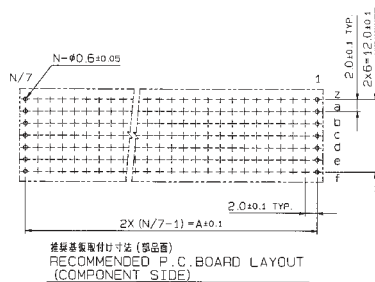
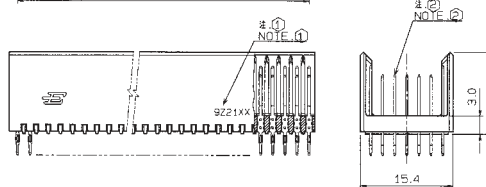
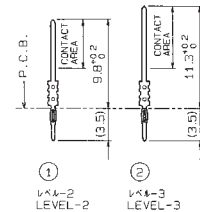
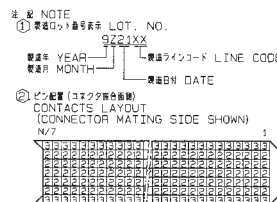
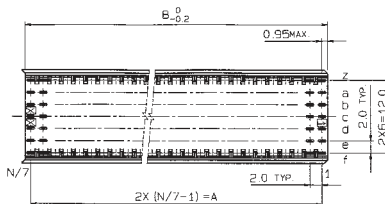

ORDERING CODE	A	B
17 8071 133 000 XXX	36.0	37.9
17 8071 154 000 XXX	42.0	43.9
17 8071 175 000 XXX	48.0	49.9

### 注文コード Ordering Code

17 8071 XXX 000 XXX +

**NUMBER OF CONTACTS**  
133 : 133P 95signal+38ground  
154 : 154P 110signal+44ground  
175 : 175P 125signal+50ground

**VARIATION**  
000 : Type B  
(キー無STD.タイプ/Without coding key STD. type)

**FINISH CODE**  
840 : Au0.38μm  
863 : Au0.76μm  
833 : Pd/Ni0.65

# MULTI LINE MODULE CONNECTORS

SERIES

# 8071

## プラグ ストレート TYPE C, TYPE CR Plug Straight

### Back Planes TYPE C

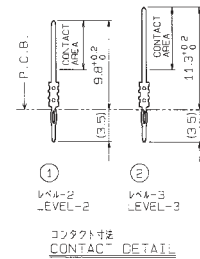
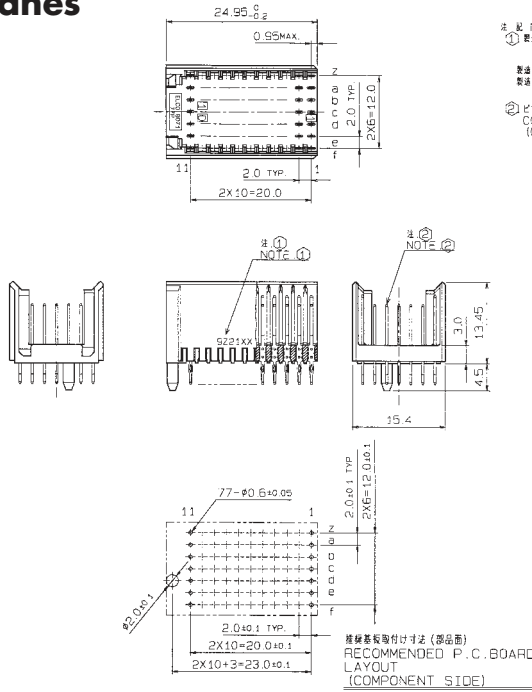

### 注文コード Ordering Code

17 8071 077 512 XXX +

### FINISH CODE

840 : Au0.38μm  
863 : Au0.76μm  
833 : Pd/Ni0.65

### Back Planes TYPE CR

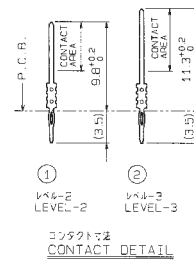
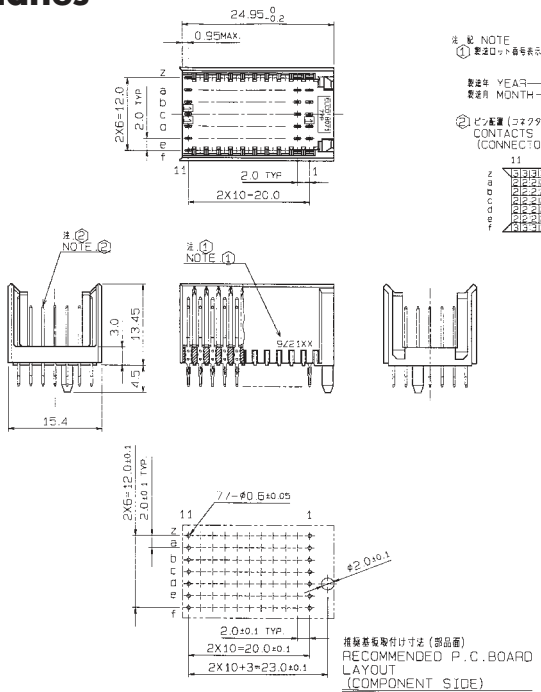

### 注文コード Ordering Code

17 8071 077 512 XXX D+

### FINISH CODE

840 : Au0.38μm  
863 : Au0.76μm  
833 : Pd/Ni0.65

# MULTI LINE MODULE CONNECTORS

SERIES

# 8071

## プラグコンタクト レベル表 Plug Contact Level

8071シリーズプラグコネクタには、長さ別に12種類のピンコンタクトが、用意されています。用途に応じて選択されたピンコンタクトとその配列をオーダーすることができます。

Pin arrangement is at user's option. Please apply to the sales department of KYOCERA Corporation for the request of pin arrangement.

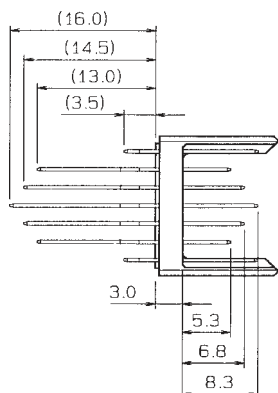
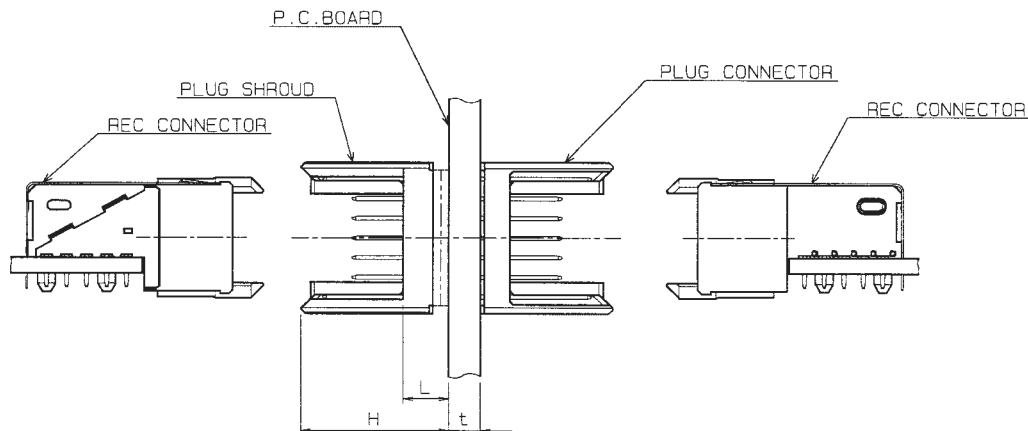

### ピンコンタクト配列上の注意点

- ・ドーターボードに取り付けられたA、B、C、Dタイプ・リセプタクル・コネクタと嵌合させる場合は、b列にコンタクトコード：3、K、N、Tは、装填できません。

### プラグコネクタ ピン配列オーダー手順

- ・用途に応じた長さのピンコンタクトをコンタクトバリエーションの表の中から選択し、そのコンタクトコードを下記の必要なコネクタコラムA～Cの中にすべて記入して下さい。
- ・空きピンを要望される場合は、記入漏れが無いようスラッシュを記入して下さい。

### NOTES

In case of you mate a Receptacle Connector of A, B, C type on your Daughter board, we could not support to insert contact (contact code 3, K, N, T) in B row. If you need a specially loaded configuration for your application, please use this form. Fill out the grid diagram for the connector style you desire (A, B, C) and mark which pin (3, 2, 1, K, L, M, N, P, S, T, U, W) is required in each position. If you want blank position connector, please write (/) on this sheets.

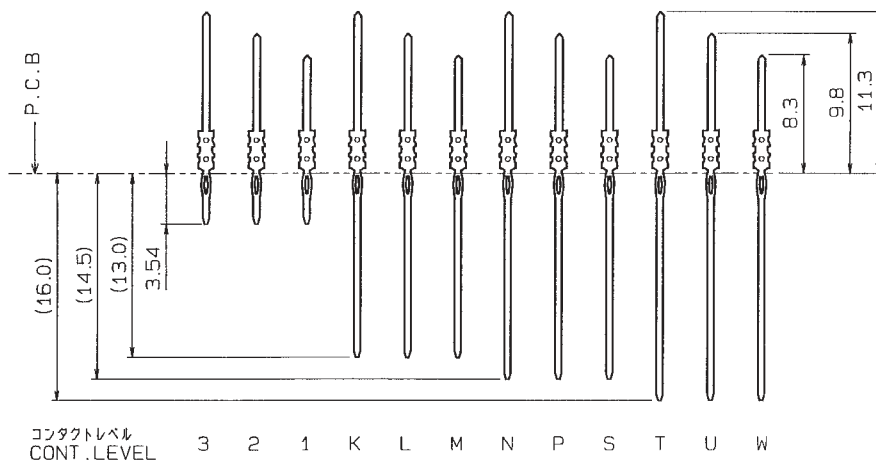

# MULTI LINE MODULE CONNECTORS

SERIES

# 8071

## リセプタクル ライトアングル TYPE A Receptacle Right Angle

### Daughter Card TYPE A

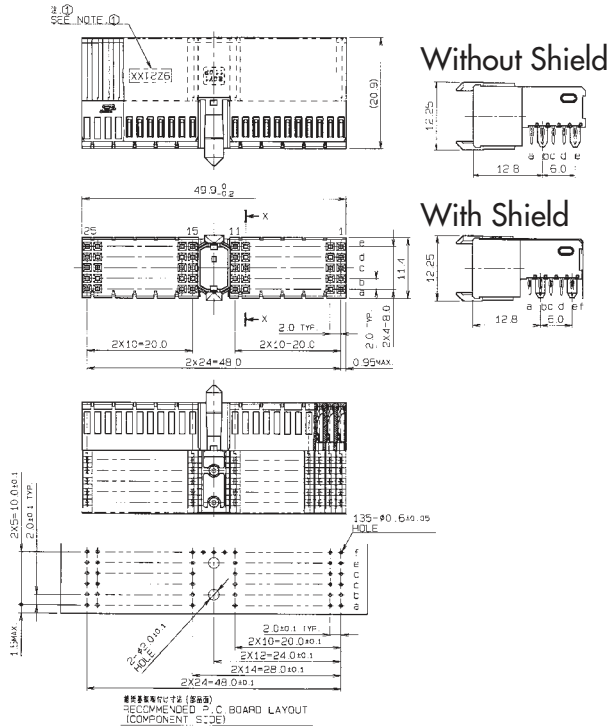

注記 NOTE  
 ① 製造ロット番号表示 LOT. NO. 9Z21XX  
 製造年 YEAR 製造ラインコード LINE CODE  
 製造月 MONTH 製造日付 DATE  
 2. ②列には下記に示すプラグコンタクトは挿入不可。  
 THOSE PLUG CONTACTS AS SHOWN BELOW  
 ARE NOT PERMITTED TO INSERT ON ROW-b.  
 フロント面側: レベル-3, K, N, T  
 バック面側: レベル-T, U, W  
 FRONT SIDE: LEVEL-3, K, N, T  
 BACK SIDE: LEVEL-T, U, W  
 3. 適用基板仕様 APPLICABLE P.C. BOARD  
 基板厚 P.C. BOARD THICKNESS:  
 t=1.4~4.2mm  
 穴径仕様 APPLICABLE T/H  
 穴径 PREPARED HOLE DIA.:  
 φ0.7±0.025mm  
 銅メッキ厚 COPPER PLATING THICKNESS:  
 25~50μm  
 (半田メッキ SOLDER PLATING: 4~10μm)  
 仕上げ径 FINAL PLATED HOLE DIA.:  
 φ0.6±0.05mm

### 注文コード Ordering Code

27 8071 110 XXX XXX +

#### VARIATION

- 001: TYPE A 110P (キー付シールド無、ボス有り)  
(with coding key, without shield, with boss)
- 002: TYPE A 110P (キー付シールド無、ボス無し)  
(with coding key, without shield, without boss)
- 011: TYPE A 110P (キー付シールド有り、ボス有り)  
(with coding key, with shield, with boss)
- 012: TYPE A 110P (キー付シールド有り、ボス無し)  
(with coding key, with shield, without boss)

#### FINISH CODE

- 840: Au0.38μm
- 863: Au0.76μm
- 833: Pd/Ni0.65

### Bottom Shield TYPE A

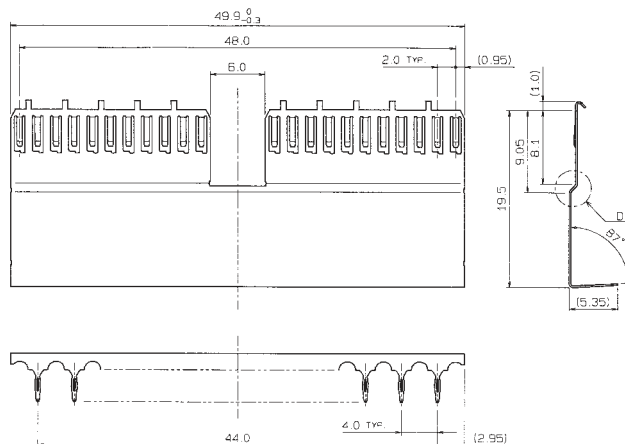

### Example

Without Bottom Shield

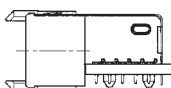

With Bottom Shield

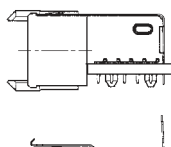

### 注文コード Ordering Code

82 8071 110 501 XXX +

#### FINISH CODE

- 840: Au0.38μm
- 863: Au0.76μm
- 833: Pd/Ni0.65

# MULTI LINE MODULE CONNECTORS

SERIES

# 8071

## リセプタクル ライトアングル TYPE B

### Receptacle Right Angle

### Daughter Card TYPE B

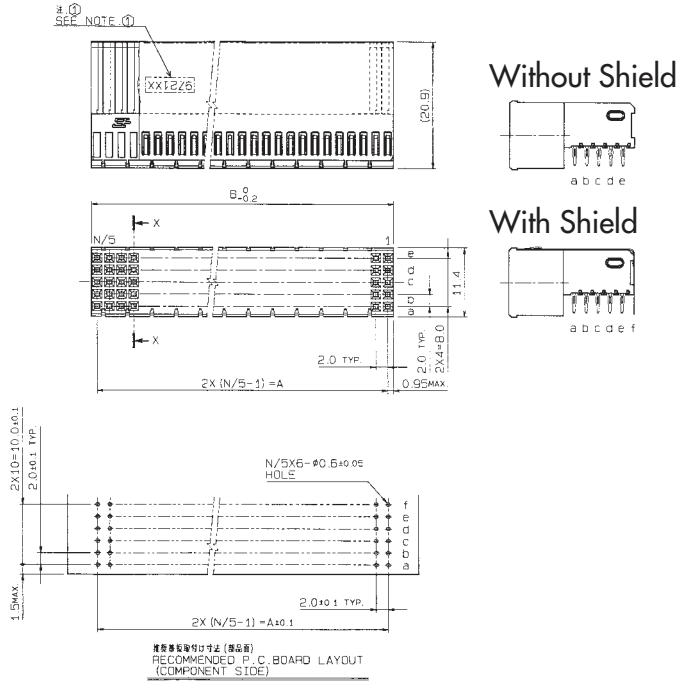

NO. OF POS.	A	B
95	36.0	37.9
110	42.0	43.9
125	48.0	49.9

※ 1. NOTE  
 ① 製造ロット番号表示: LOT. NO. 9221XX  
 製造年 YEAR: 製造ラインコード LINE CODE  
 製造月 MONTH: 製造日 DATE

2. ② 別紙に示す端子ボルトの規格は参照し、  
 THESE PLUG CONTACTS AS SHOWN BELOW  
 ARE NOT PERMITTED TO INSERT ON ROW-B.  
 ボルト規格: レベル-B, K, N, T  
 ボルト径: レベル-T, U, W  
 FRONT SIDE: LEVEL-B, K, N, T  
 BACK SIDE: LEVEL-T, U, W

3. 適用基板仕様: APP. ICABLE P.C. BOARD  
 適用 PCB BOARD THICKNESS:  
 t=1.4~2.0mm  
 穴径仕様: APPLICABLE T/H:  
 穴径 PREPARED HOLE DIA.:  
 #0.7±0.025mm  
 銅めっき厚: COPPER PLATING THICKNESS:  
 25~50nm  
 (\*#X) 溶剤: SOLDER PLATING: 4~10μm  
 仕上げ: FINAL PLATED HOLE DIA.:  
 #0.6±0.05mm

### 注文コード Ordering Code

27 8071 XXX XXX XXX +

#### NUMBER OF CONTACTS

095 : 95P 95signal  
 110 : 110P 110signal  
 125 : 125P 125signal

#### VARIATION

000 : TYPE B 95, 110, 125P (キー無しシールド無)  
 (without coding key, without shield)  
 010 : TYPE B 95, 110, 125P (キー無しシールド有)  
 (without coding key, with shield)

#### FINISH CODE

840 : Au0.38μm  
 863 : Au0.76μm  
 833 : Pd/Ni0.65

### Bottom Shield TYPE B

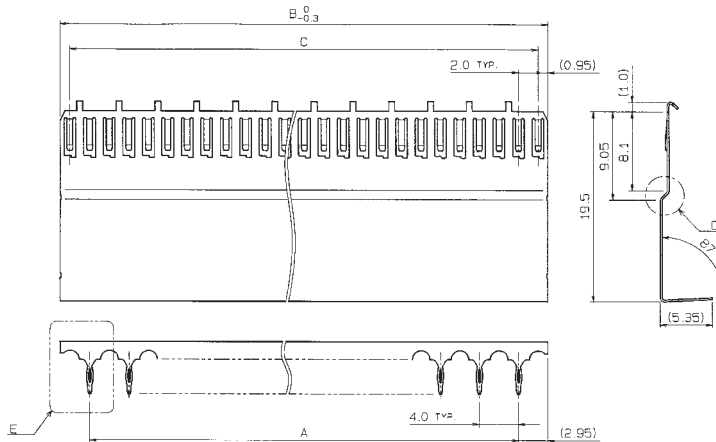

キー-マウント VARIATION 1	A	B	C
055	16.0	21.9	20.0
095	32.0	37.9	36.0
110	40.0	43.9	42.0
125	44.0	49.9	48.0

### Example

Without Bottom Shield

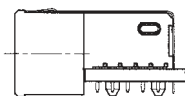

With Bottom Shield

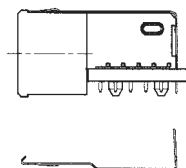

### 注文コード Ordering Code

82 8071 XXX 500 XXX +

#### NUMBER OF CONTACTS

095 : 95P 95signal  
 110 : 110P 110signal  
 125 : 125P 125signal

#### FINISH CODE

840 : Au0.38μm  
 863 : Au0.76μm  
 833 : Pd/Ni0.65

MULTI LINE MODULE CONNECTORS

SERIES

8071

リセプタクル ライトアングル TYPE C, CR  
Receptacle Right Angle

Daughter Card

TYPE C, CR

Without Shield

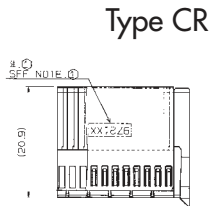
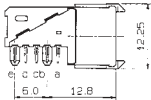

With Shield

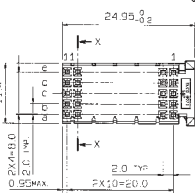
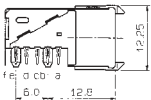

Type C

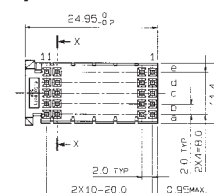
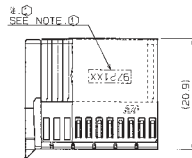

Without Shield

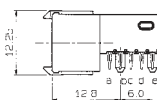

With Shield

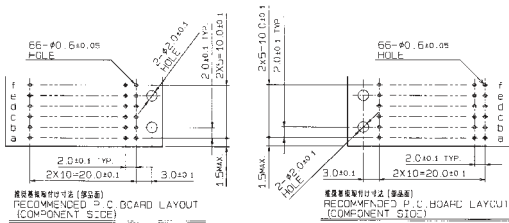
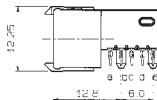

NOTE  
SERIAL LOT NO.  
YEAR MONTH DATE  
LINE CODE  
DATE  
THOSE PLUG CONTACTS AS SHOWN BELOW ARE NOT PERMITTED TO INSERT ON P.C.B.  
FRONT SIDE: LEVEL-3, K, N, T  
BACK SIDE: LEVEL-1, U, W  
APPLICABLE P.C.B. BOARD  
P.C. BOARD THICKNESS:  
- 1.6±0.2mm  
APPLICABLE T/H  
PREPARED HOLE DIA.:  
#0.7±0.025mm  
COPPER PLATING THICKNESS:  
25~50µm  
SOLDER PLATING: 4~10µm  
FINAL PLATED HOLE DIA.:  
#0.6±0.05mm

注文コード Ordering Code

Type C	27	8071	055	XXX	XXX+
Type CR	27	8071	055	XXX	XXX D+

**VARIATION**

- 001 : 55P (キー付シールド無、ボス有り) (with coding key, without shield, with boss)
- 002 : 55P (キー付シールド無、ボス無し) (with coding key, without shield, without boss)
- 011 : 55P (キー付シールド有り、ボス有り) (with coding key, with shield, with boss)
- 012 : 55P (キー付シールド有り、ボス無し) (with coding key, with shield, without boss)

**FINISH CODE**

- 840 : Au0.38µm
- 863 : Au0.76µm
- 833 : Pd/Ni0.65

Bottom Shield

TYPE C, CR

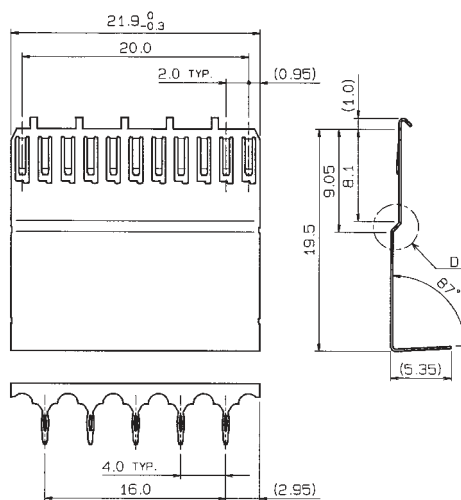

Example

Without Bottom Shield

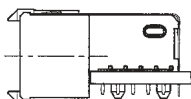

With Bottom Shield

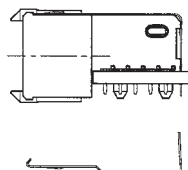

注文コード Ordering Code

82	8071	XXX	500	XXX+
----	------	-----	-----	------

**NUMBER OF CONTACTS**

- 055 : 55P 55signal

**FINISH CODE**

- 840 : Au0.38µm
- 863 : Au0.76µm
- 833 : Pd/Ni0.65

# MULTI LINE MODULE CONNECTORS

SERIES

# 8071

## プラグ シュラウド TYPE A, TYPE B

### Plug Shroud

### Back Planes

TYPE A

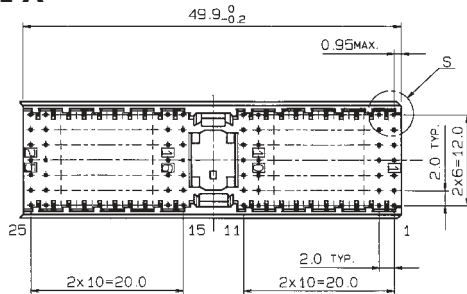

バリエーションコード VARIATION CODE	L	H	基板厚 PCB THICKNESS
301	3.0	13.45	t=4.8mm
311	3.8	14.25	t=4.0mm
321	4.6	15.05	t=3.2mm

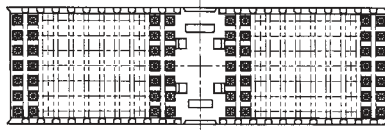
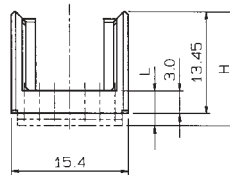
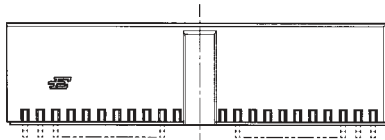

#### 注文コード Ordering Code

61 8071 154 XXX 007

#### VARIATION

- 301 : TYPE A キー付基板厚 4.8mm用  
(with coding key, Base Thickness 4.8mm)
- 311 : TYPE A キー付基板厚 4.0mm用  
(with coding key, Base Thickness 4.0mm)
- 321 : TYPE A キー付基板厚 3.2mm用  
(with coding key, Base Thickness 3.2mm)

### Back Planes

TYPE B

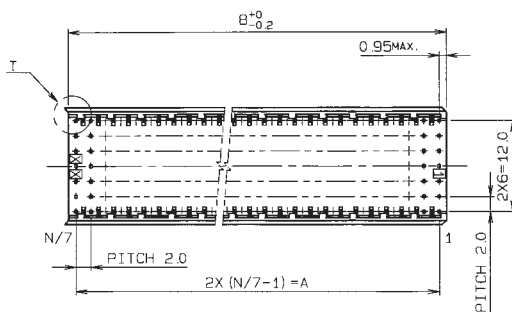

P/N	A	B	CIRCUIT END NO.
61 8071 123 XXX 007	36.0	37.9	19
61 8071 154 XXX 007	42.0	43.9	22
61 8071 175 XXX 007	48.0	49.9	25

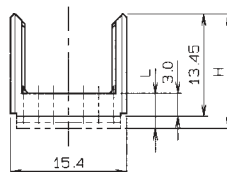
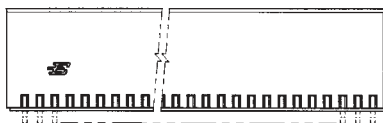

#### 注文コード Ordering Code

61 8071 XXX XXX 007

#### NUMBER OF CONTACTS

- 133 : 133P 95signal+38ground
- 154 : 154P 110signal+44ground
- 175 : 175P 125signal+50ground

#### VARIATION

- 300 : TYPE B キー無基板厚 4.8mm用  
(without coding key, Base Thickness 4.8mm)
- 310 : TYPE B キー無基板厚 4.0mm用  
(without coding key, Base Thickness 4.0mm)
- 320 : TYPE B キー無基板厚 3.2mm用  
(without coding key, Base Thickness 3.2mm)



# MULTI LINE MODULE CONNECTORS

SERIES

# 8071

プラグ シュラウド TYPE C, TYPE CR, TYPE AB  
Plug Shroud

## Back Planes TYPE C, CR

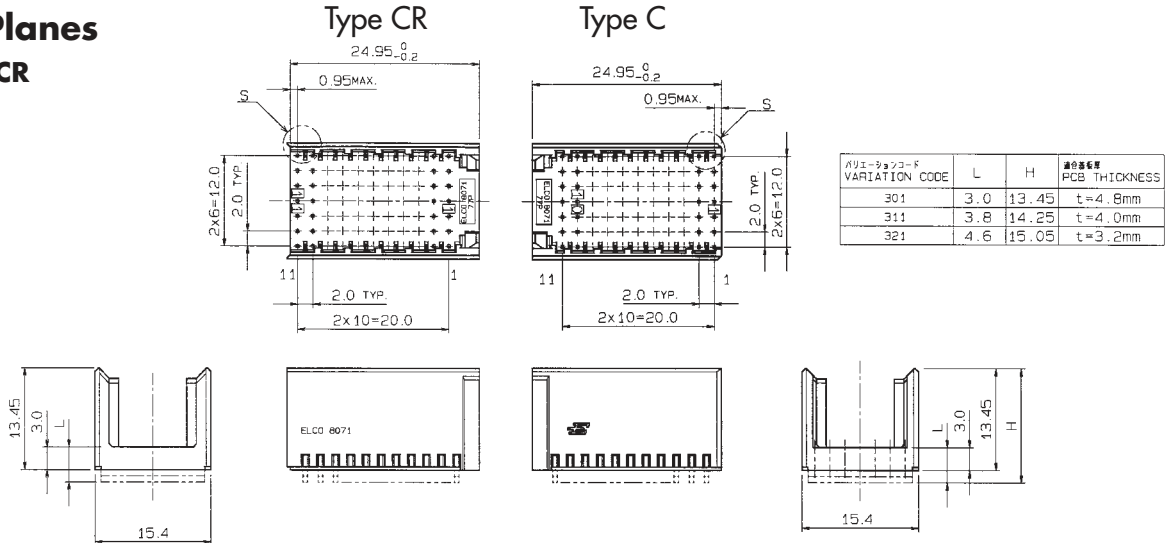

### 注文コード Ordering Code

Type C 61 8071 077 XXX 007  
Type CR 61 8071 077 XXX 007 D

#### VARIATION

301 : TYPE C, D キー付基板厚 4.8mm用  
(with coding key, Base Thickness 4.8mm)  
311 : TYPE C, D キー付基板厚 4.0mm用  
(with coding key, Base Thickness 4.0mm)  
321 : TYPE C, D キー付基板厚 3.2mm用  
(with coding key, Base Thickness 3.2mm)

## Back Planes TYPE AB

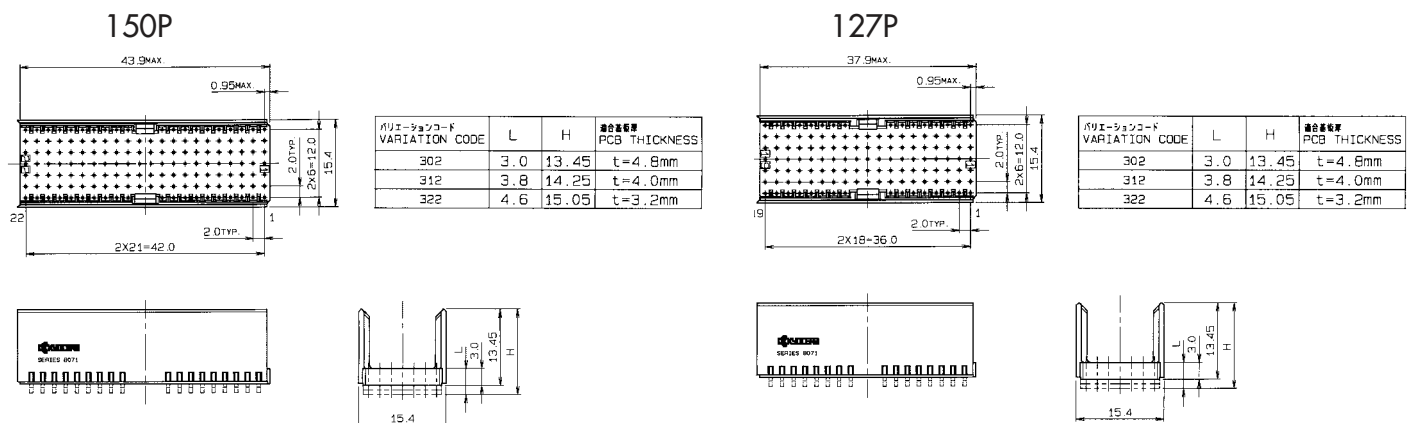

### 注文コード Ordering Code

61 8071 XXX 3X2 007

#### NUMBER OF CONTACTS

150 : 150P  
127 : 127P

#### VARIATION

302 : TYPE AB 基板厚 4.8mm用  
(Base Thickness 4.8mm)  
312 : TYPE AB 基板厚 4.0mm用  
(Base Thickness 4.0mm)  
322 : TYPE AB 基板厚 3.2mm用  
(Base Thickness 3.2mm)

# MULTI LINE MODULE CONNECTORS

SERIES

# 8071

プラグ ストレート/リセプタクル ライトアングル  
**TYPE AB**  
 Plug Straight/Receptacle Right Angle

## Back Planes

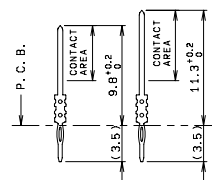
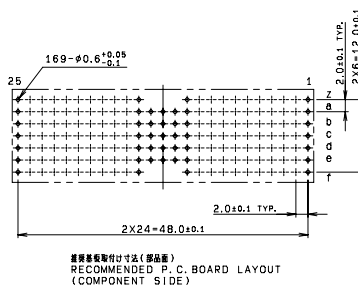
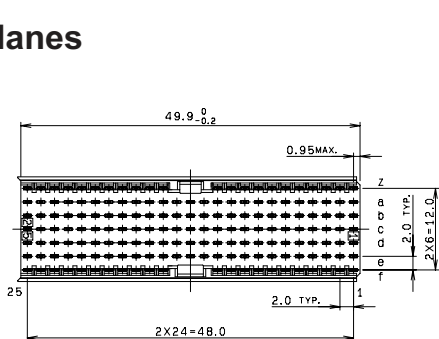

推奨基板取付け寸法 (部品番)  
 RECOMMENDED P.C. BOARD LAYOUT  
 (COMPONENT SIDE)

1. ピン配置 (コネクタ接合面側)  
 CONTACTS LAYOUT  
 (CONNECTOR MATING SIDE SHOWN)



①  
 レベル-2  
 LEVEL-2

②  
 レベル-3  
 LEVEL-3

CONTACT 寸法  
 CONTACT DETAIL

2. 適用基板仕様 APPLICABLE P.C. BOARD  
 基板厚 P.C. BOARD THICKNESS:  
 t=1.4~5.0mm  
 穴径仕様 APPLICABLE T/H  
 下穴径 PREPARED HOLE DIA.:  
 φ0.7±0.025mm  
 銅めっき厚 COPPER PLATING THICKNESS:  
 25~50µm  
 (はんだめっき SOLDER PLATING: 4~10µm)  
 仕上げ径 FINAL PLATED HOLE DIA.:  
 φ0.6±0.05  
 φ0.6±0.1

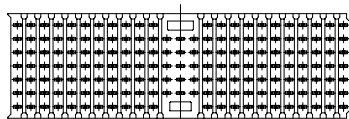
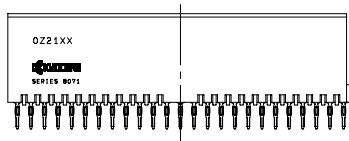

### 注文コード Ordering Code

17 8071 169 512 XXX+

#### FINISH CODE

840 : Au0.38µm  
 863 : Au0.76µm  
 833 : Pd/Ni0.65

## Daughter Card

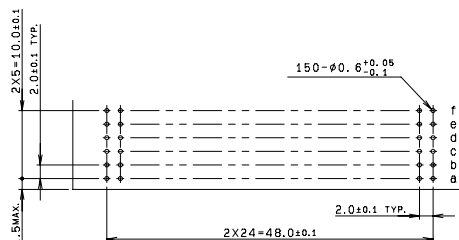
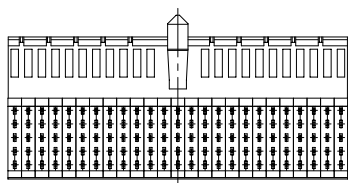
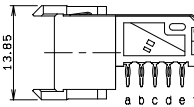
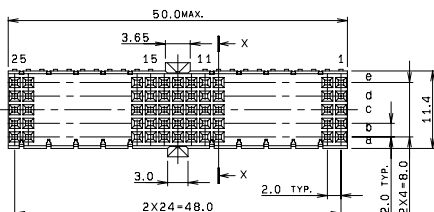
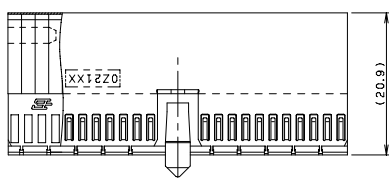

推奨基板取付け寸法 (部品番)  
 RECOMMENDED P.C. BOARD LAYOUT  
 (COMPONENT SIDE)

1. D列には下記を示すプラグコンタクトは挿入不可。  
 THOSE PLUG CONTACTS AS SHOWN BELOW  
 ARE NOT PERMITTED TO INSERT ON ROW-D.  
 フロント面側: レベル-3, K, N, U  
 バック面側: レベル-T, U, W  
 FRONT SIDE: LEVEL-3, K, N, U  
 BACK SIDE: LEVEL-T, U, W

2. 適用基板仕様 APPLICABLE P.C. BOARD  
 基板厚 P.C. BOARD THICKNESS:  
 t=1.4~4.2mm  
 穴径仕様 APPLICABLE T/H  
 下穴径 PREPARED HOLE DIA.:  
 φ0.7±0.025mm  
 銅めっき厚 COPPER PLATING THICKNESS:  
 25~50µm  
 (はんだめっき SOLDER PLATING: 4~10µm)  
 仕上げ径 FINAL PLATED HOLE DIA.:  
 φ0.6±0.05  
 φ0.6±0.1

### 注文コード Ordering Code

27 8071 125 013 XXX+

#### FINISH CODE

840 : Au0.38µm  
 863 : Au0.76µm  
 833 : Pd/Ni0.65

# MULTI LINE MODULE CONNECTORS

SERIES

# 8071

## コーディングキー Coding Key

### ■ Plug

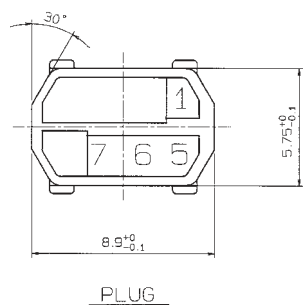
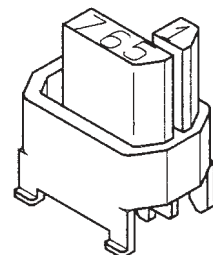
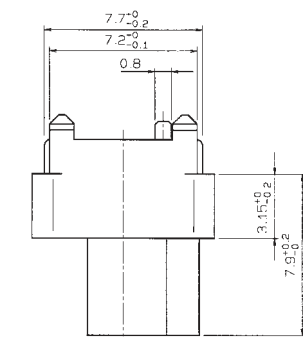

### 注文コード Ordering Code

81 8071 000 XXX XXX

キーコードNo. KEY CODE No.	101 003	102 006	103 008	104 002
色相 COLOR	カドミウムイエロー CADMIUM YELLOW	ブリリアント ブルー BRILLIANT BLUE	パステルオレンジ PASTEL ORANGE	ストロベリーレッド STRAWBERRY RED
キーブロック配置 KEY BLOCK LAYOUT				

### ■ Receptacle

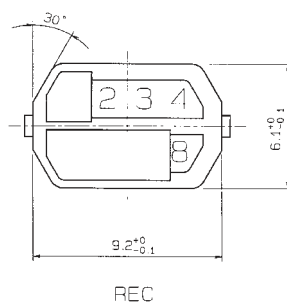
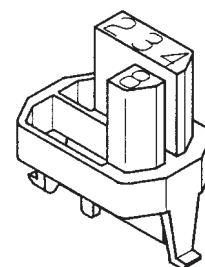
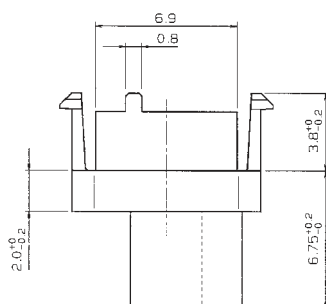

### 注文コード Ordering Code

82 8071 000 XXX XXX

キーコードNo. KEY CODE No.	101 003	102 006	103 008	104 002
色相 COLOR	カドミウムイエロー CADMIUM YELLOW	ブリリアント ブルー BRILLIANT BLUE	パステルオレンジ PASTEL ORANGE	ストロベリーレッド STRAWBERRY RED
キーブロック配置 KEY BLOCK LAYOUT				

## SERIES 8071 REQUEST GUIDE

### ご案内

8071シリーズプラグコネクタには、長さ別に12種類のピンコンタクトが、用意されています。ユーザーは、用途に応じて選択されたピンコンタクトとその配列をオーダーすることができます。本シートの写しをオーダーシートとして弊社までご用命ください。

- 適用コネクタは、バリエーションA、B及びCタイプに限ります。
- ピンコンタクト配列上の注意点
  - ・ドーターボードに取り付けられたA、B、Cタイプ・リセプタクル・コネクタと嵌合させる場合は、b列にコンタクトコード：3、K、N、Tは、装填できません。
- プラグコネクタ ピン配列オーダー手順
  - ・用途に応じた長さのピンコンタクトをコンタクトバリエーションの表の中から選択し、そのコンタクトコードをP47の必要なコネクタコラムA～Cの中にすべて記入して下さい。
  - ・空きピンを要望される場合は、記入漏れが無いようスラッシュを記入して下さい。

### NOTES

In case of you mate a Receptacle Connector of A, B, C type on your daughter board, we could not support to insert contact (contact code 3, K, N, T) in B row.

If you need a specially loaded configuration for your application, please use this form. Fill out the grid diagram for the connector style you desire (A, B, C) and mark which pin (3,2,1,K,L,M,N,P,S,T,U,W) is required in each position. If you want blank position connector, please write (/) on this sheets.

### ピンコンタクトオーダー記入例

#### EXAMPLE OF PIN CONTACT ORDER (154P WITH POLARIZING KEY)

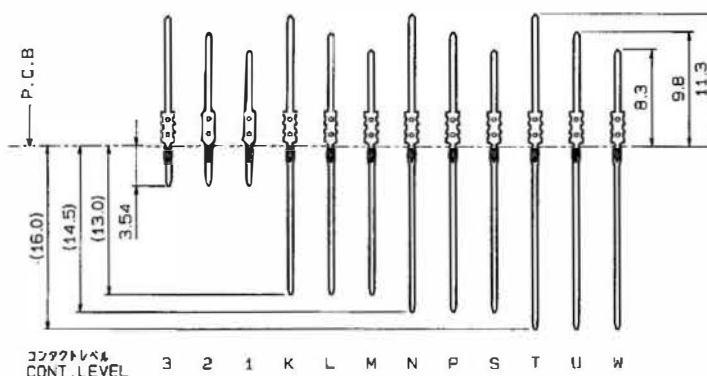
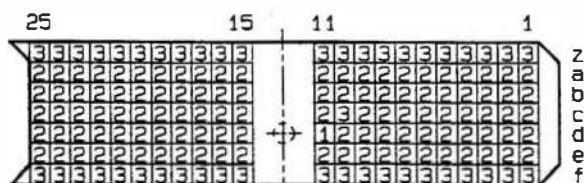

\*コネクタコラム A、B、Cは、すべてコネクタのフロント面側を示します。

\*This column display the front connector side.

# Request Sheet

b列について：リセプタクル側がライトアングルの場合、プラグコンタクトの長さに規制が出ます。

リセ側ライトアングルの場合：b列・1、2、L、M、P、S、U、W（3、K、N、Tは使用できません）

リセ側ストレートの場合：b列・1、2、3、K、L、M、N、P、S、T、U、W（全て使用できます）

Row b: When the receptacle connector is right angle type, the length of contacts of the plug connector shall be restricted.

When the receptacle is right angle type, pins in Row b of the plug connector shall be 1, 2, L, M, P, S, U and W. (3, K, N, and T are not usable.)

When the receptacle is Vertical type, all of (1, 2, 3, K, L, M, N, P, S, T, U and W) are usable for pins in Row b of the plug connector.

## Connector Column A

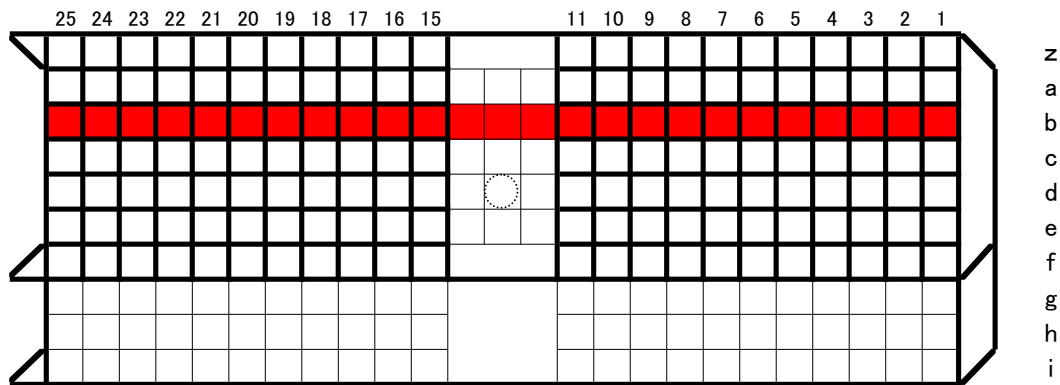

## Connector Column B

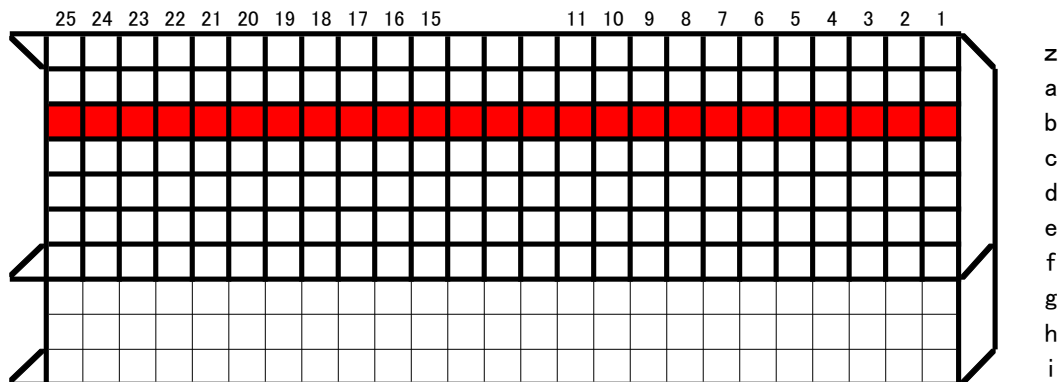

## Connector Column C

77P With Polarizing Key

