

## TMAG511x 2D, Dual-Channel, High-Sensitivity, Hall-Effect Latch

### 1 Features

- 2D sensing with planar and vertical hall sensors
- Inherent quadrature independent of magnet alignment or magnet pole pitch
- Two functional options available:
  - TMAG5110: independent 2D outputs
  - TMAG5111: speed and direction outputs
- Ultra-high magnetic sensitivity:
  - TMAG511xx2:  $\pm 1.4$  mT (typical)
  - TMAG511xx4:  $\pm 3$  mT (typical)
- Fast 40-kHz sensing bandwidth
- 2.5-V to 38-V operating  $V_{CC}$  range
- Open-drain output (10 mA sink)
- Wide ambient operating temperature range:
  - $-40$  °C to  $+125$  °C
- **Protection features**
  - Reverse supply protection (up to  $-20$  V)
  - Device survives up to 40-V
  - Output short-circuit protection
  - Output current limitation

### 2 Applications

- Incremental rotary encoding
- Linear speed and direction control
  - Motorized window blinds and shades
  - Motorized garage door
- Angular position detection
  - Knob control
  - Fluid measurement
- Angular speed and direction
  - [Electric pumps](#)
  - [Fans](#)
  - Wheel and motor speed

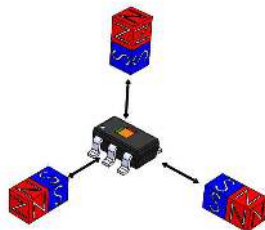

Device Axis Polarities

### 3 Description

The TMAG5110 and TMAG5111 are 2-dimensional, dual Hall-effect latches operating from a 2.5 V to 38 V power supply. Designed for high-speed and high-temperature motor applications, these devices are optimized for applications leveraging rotating magnets. Integrating two sensors and two separate signal chains the TMAG511x offers two independent digital outputs giving speed and direction calculation (TMAG5111) or giving directly the digital output of each independent latches (TMAG5110). This high level of integration allow the use of a single TMAG511x device instead of two separate latches.

The device is offered in a standard 3 mT operating point, as well as a high-sensitivity 1.4 mT operating point. The higher magnetic sensitivity provides flexibility in low-cost magnet selection and mechanical component placement. The TMAG511x is also available in three 2-axis combination options (X-Y, Z-X, Z-Y) to allow flexible placement of the sensor relative to the magnet.

The device performs consistently across a wide ambient temperature range of  $-40$  °C to  $+125$  °C.

#### Device Information

PART NUMBER	PACKAGE <sup>(1)</sup>	BODY SIZE (NOM)
TMAG5110	SOT-23 (5)	2.9 mm × 1.6 mm
TMAG5111		

- (1) For all available packages, see the package option addendum at the end of the data sheet.

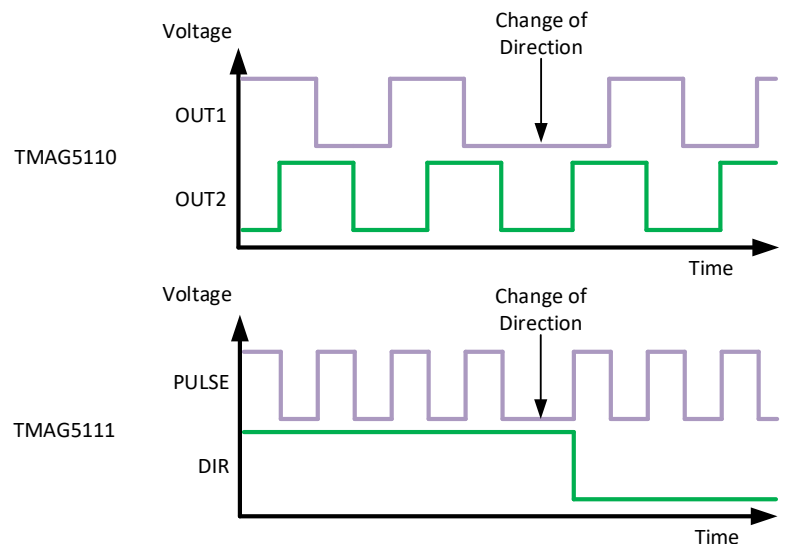

Device Outputs



## Table of Contents

<b>1 Features</b> .....	1	8.3 Feature Description.....	21
<b>2 Applications</b> .....	1	8.4 Device Functional Modes.....	30
<b>3 Description</b> .....	1	<b>9 Application and Implementation</b> .....	31
<b>4 Revision History</b> .....	2	9.1 Application Information.....	31
<b>5 Device Comparison</b> .....	3	9.2 Typical Applications.....	31
<b>6 Pin Configuration and Functions</b> .....	4	<b>10 Power Supply Recommendations</b> .....	33
<b>7 Specifications</b> .....	5	<b>11 Layout</b> .....	33
7.1 Absolute Maximum Ratings .....	5	11.1 Layout Guidelines.....	33
7.2 ESD Ratings .....	5	11.2 Layout Example.....	33
7.3 Recommended Operating Conditions .....	5	<b>12 Device and Documentation Support</b> .....	34
7.4 Thermal Information .....	5	12.1 Receiving Notification of Documentation Updates.....	34
7.5 Electrical Characteristics .....	6	12.2 Support Resources.....	34
7.6 Magnetic Characteristics .....	6	12.3 Trademarks.....	34
7.7 Typical Characteristics.....	7	12.4 Electrostatic Discharge Caution.....	34
<b>8 Detailed Description</b> .....	21	12.5 Glossary.....	34
8.1 Overview.....	21	<b>13 Mechanical, Packaging, and Orderable Information</b> .....	34
8.2 Functional Block Diagram.....	21		

## 4 Revision History

Changes from Revision C (September 2021) to Revision D (June 2022)	Page
• Changed <i>Layout Example</i> .....	33

Changes from Revision B (March 2021) to Revision C (September 2021)	Page
• Removed the remaining preview notes from the <i>Device Comparison</i> table.....	3
• Added operating supply current for the TMAG511xx4 .....	6
• Added graphs to the <i>Typical Characteristics</i> section.....	7

Changes from Revision A (February 2021) to Revision B (March 2021)	Page
• Changed TMAG5111 device status from Advanced Information to Production Data.....	1
• Removed the preview notes on the TMAG511x 1.4mT orderables in the <i>Device Comparison</i> table.....	3
• Added note on the TMAG5111 power-on behavior to the <i>Power-On Time</i> section.....	26

Changes from Revision * (December 2020) to Revision A (February 2021)	Page
• Removed the preview note on the TMAG5110C2 orderable in the <i>Device Comparison</i> table.....	3

## 5 Device Comparison

**Table 5-1. Device Comparison**

DEVICE	DEVICE OPTION	SENSITIVITY (BOP TYP)	AXIS OF SENSITIVITY	OUT1	OUT2
TMAG5110	A2	1.4 mT	XY	X	Y
	A4	3 mT			
	B2	1.4 mT	ZX	Z	X
	B4	3 mT			
	C2	1.4 mT	ZY	Z	Y
	C4	3 mT			
TMAG5111	A2	1.4 mT	XY	Speed	Direction
	A4	3 mT			
	B2	1.4 mT	ZX		
	B4	3 mT			
	C2	1.4 mT	ZY		
	C4	3 mT			

## 6 Pin Configuration and Functions

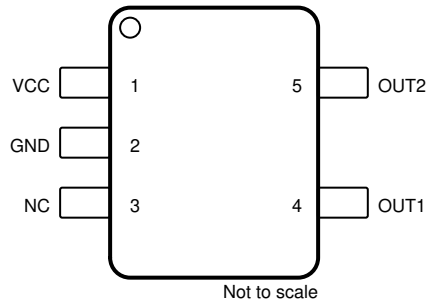

**Figure 6-1. DBV Package 5-Pin SOT-23 Top View**

**Table 6-1. Pin Functions**

PIN		TYPE	DESCRIPTION
NO.	NAME		
1	V <sub>CC</sub>	Power supply	2.5-V to 38-V power supply. Connect a ceramic capacitor with a value of at least 0.01 μF between V <sub>CC</sub> and ground.
2	GND	Ground	Ground reference.
3	NC	—	Not internally connected. Connection to the ground pin is recommended.
4	OUT1	Output	Open-drain output 1. For TMAG5110A: X axis. For TMAG5110B: Z axis. For TMAG5110C: Z axis. For TMAG5111: Speed.
5	OUT2	Output	Open-drain output 2. For TMAG5110A: Y axis. For TMAG5110B: X axis. For TMAG5110C: Y axis. For TMAG5111: Direction.

## 7 Specifications

### 7.1 Absolute Maximum Ratings

over operating free-air temperature range (unless otherwise noted)<sup>(1)</sup>

		MIN	MAX	UNIT
Power Supply Voltage	V <sub>CC</sub>	-20	40	V
	Voltage ramp rate (V <sub>CC</sub> < 5V)	Unlimited		V/μs
	Voltage ramp rate (V <sub>CC</sub> > 5V)	0	2	
Output Pin Voltage	V <sub>OUT1</sub> , V <sub>OUT2</sub>	GND – 0.5	40	V
Output pin reverse current during reverse supply condition		0	100	mA
Magnetic flux density, B <sub>MAX</sub>		Unlimited		T
Junction temperature, T <sub>J</sub>		-40	150	°C
Storage temperature, T <sub>stg</sub>		-65	150	°C

- (1) Stresses beyond those listed under *Absolute Maximum Rating* may cause permanent damage to the device. These are stress ratings only, which do not imply functional operation of the device at these or any other conditions beyond those indicated under *Recommended Operating Condition*. Exposure to absolute-maximum-rated conditions for extended periods may affect device reliability.

### 7.2 ESD Ratings

			VALUE	UNIT
V <sub>(ESD)</sub>	Electrostatic discharge	Human body model (HBM), per ANSI/ESDA/JEDEC JS-001, all pins <sup>(1)</sup>	±2000	V
		Charged device model (CDM), per JEDEC specification JESD22-C101, all pins <sup>(2)</sup>	±500	

- (1) JEDEC document JEP155 states that 500-V HBM allows safe manufacturing with a standard ESD control process.  
(2) JEDEC document JEP157 states that 250-V CDM allows safe manufacturing with a standard ESD control process.

### 7.3 Recommended Operating Conditions

over operating free-air temperature range (unless otherwise noted)

		MIN	MAX	UNIT
V <sub>CC</sub>	Power supply voltage	2.5	38	V
V <sub>O</sub>	Output pin voltage (OUT1, OUT2)	0	38	V
I <sub>SINK</sub>	Output pin current sink (OUT1, OUT2) <sup>(1)</sup>	0	10	mA
T <sub>A</sub>	Ambient temperature	-40	125	°C

- (1) Power dissipation and thermal limits must be observed

### 7.4 Thermal Information

THERMAL METRIC <sup>(1)</sup>		TMAG5110	UNIT
		DBV (SOT-23)	
		5 PINS	
R <sub>θJA</sub>	Junction-to-ambient thermal resistance	166.5	°C/W
R <sub>θJC(top)</sub>	Junction-to-case (top) thermal resistance	86.0	
R <sub>θJB</sub>	Junction-to-board thermal resistance	37.6	
Ψ <sub>JT</sub>	Junction-to-top characterization parameter	14.1	
Ψ <sub>JB</sub>	Junction-to-board characterization parameter	37.3	
R <sub>θJC(bot)</sub>	Junction-to-case (bottom) thermal resistance	—	°C/W

- (1) For more information about traditional and new thermal metrics, see the [Semiconductor and IC Package Thermal Metrics](#) application report.

## 7.5 Electrical Characteristics

over operating free-air temperature range (unless otherwise noted)

PARAMETER		TEST CONDITIONS	MIN	TYP	MAX	UNIT
<b>POWER SUPPLY</b>						
$I_{CC}$	Operating supply current for TMAG511xx2	$V_{CC} = 2.5\text{ V to }38\text{ V}$ , $T_A = -40^\circ\text{C to }125^\circ\text{C}$		6	8	mA
$I_{CC}$	Operating supply current for TMAG511xx4	$V_{CC} = 2.5\text{ V to }38\text{ V}$ , $T_A = -40^\circ\text{C to }125^\circ\text{C}$		6	8.5	mA
$I_{RCC}$	Reverse-battery current	$V_{CC} = -20\text{ V}$	-100			$\mu\text{A}$
$t_{ON}$	Power-on-time			52.5		$\mu\text{s}$
<b>OUTPUT</b>						
$V_{OL}$	Low-level output voltage	$I_{OL} = 10\text{mA}$	0		0.5	V
$I_{OH}$	Output leakage current	$V_{CC} = 5\text{V}$		0.1	1	$\mu\text{A}$
$I_{SC}$	Output short-circuit current			65	110	mA
$t_{PD}$	Propagation delay time	Change in $B_{OP}$ or $B_{RP}$ to change in output		12.5		$\mu\text{s}$
$t_R$	Output rise time	$R_L = 1\text{k}\Omega$ , $C_L = 50\text{pF}$		0.2		
$t_F$	Output fall time	$R_L = 1\text{k}\Omega$ , $C_L = 50\text{pF}$		0.2		
<b>FREQUENCY RESPONSE</b>						
$f_{CHOP}$	Chopping frequency			320		kHz
$f_{BW}$	Signal bandwidth			40		kHz

## 7.6 Magnetic Characteristics

over operating free-air temperature range (unless otherwise noted)

PARAMETER		TEST CONDITIONS	MIN	TYP	MAX	UNIT
<b>TMAG5110x2</b>						
$B_{OP(1)}, B_{OP(2)}$	Magnetic field operating point	$V_{CC} = 2.5\text{ V to }38\text{ V}$ , $T_A = -40^\circ\text{C to }125^\circ\text{C}$	0.2	1.4	2.6	mT
$B_{RP(1)}, B_{RP(2)}$	Magnetic field release point		-2.6	-1.4	-0.2	
$B_{HYS(1)}, B_{HYS(2)}$	Magnetic hysteresis $B_{OP} - B_{RP}$		0.9	2.75	4.6	
$B_{SYM(1)}, B_{SYM(2)}$	Symmetry	$B_{OP(1)} + B_{RP(1)}, B_{OP(2)} + B_{RP(2)}$	-2		2	mT
$B_{SYM\_OP}$	Operating point symmetry	$B_{OP(1)} - B_{OP(2)}$	-1.5		1.5	
$B_{SYM\_RP}$	Release point symmetry	$B_{RP(1)} - B_{RP(2)}$	-1.5		1.5	
<b>TMAG5110x4</b>						
$B_{OP(1)}, B_{OP(2)}$	Magnetic field operating point	$V_{CC} = 2.5\text{ V to }38\text{ V}$ , $T_A = -40^\circ\text{C to }125^\circ\text{C}$	0.8	3	5.3	mT
$B_{RP(1)}, B_{RP(2)}$	Magnetic field release point		-5.3	-3	-0.8	
$B_{HYS(1)}, B_{HYS(2)}$	Magnetic hysteresis $B_{OP} - B_{RP}$		3	6	9	
$B_{SYM(1)}, B_{SYM(2)}$	Symmetry	$B_{OP(1)} + B_{RP(1)}, B_{OP(2)} + B_{RP(2)}$	-2		2	mT
$B_{SYM\_OP}$	Operating point symmetry	$B_{OP(1)} - B_{OP(2)}$	-1.5		1.5	
$B_{SYM\_RP}$	Release point symmetry	$B_{RP(1)} - B_{RP(2)}$	-1.5		1.5	

## 7.7 Typical Characteristics

### TMAG511xx2 versions

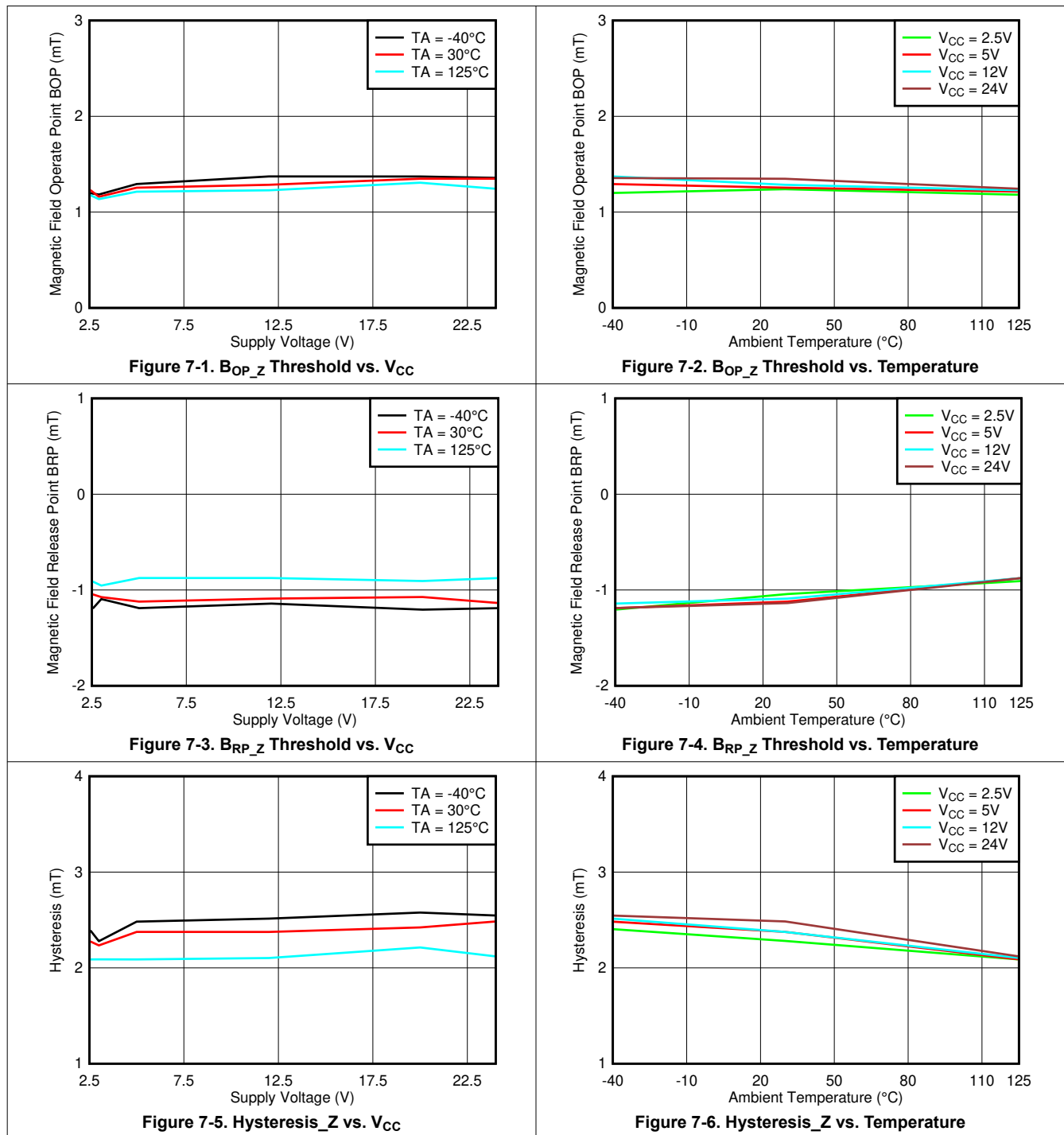

### 7.7 Typical Characteristics (continued)

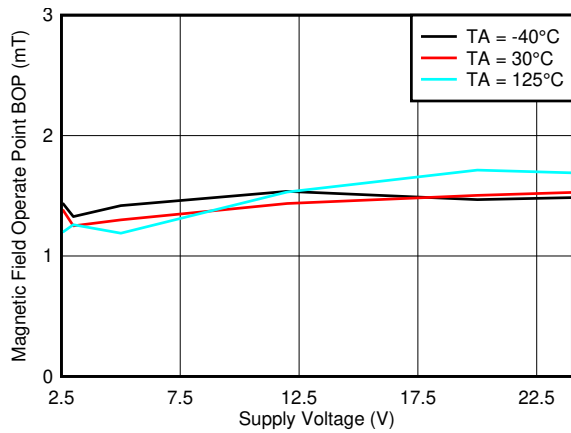

Figure 7-7. BOP\_X Threshold vs. V<sub>CC</sub>

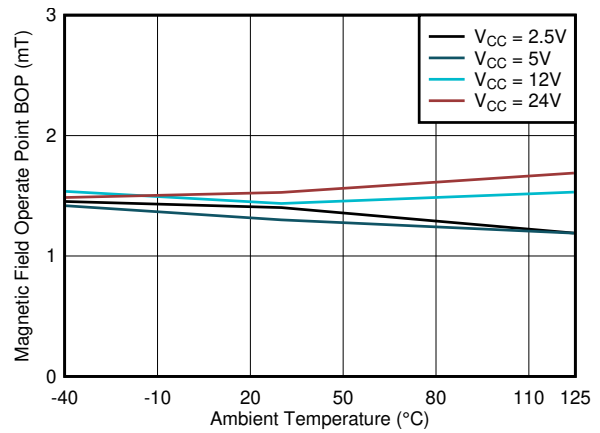

Figure 7-8. BOP\_X Threshold vs. Temperature

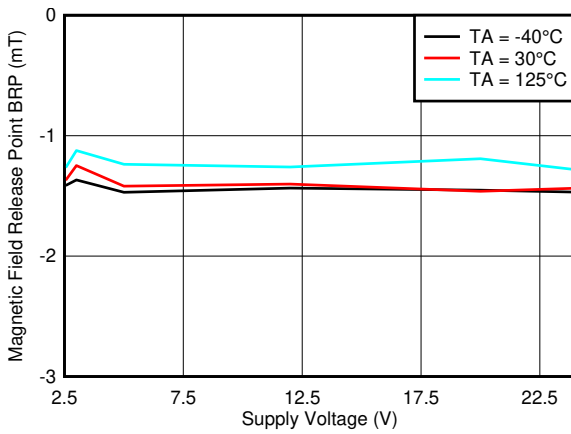

Figure 7-9. BRP\_X Threshold vs. V<sub>CC</sub>

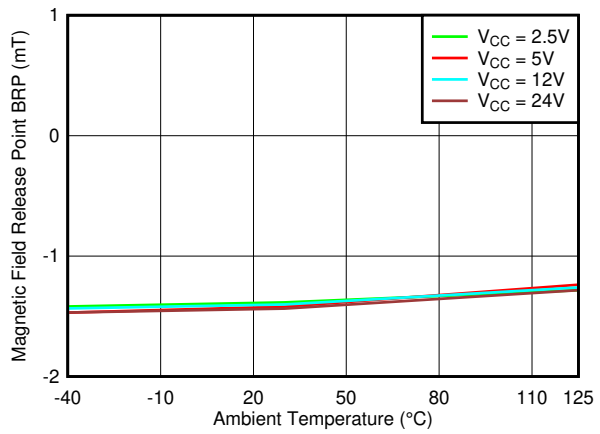

Figure 7-10. BRP\_X Threshold vs. Temperature

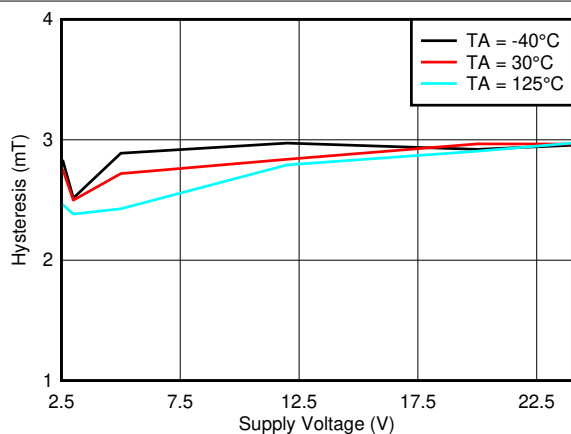

Figure 7-11. Hysteresis\_X vs. V<sub>CC</sub>

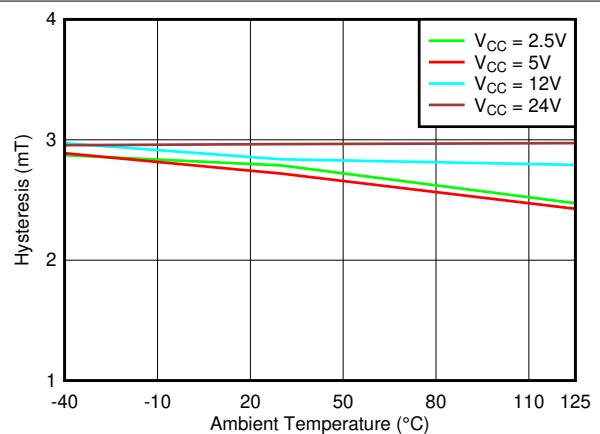
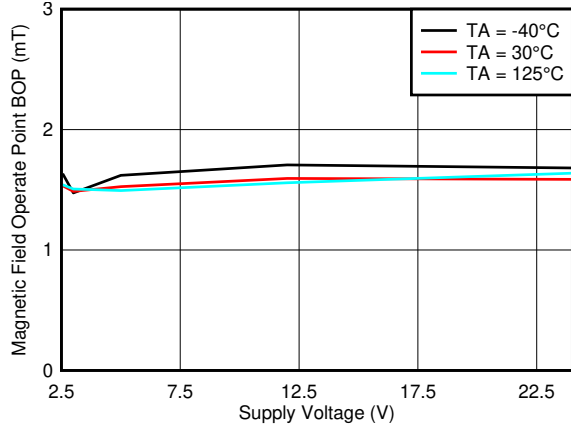

Figure 7-12. Hysteresis\_X vs. Temperature



### 7.7 Typical Characteristics (continued)



**Figure 7-13. B<sub>OP\_Y</sub> Threshold vs. V<sub>CC</sub>**

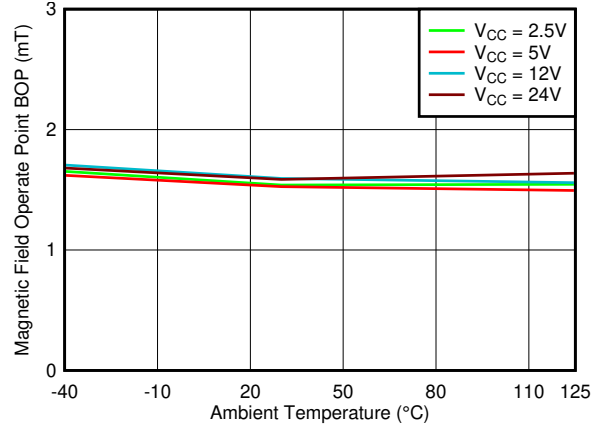

**Figure 7-14. B<sub>OP\_Y</sub> Threshold vs. Temperature**

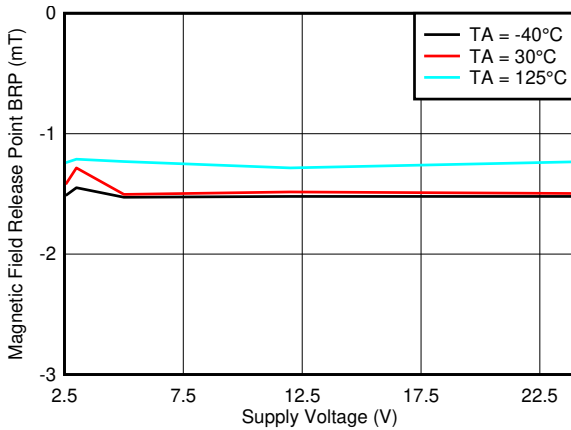

**Figure 7-15. B<sub>RP\_Y</sub> Threshold vs. V<sub>CC</sub>**

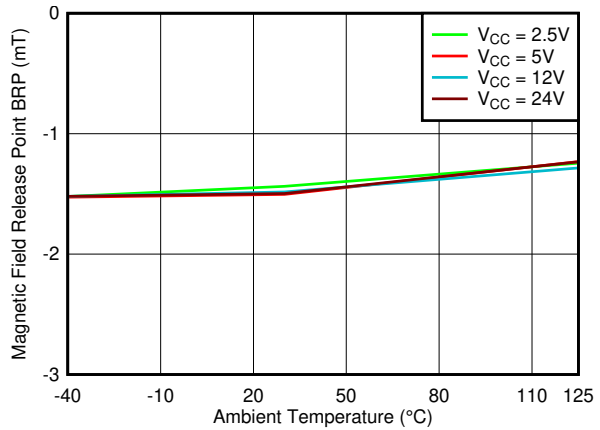

**Figure 7-16. B<sub>RP\_Y</sub> Threshold vs. Temperature**

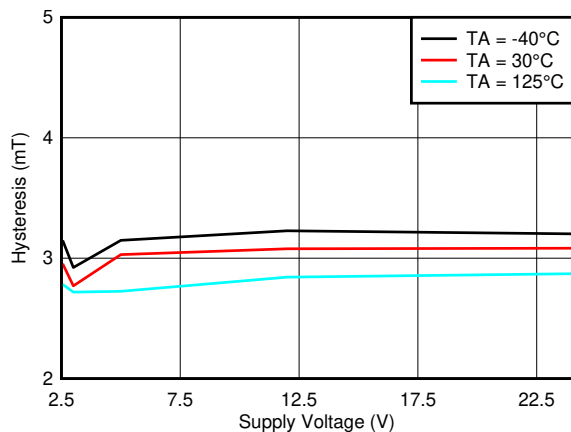

**Figure 7-17. Hysteresis<sub>Y</sub> vs. V<sub>CC</sub>**

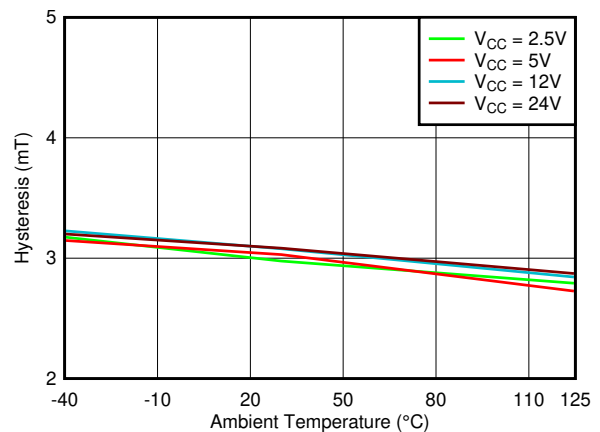

**Figure 7-18. Hysteresis<sub>Y</sub> vs. Temperature**

### 7.7 Typical Characteristics (continued)

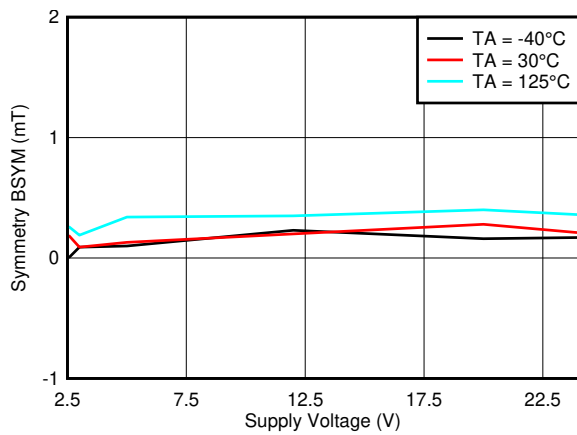

Figure 7-19.  $B_{SYM(Z)}$  vs.  $V_{CC}$

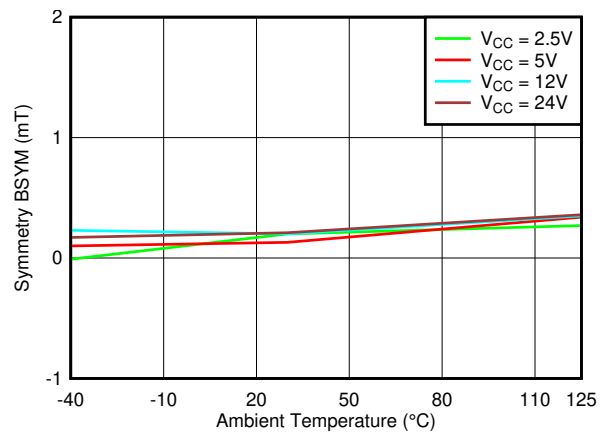

Figure 7-20.  $B_{SYM(Z)}$  vs. Temperature

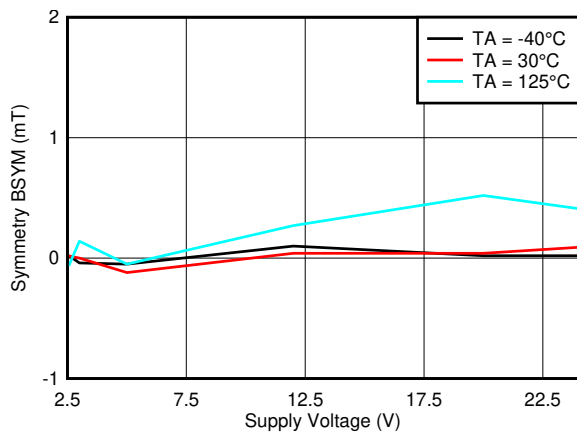

Figure 7-21.  $B_{SYM(X)}$  vs.  $V_{CC}$

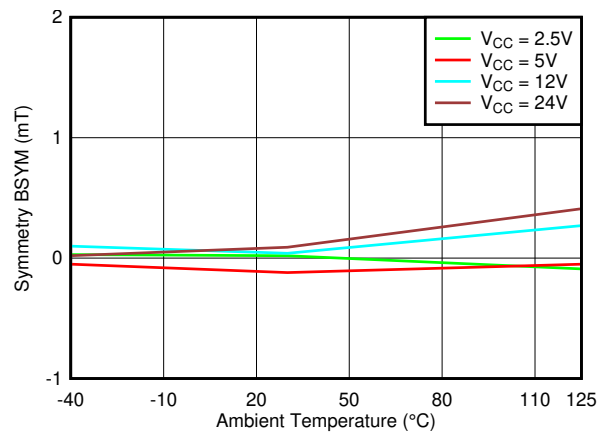

Figure 7-22.  $B_{SYM(X)}$  vs. Temperature

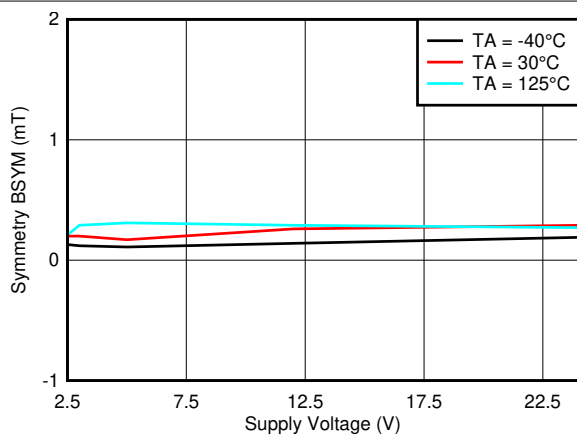

Figure 7-23.  $B_{SYM(Y)}$  vs.  $V_{CC}$

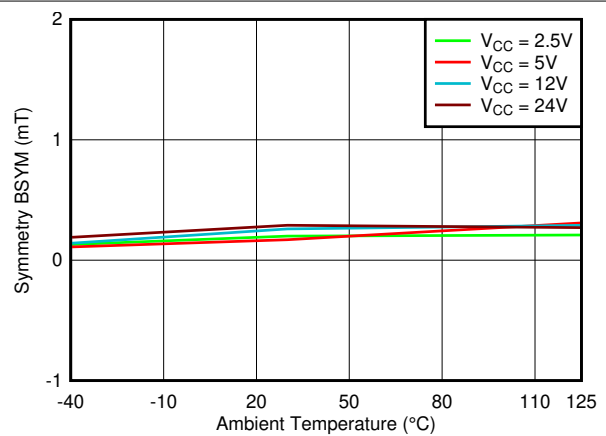

Figure 7-24.  $B_{SYM(Y)}$  vs. Temperature

### 7.7 Typical Characteristics (continued)

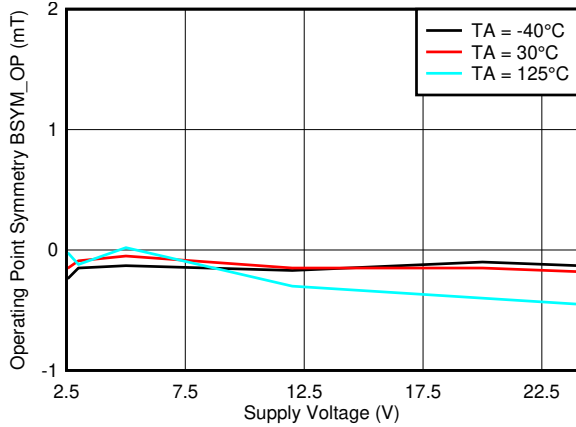

Figure 7-25.  $B_{SYM\_OP(ZX)}$  vs.  $V_{CC}$

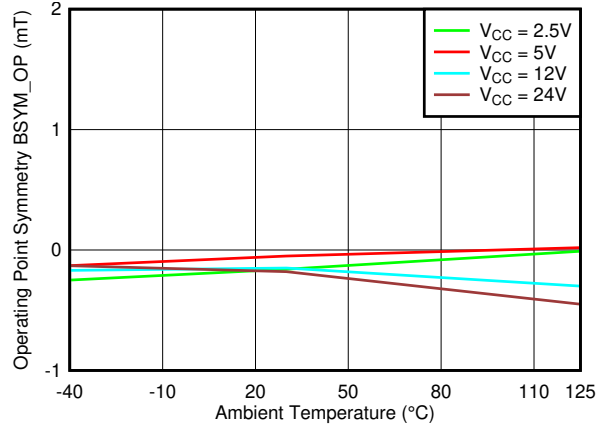

Figure 7-26.  $B_{SYM\_OP(ZX)}$  vs. Temperature

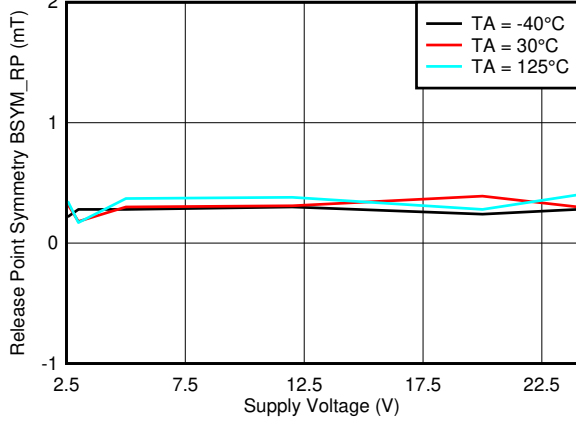

Figure 7-27.  $B_{SYM\_RP(ZX)}$  vs.  $V_{CC}$

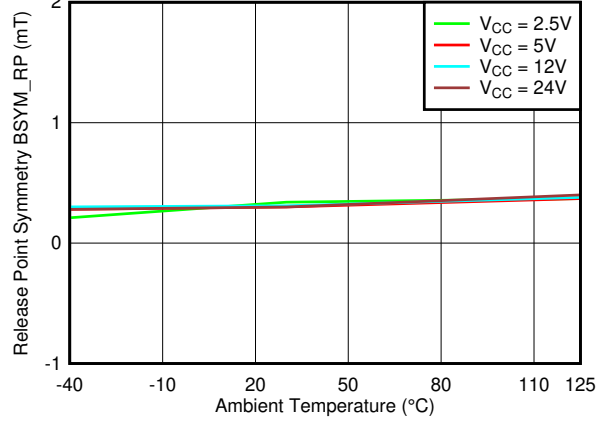

Figure 7-28.  $B_{SYM\_RP(ZX)}$  vs. Temperature

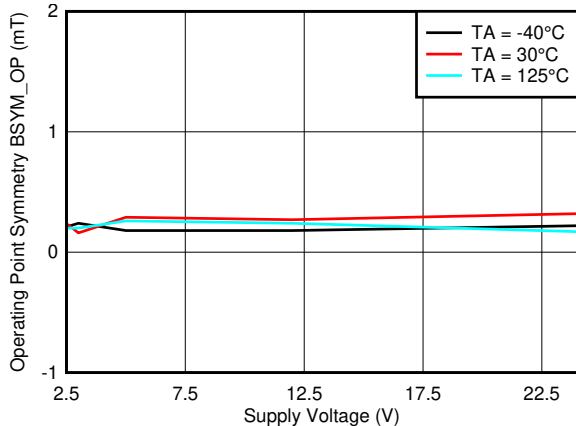

Figure 7-29.  $B_{SYM\_OP(ZY)}$  vs.  $V_{CC}$

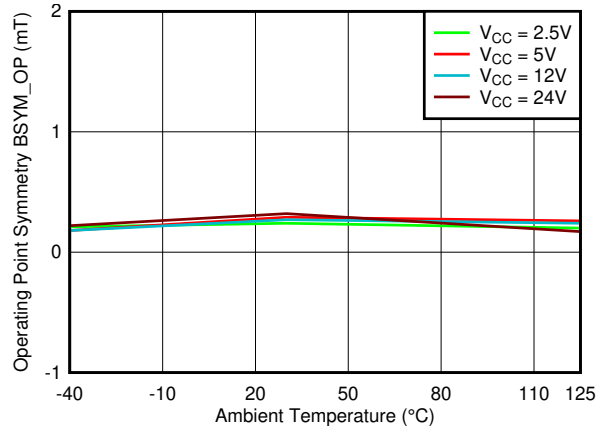

Figure 7-30.  $B_{SYM\_OP(ZY)}$  vs. Temperature

## 7.7 Typical Characteristics

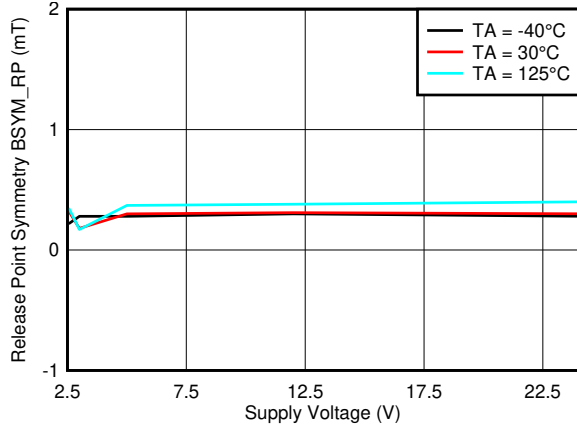

Figure 7-31.  $B_{SYM\_RP(ZY)}$  vs.  $V_{CC}$

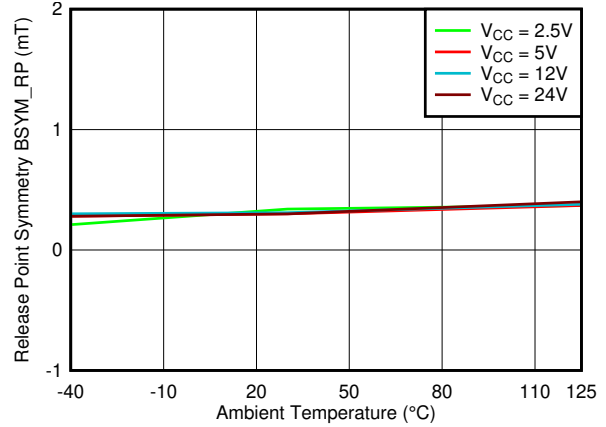

Figure 7-32.  $B_{SYM\_RP(ZY)}$  vs. Temperature

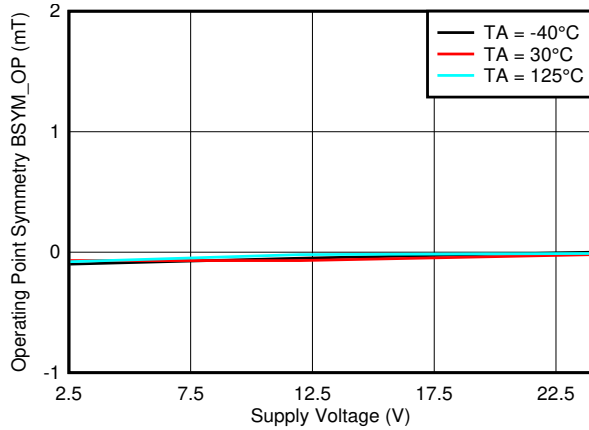

Figure 7-33.  $B_{SYM\_OP(XY)}$  vs.  $V_{CC}$

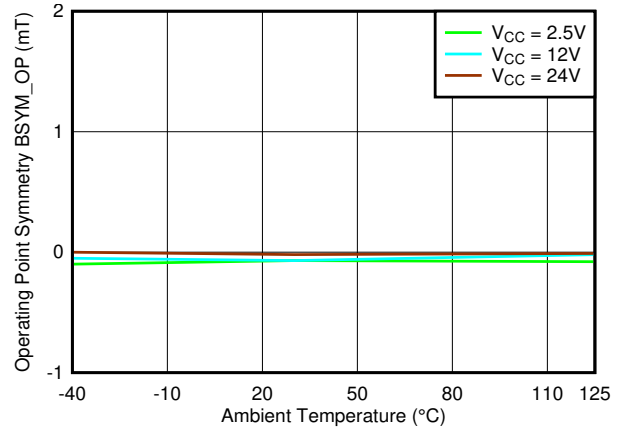

Figure 7-34.  $B_{SYM\_OP(XY)}$  vs. Temperature

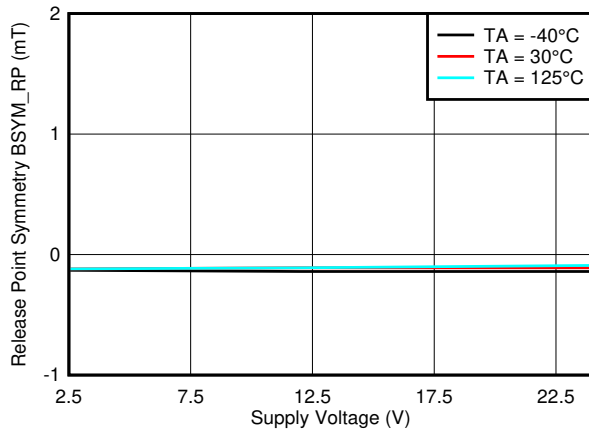

Figure 7-35.  $B_{SYM\_RP(XY)}$  vs.  $V_{CC}$

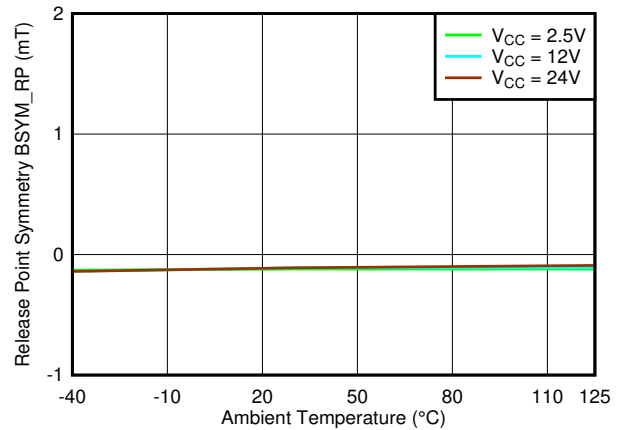
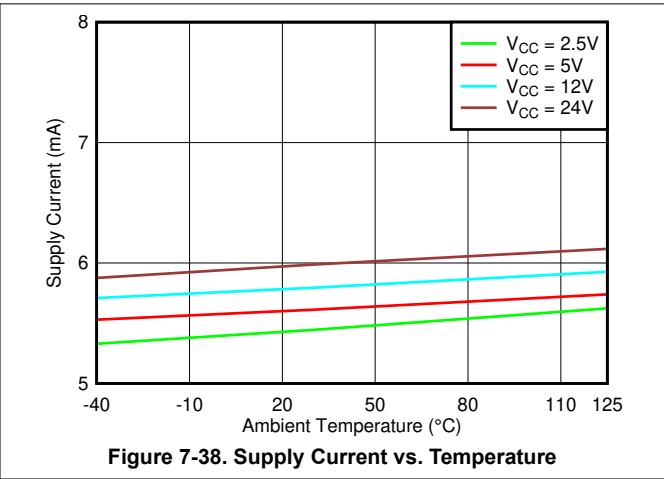
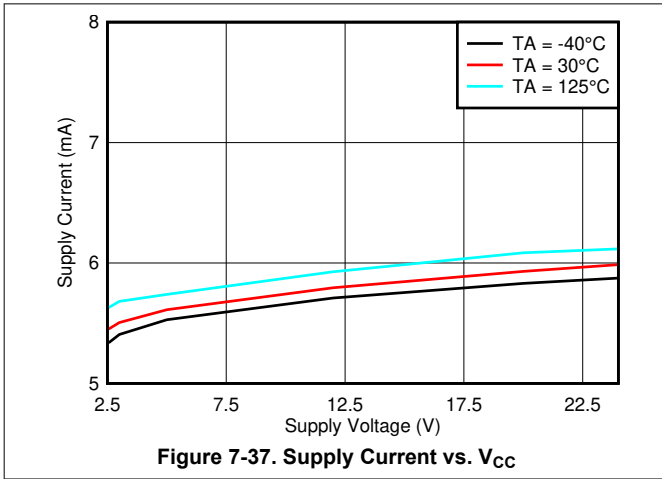

Figure 7-36.  $B_{SYM\_RP(XY)}$  vs. Temperature

### 7.7 Typical Characteristics (continued)



## 7.7 Typical Characteristics

### TMAG511xx4 versions

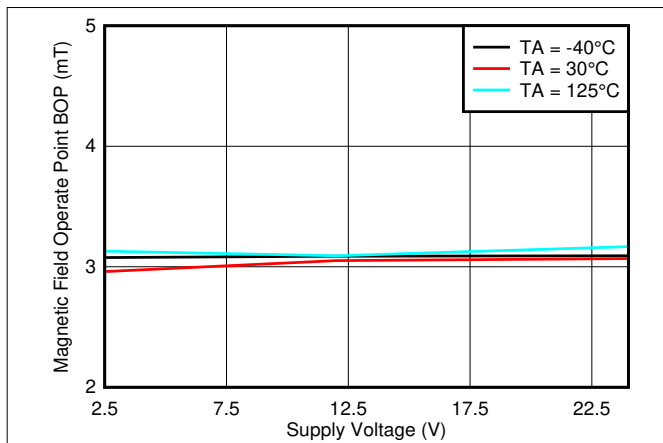

Figure 7-39.  $B_{OP\_Z}$  Threshold vs.  $V_{CC}$

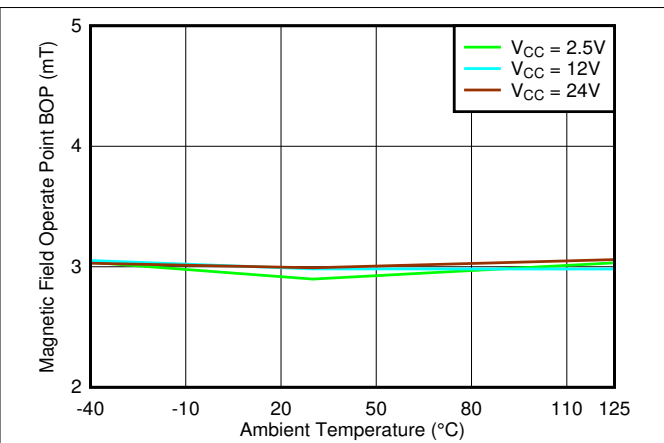

Figure 7-40.  $B_{OP\_Z}$  Threshold vs. Temperature

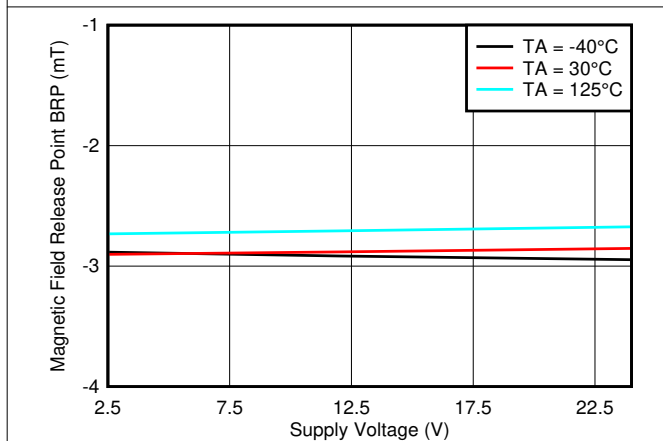

Figure 7-41.  $B_{RP\_Z}$  Threshold vs.  $V_{CC}$

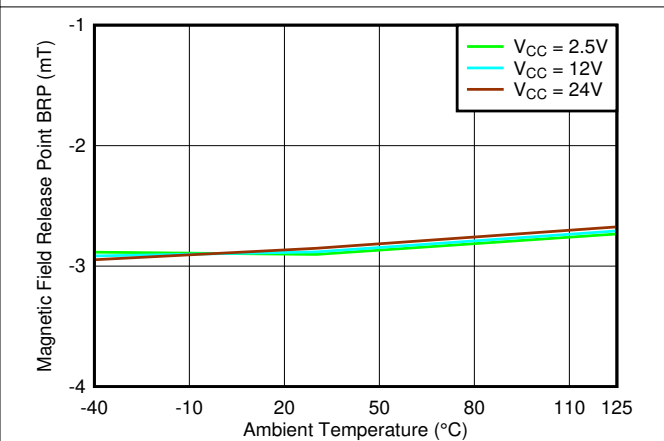

Figure 7-42.  $B_{RP\_Z}$  Threshold vs. Temperature

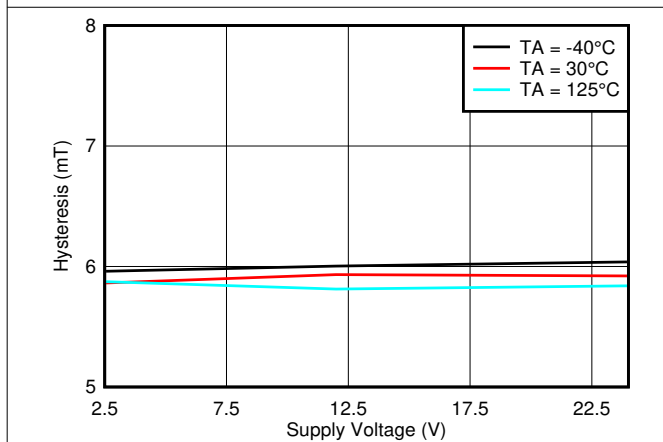

Figure 7-43. Hysteresis<sub>Z</sub> vs.  $V_{CC}$

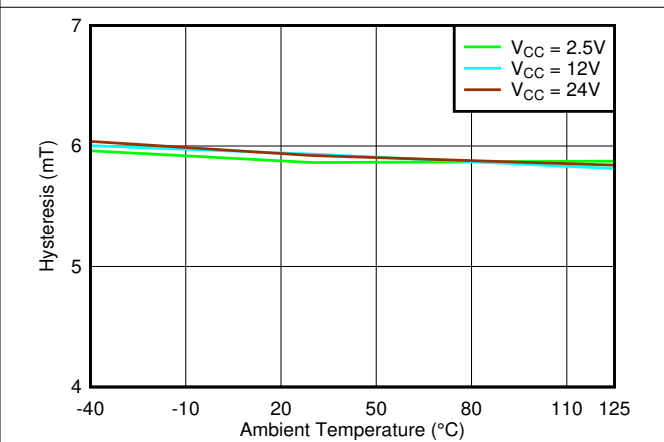
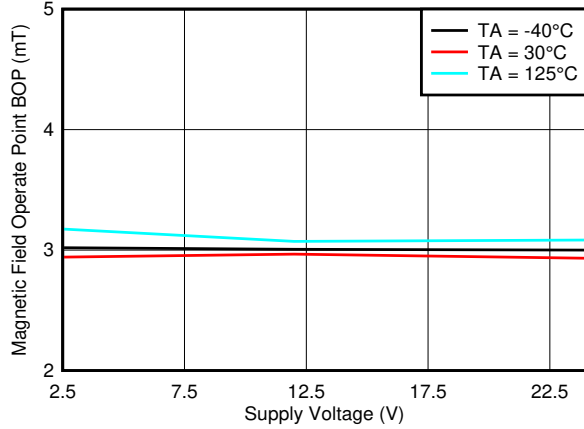
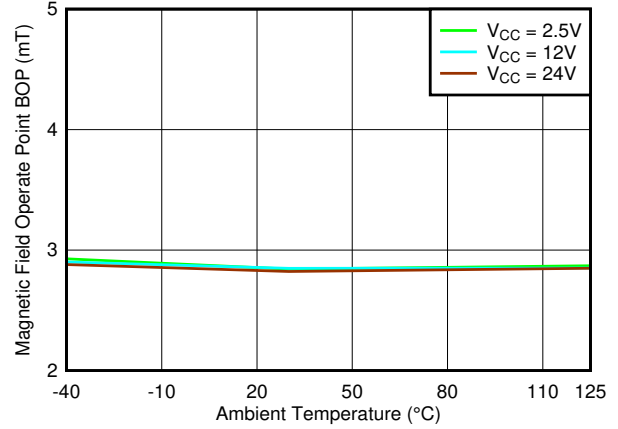

Figure 7-44. Hysteresis<sub>Z</sub> vs. Temperature

### 7.7 Typical Characteristics (continued)



**Figure 7-45. B<sub>OP\_X</sub> Threshold vs. V<sub>CC</sub>**



**Figure 7-46. B<sub>OP\_X</sub> Threshold vs. Temperature**

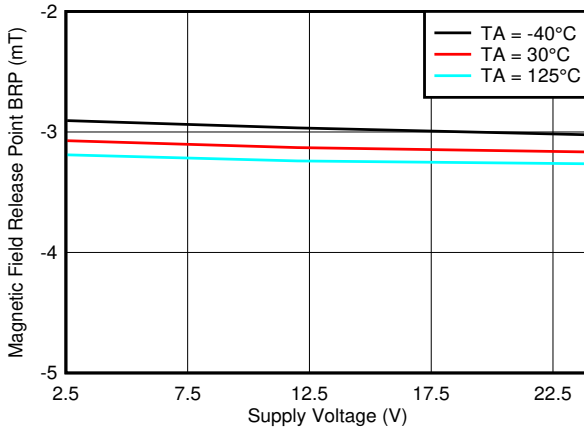

**Figure 7-47. B<sub>RP\_X</sub> Threshold vs. V<sub>CC</sub>**

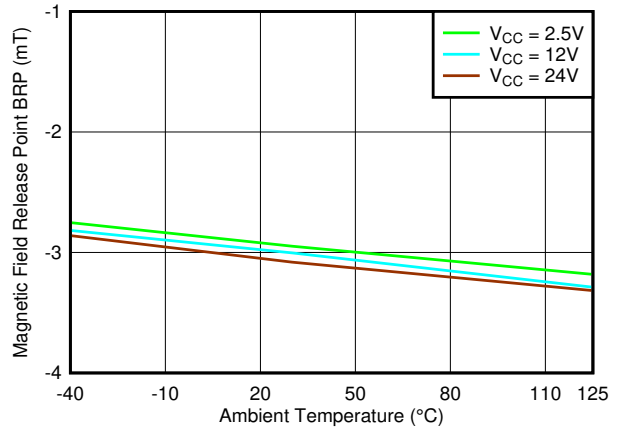

**Figure 7-48. B<sub>RP\_X</sub> Threshold vs. Temperature**

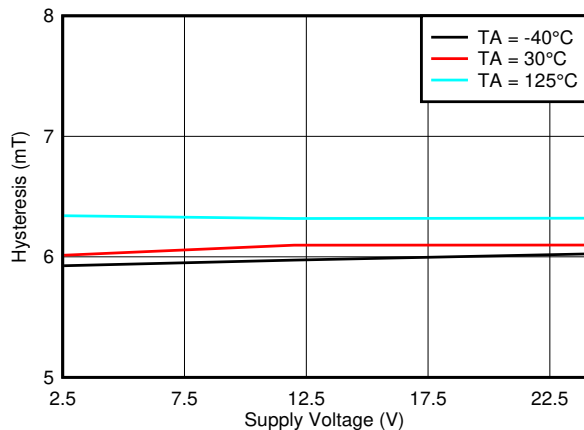

**Figure 7-49. Hysteresis\_X vs. V<sub>CC</sub>**

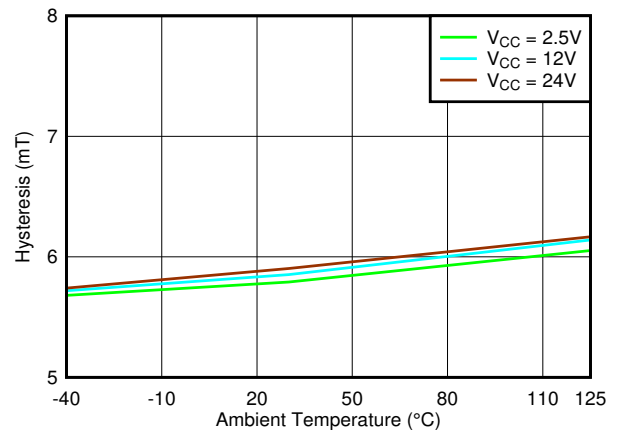

**Figure 7-50. Hysteresis\_X vs. Temperature**

### 7.7 Typical Characteristics (continued)

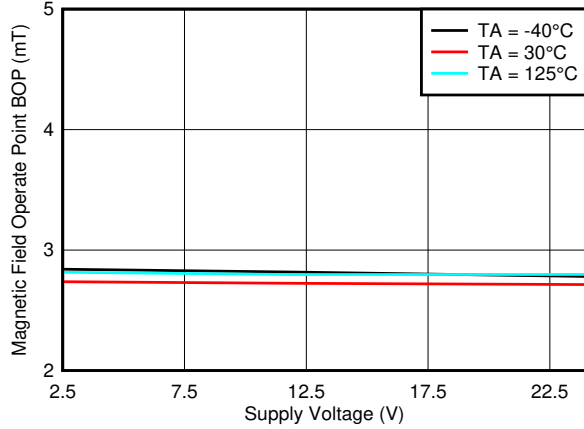

Figure 7-51. B<sub>OP\_Y</sub> Threshold vs. V<sub>CC</sub>

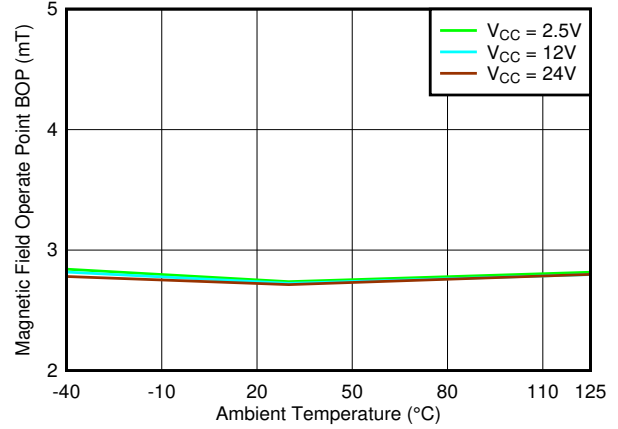

Figure 7-52. B<sub>OP\_Y</sub> Threshold vs. Temperature

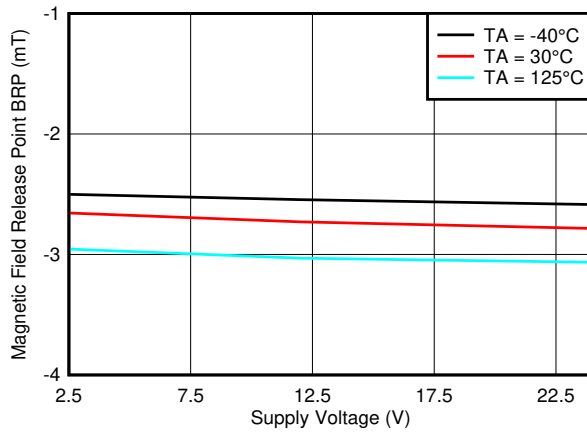

Figure 7-53. B<sub>RP\_Y</sub> Threshold vs. V<sub>CC</sub>

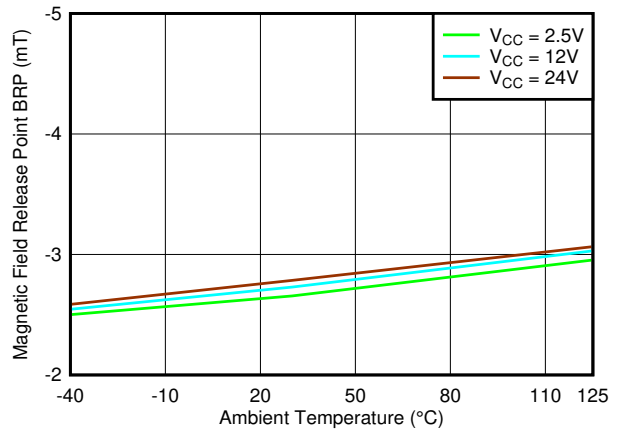

Figure 7-54. B<sub>RP\_Y</sub> Threshold vs. Temperature

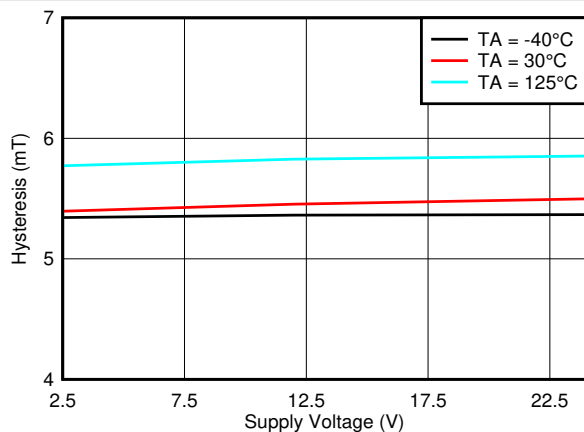

Figure 7-55. Hysteresis<sub>Y</sub> vs. V<sub>CC</sub>

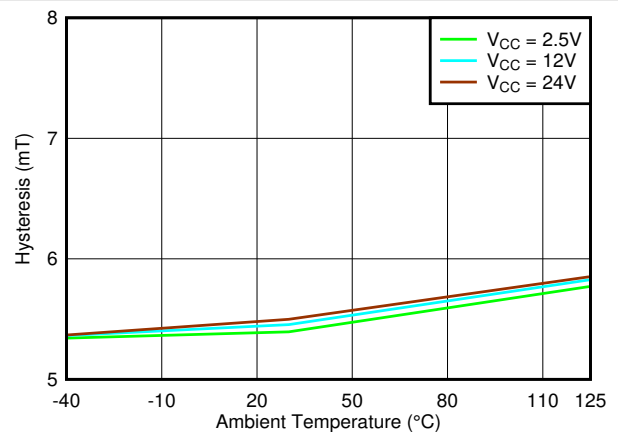

Figure 7-56. Hysteresis<sub>Y</sub> vs. Temperature



### 7.7 Typical Characteristics (continued)

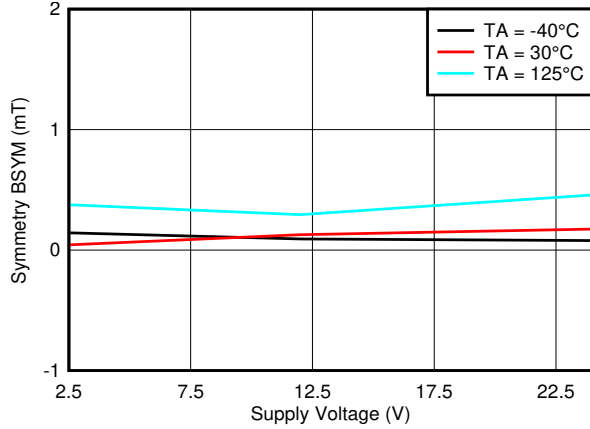

Figure 7-57.  $B_{SYM(Z)}$  vs.  $V_{CC}$

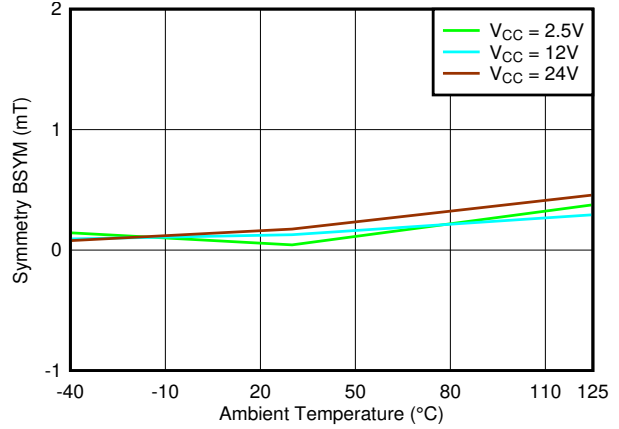

Figure 7-58.  $B_{SYM(Z)}$  vs. Temperature

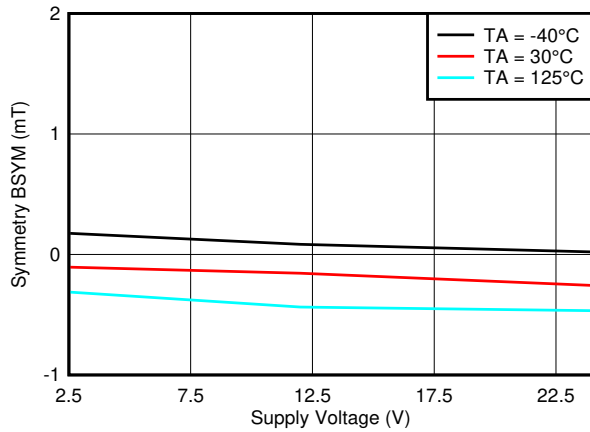

Figure 7-59.  $B_{SYM(X)}$  vs.  $V_{CC}$

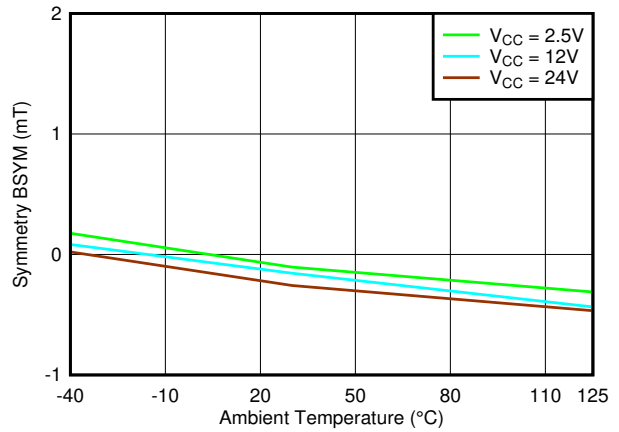

Figure 7-60.  $B_{SYM(X)}$  vs. Temperature

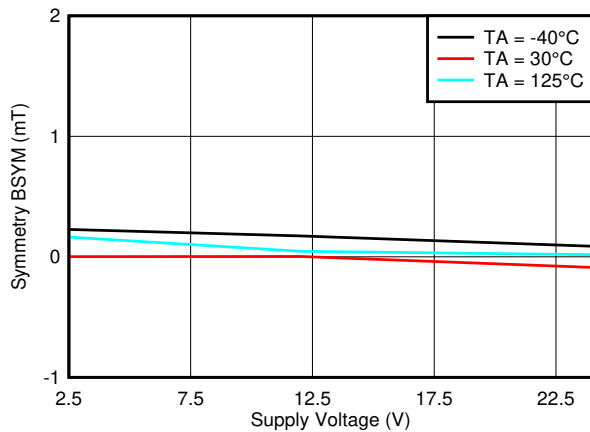

Figure 7-61.  $B_{SYM(Y)}$  vs.  $V_{CC}$

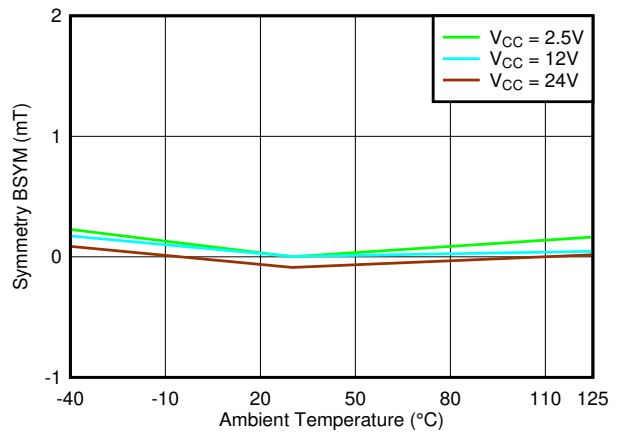

Figure 7-62.  $B_{SYM(Y)}$  vs. Temperature

### 7.7 Typical Characteristics (continued)

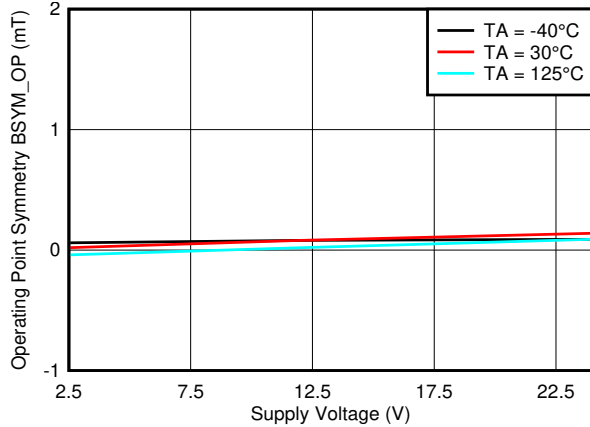

Figure 7-63.  $B_{SYM\_OP}(ZX)$  vs.  $V_{CC}$

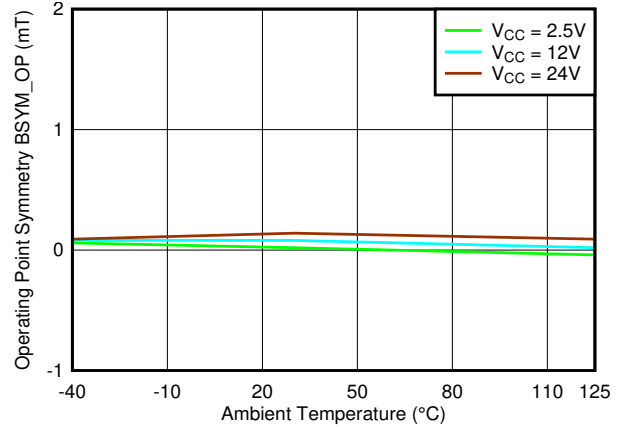

Figure 7-64.  $B_{SYM\_OP}(ZX)$  vs. Temperature

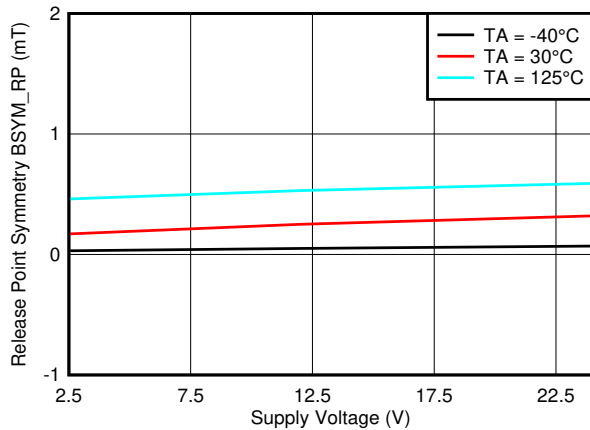

Figure 7-65.  $B_{SYM\_RP}(ZX)$  vs.  $V_{CC}$

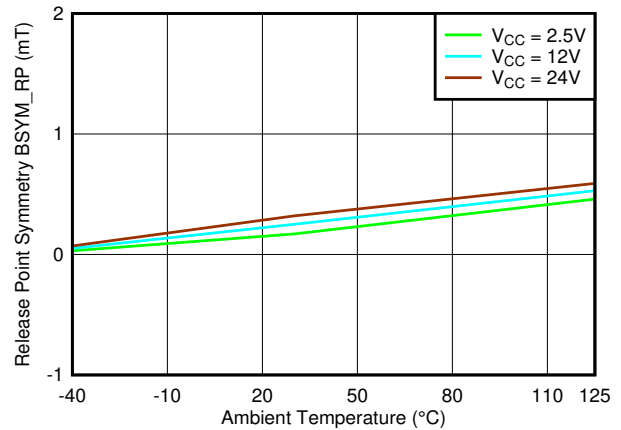

Figure 7-66.  $B_{SYM\_RP}(ZX)$  vs. Temperature

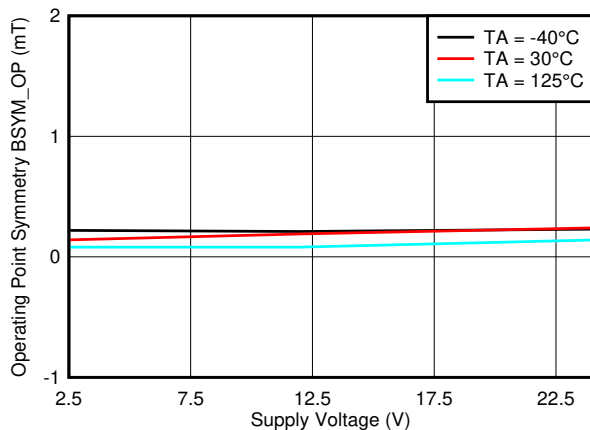

Figure 7-67.  $B_{SYM\_OP}(ZY)$  vs.  $V_{CC}$

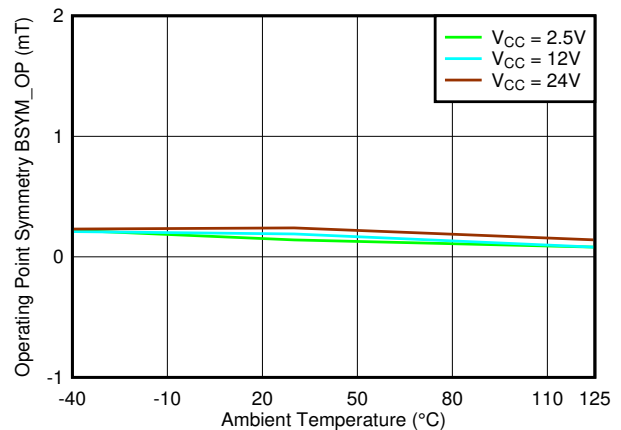

Figure 7-68.  $B_{SYM\_OP}(ZY)$  vs. Temperature

## 7.7 Typical Characteristics

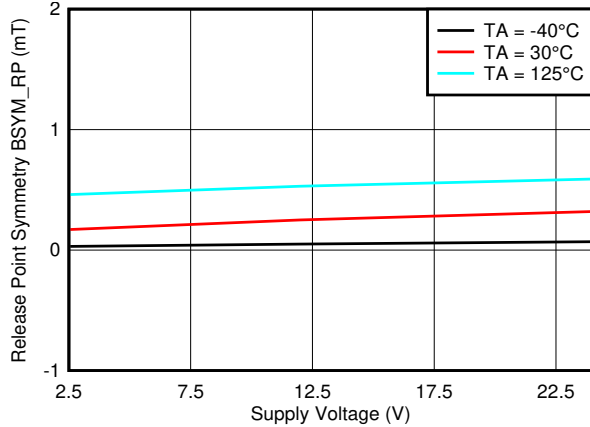

Figure 7-69.  $B_{SYM\_RP(ZY)}$  vs.  $V_{CC}$

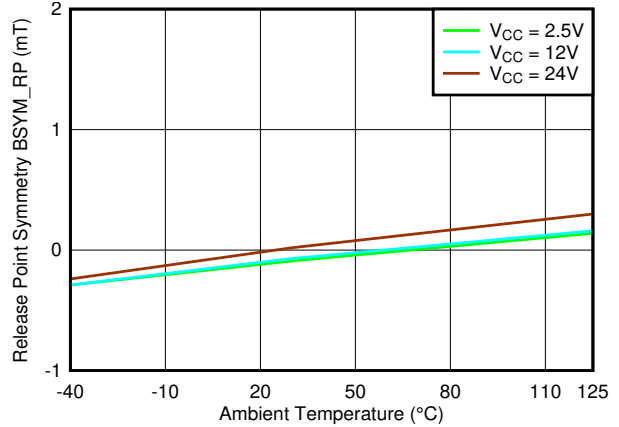

Figure 7-70.  $B_{SYM\_RP(ZY)}$  vs. Temperature

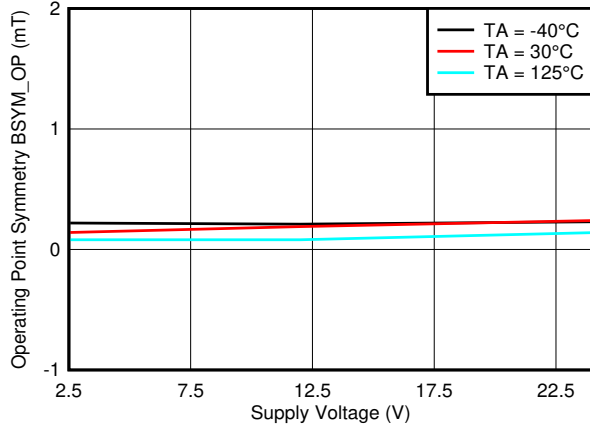

Figure 7-71.  $B_{SYM\_OP(XY)}$  vs.  $V_{CC}$

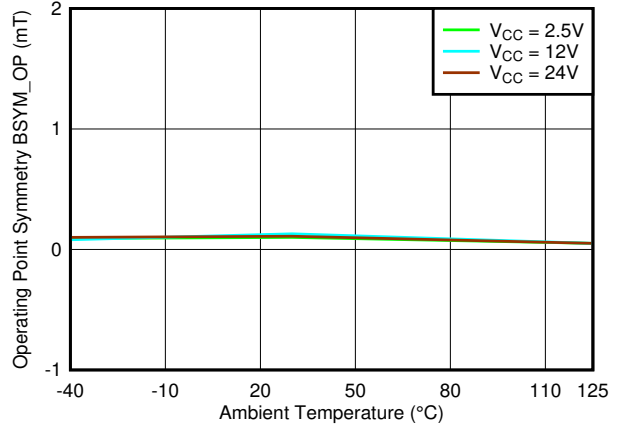

Figure 7-72.  $B_{SYM\_OP(XY)}$  vs. Temperature

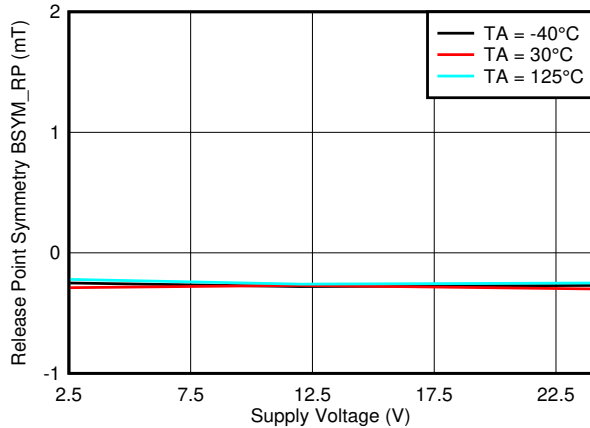

Figure 7-73.  $B_{SYM\_RP(XY)}$  vs.  $V_{CC}$

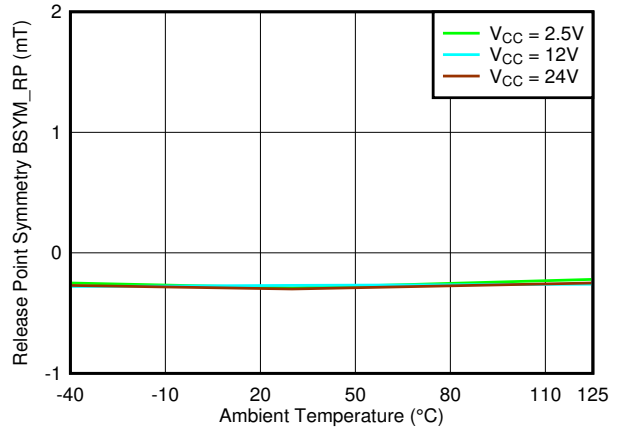

Figure 7-74.  $B_{SYM\_RP(XY)}$  vs. Temperature

### 7.7 Typical Characteristics (continued)

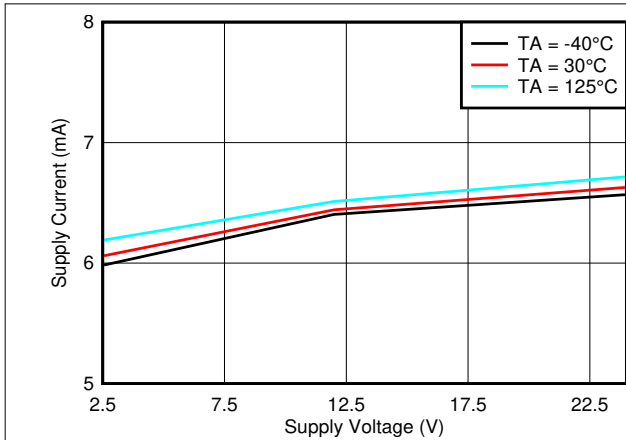

Figure 7-75. Supply Current vs.  $V_{CC}$

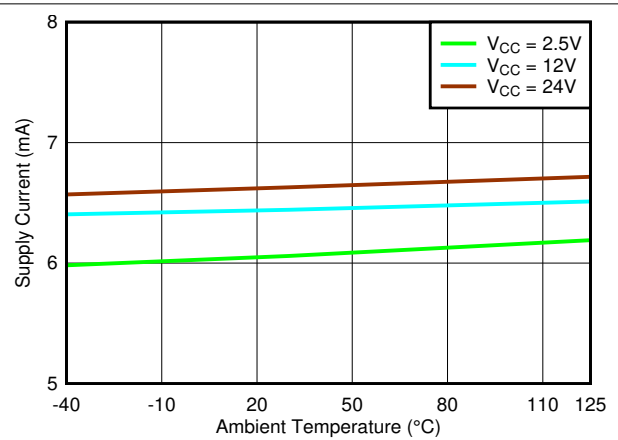

Figure 7-76. Supply Current vs. Temperature

## 8 Detailed Description

### 8.1 Overview

The TMAG5110 and TMAG5111 are dual chopper-stabilized Hall effect sensors with two digital latched outputs for rotational magnetic sensing applications. The TMAG511x device can be powered with a supply voltage between 2.5 V and 38 V, and survives continuous  $-20$  V reverse-battery conditions. The TMAG511x device only operates when a voltage of 2.5 V to 38 V applied to the  $V_{CC}$  pin (with respect to the GND pin). In addition, the device can withstand voltages up to 40 V for transient durations.

Alternating north and south magnetic poles are required to toggle the outputs of each Hall-effect latch.

The device is offered in a standard 3 mT typical operating point, as well as a high-sensitivity 1.4 mT typical operating point. The higher magnetic sensitivity provides flexibility in low-cost magnet selection and mechanical component placement. The TMAG511x is also available in three 2-axis combination options (X-Y, Z-X, Z-Y) to support flexible multiple installation orientations relative to the magnet.

### 8.2 Functional Block Diagram

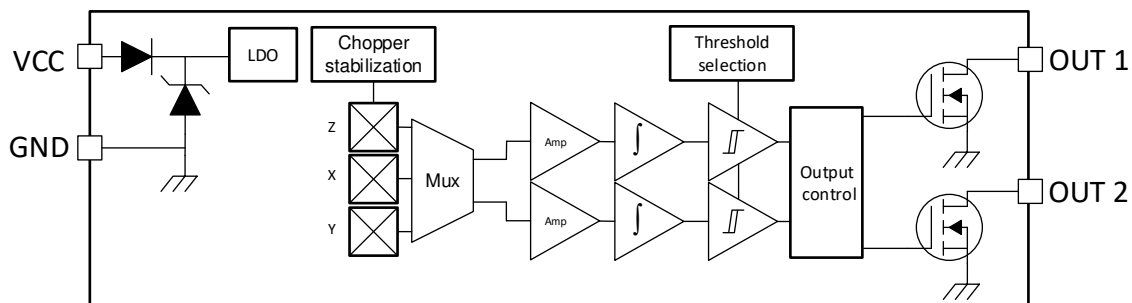

### 8.3 Feature Description

#### 8.3.1 2D Description

##### 8.3.1.1 2D General Description and Advantages

The best way to understand the advantage of a 2D dual latch hall sensor is to compare its behavior with others solutions used in the market. The two most common methods are: dual planar hall latch sensors or two single hall latch sensors. Those methods are used in applications such as rotary encoding or speed and direction sensing. The principle is to set two sensors apart at a certain angle such that they will sense the same magnetic field but with a fixed phase difference. The frequency of the signal will give the speed or incremental information while the phase will give the direction of rotation. For an easy read, the signals should be as close to a quadrature signal as possible, meaning there is a  $90^\circ$  phase shift between the two signals. To create those two signals in quadrature, the two latches must be placed at a distance of  $\frac{1}{2}$  pole + n pole from one another.

The TMAG511x can be used instead of a dual planar hall latch or two single hall latch sensors. The TMAG511x has two integrated hall latch sensors spaced at a  $90^\circ$  angle from each other, which allows each sensor to detect a quadrature component of the same magnetic field. For A, B, and C device variants, the magnetic direction detected will be XY, ZX, and ZY, respectively. Each of those components are placed at  $90^\circ$  from each other by design, therefore the output signals will also be separated with the same angle value. Wherever the sensor is placed to catch the right two components of the field, the output will be in quadrature from one another. [Figure 8-1](#) shows the result of two different type of sensors when the devices are placed close to a ring magnet.

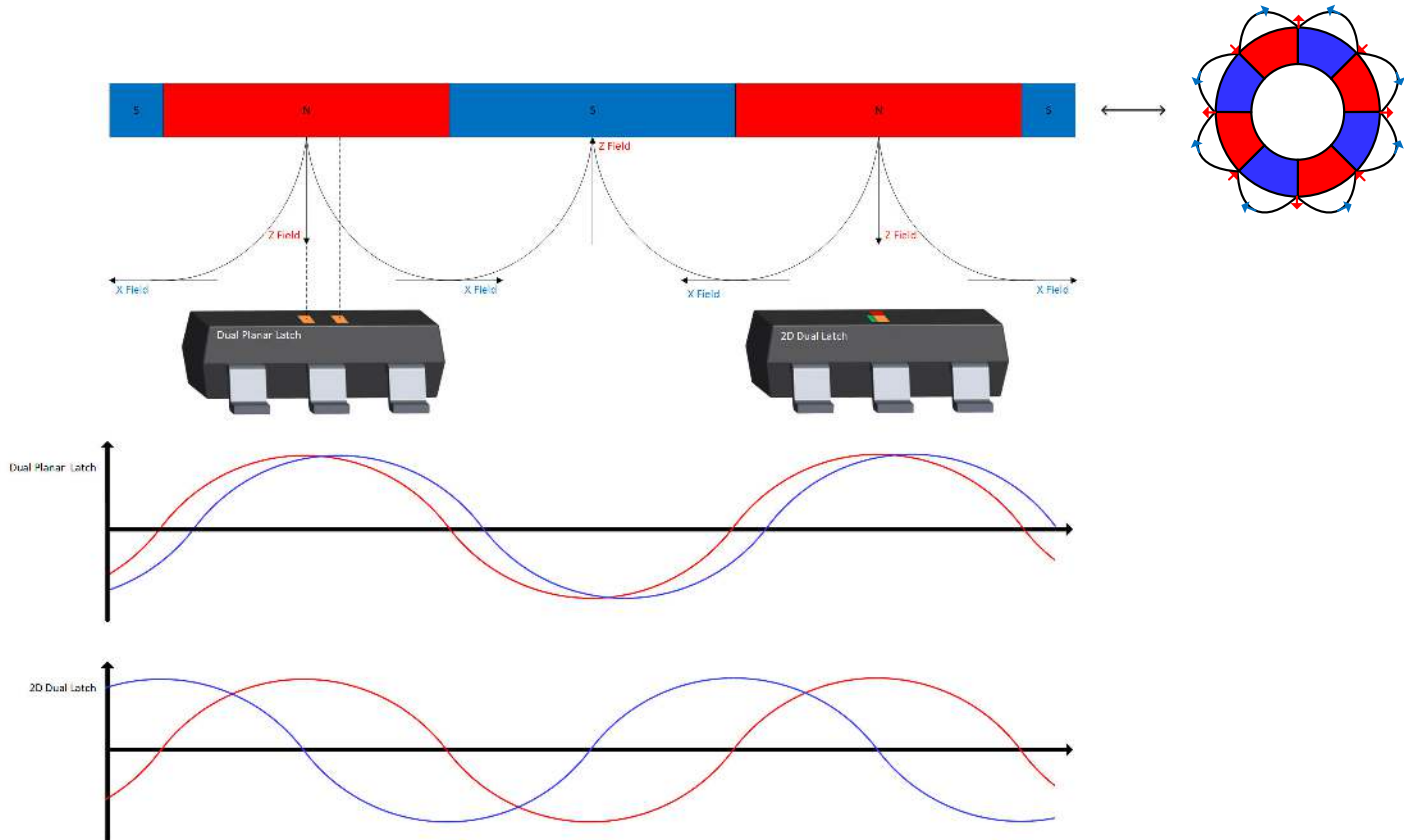

Figure 8-1. Dual Planar Latch vs. 2D Dual Latch

### 8.3.1.2 2D Magnetic Sensor Response

The TMAG5110 has two integrated latches that update their results to the OUT1 and OUT2 pins. Each one of these outputs will then have a latch functionality. Figure 8-2 shows the response to different magnetic poles for each output.

The TMAG5111 outputs are not directly connected to the two integrated latches. Additional processing is available to generate the speed and direction outputs.

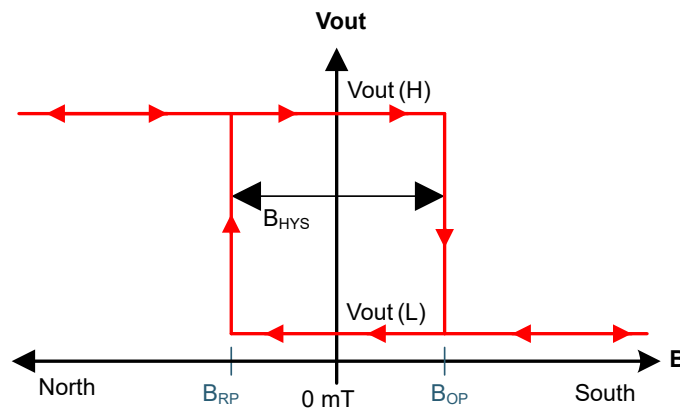

Figure 8-2. Latch Functionality

Figure 8-3 shows the magnetic response of both the TMAG5110 and TMAG5111 to a sinusoidal field. The sinusoidal curves represents the evaluation of the magnetic seen by both integrated hall sensors.

The TMAG5110 response shows both outputs reacting to this signal by going low once the field is higher than  $B_{OP}$  and going high when the field is lower than  $B_{RP}$ .

The TMAG5111 response shows how those two signals are processed to create a speed output and a direction output.

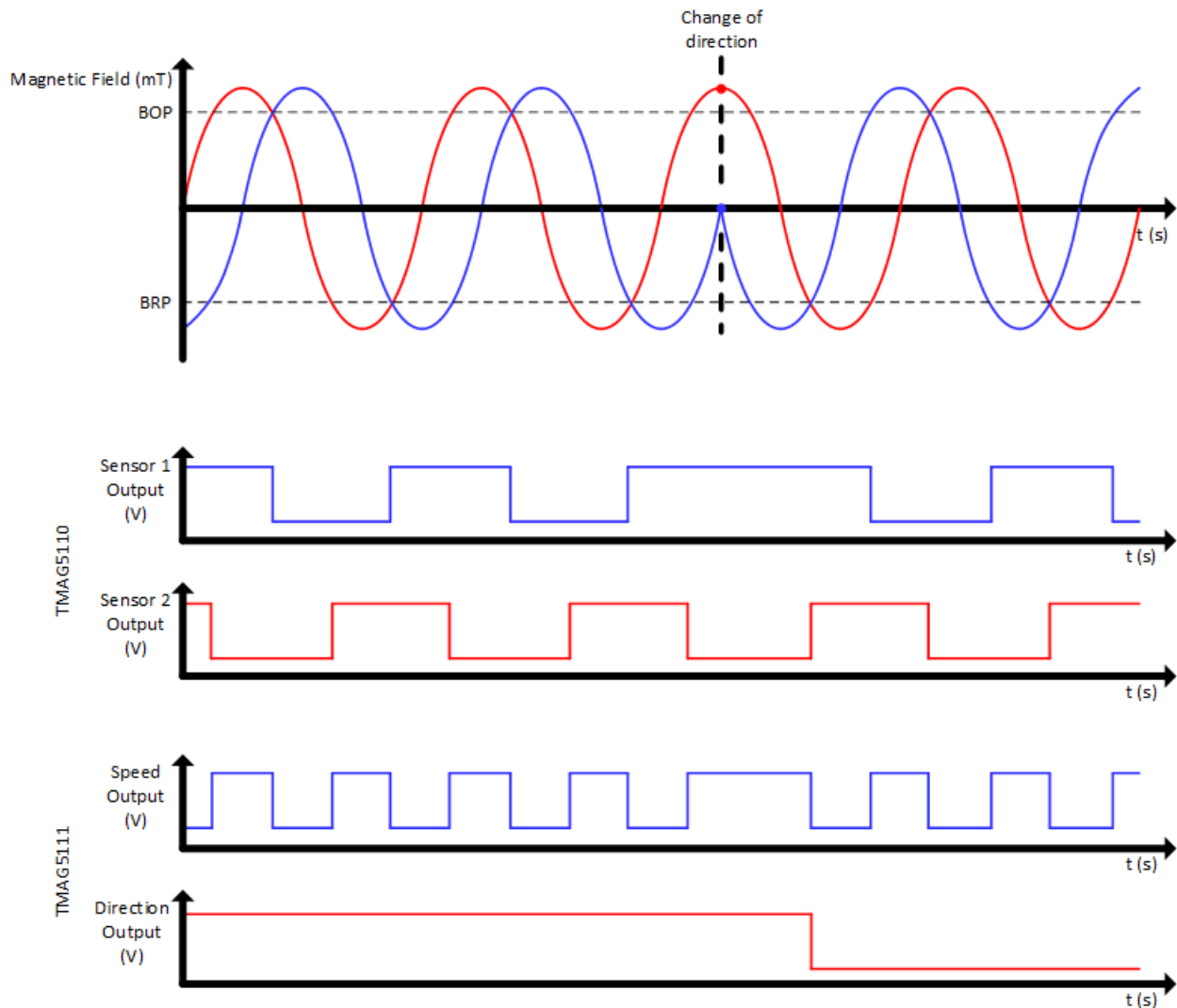

Figure 8-3. TMAG511x Output Behavior

### 8.3.1.3 Axis Polarities

The Figure 8-4 shows the directions from where each axes are sensitive to a south pole. This also shows that the opposite directions are sensitive to the north pole.

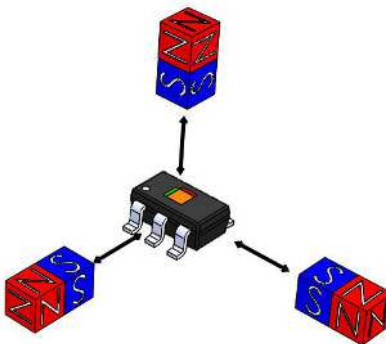

Figure 8-4. Axis Polarities

### 8.3.2 Axis Options

#### 8.3.2.1 Device Placed In-Plane to Magnet

The outer edge of the magnet is the area where the magnetic field is the strongest. Placing the sensor on the outer edge of the magnet enables the sensor to get the best flexibility in terms of distance and sensitivity selection. The different figures below show how to use the different versions of the TMAG511x in regards to the magnet and sensor placement.

The options shown in [Figure 8-5](#) and [Figure 8-6](#) composed of the X and Y axes enable the sensor to be placed in the same plane as the ring magnet. The sensor can be placed facing the magnet or on the side of the magnet. The part can also be turned at 180 degrees along the Z axis.

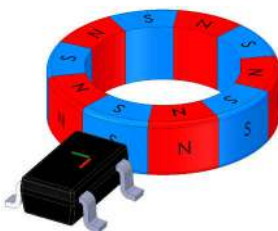

Figure 8-5. XY Outer Edge 1

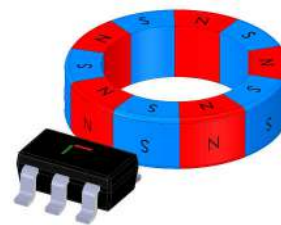

Figure 8-6. XY Outer Edge 2

The options shown in [Figure 8-7](#) and [Figure 8-8](#) composed of Z and X axes enable the sensor to be placed below the magnet, or facing the magnet with the front side of the device. The part can also be turned at 180 degrees along the Z axis.



Figure 8-7. ZX Outer Edge 1



Figure 8-8. ZX Outer Edge 2

The options shown in [Figure 8-9](#) and [Figure 8-10](#) composed of Z and Y axes also enable the sensor to be placed below the magnet in a different position, as well as facing the ring magnet with the side of the device. The part can also be turned at 180 degrees along the Z axis.



Figure 8-9. ZY Outer Edge 1



Figure 8-10. ZY Outer Edge 1



### 8.3.2.2 Device Placed on the Side Edge of the Magnet

The side edge of the magnet still provides a magnetic field, but the field is much weaker than the field on the outer edge. Placing the sensor on the side edge minimizes the flexibility as of how far the device can be placed from the ring magnet. The 2 mT version enables high sensitivity, allowing the application to work as well as when the device is placed on the outer edge. Nevertheless this option can be helpful in application where the sensor has to fit within the magnet diameter.

The options shown in [Figure 8-11](#) and [Figure 8-12](#) composed of X and Y axes enable the sensor to be placed facing the side edge of the magnet. The side of the sensor can also be placed next to the side edge of the magnet. The part can also be turned at 180 degrees along the Z axis.

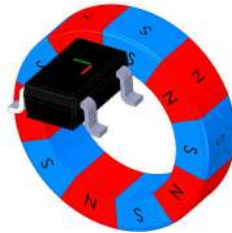

**Figure 8-11. XY Side Edge 1**

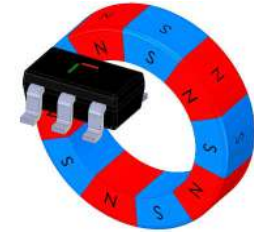
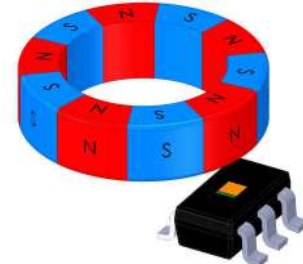

**Figure 8-12. XY Side Edge 2**

The options shown in [Figure 8-13](#) and [Figure 8-14](#) composed of Z and X axis enable another way to place the sensor facing the side edge of the magnet. The top of the sensor can also be placed facing the side edge of the magnet. The part can also be turned at 180 degrees along the Z axis.



**Figure 8-13. ZX Side Edge 1**

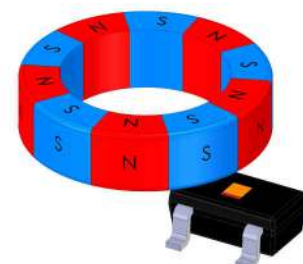

**Figure 8-14. ZX Side Edge 2**

The options shown in [Figure 8-15](#) and [Figure 8-16](#) composed of Z and Y axes enable the placement of the sensor on the side edge of a magnet with the pins facing the magnet, or with top of the sensor facing the side edge of the magnet. The part can also be turned at 180 degrees along the Z axis.



**Figure 8-15. ZY Side Edge 1**



**Figure 8-16. ZY Side Edge 1**

### 8.3.3 Power-On Time

Figure 8-17 shows the behavior of the device after the  $V_{CC}$  voltage is applied and when the field is below the  $B_{OP}$  threshold. Once the minimum value for  $V_{CC}$  is reached, the TMAG5110 will take time  $t_{ON}$  to power up and then time  $t_{PD}$  to update the output to a level High.

Figure 8-18 shows the behavior of the device after the  $V_{CC}$  voltage is applied and when the field is above the  $B_{OP}$  threshold. Once the minimum value for  $V_{CC}$  is reached, the TMAG5110 will take time  $t_{ON}$  to power up and then time  $t_{PD}$  to update the output to a level High.

For the TMAG5111 the power-on behavior is similar but OUT1 will be updated to Low during the  $t_{PD}$  time. OUT2 will be updated to High during the  $t_{PD}$  time. The output value following the power-on sequence will then depend on the magnet placement, the sense of rotation and the device variant.

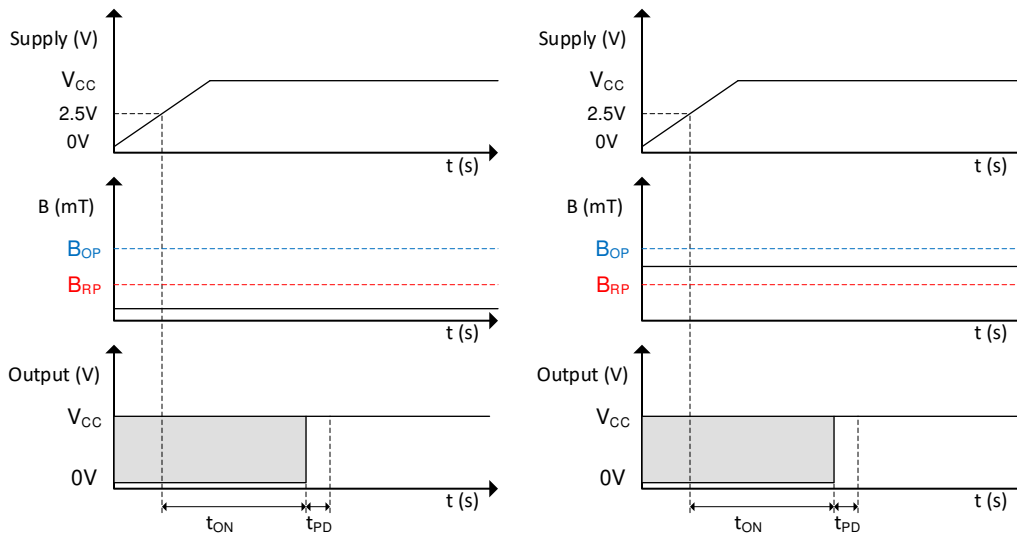

Figure 8-17. Power-On Time When  $B < B_{OP}$

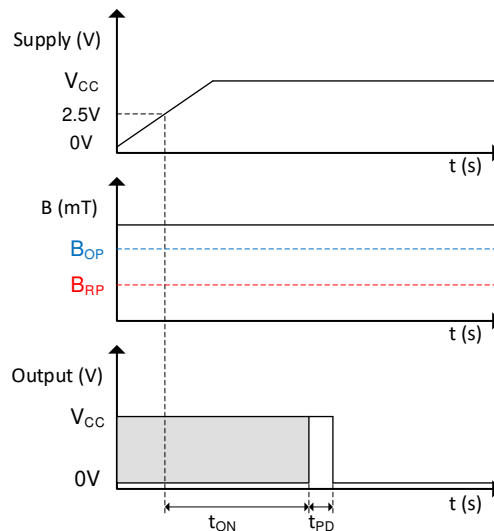

Figure 8-18. Power-On Time When  $B > B_{OP}$

### 8.3.4 Propagation Delay

The TMAG511x samples the Hall element at a nominal sampling interval of  $t_{PD}$  to detect the presence of a magnetic south pole. Between each sampling interval, the device calculates the average magnetic field applied to the device. As defined in Figure 8-20, if this average value crosses the  $B_{OP}$  or  $B_{RP}$  threshold, the device changes the corresponding level. Because the system, Hall sensor + magnet is by nature asynchronous, the propagation delay  $t_d$  will vary depending on when the magnetic field goes above the  $B_{OP}$  value. As shown in Figure 8-19 the output delay will then depend on when the magnetic field will get higher than the  $B_{OP}$  value. The first graph shows the typical case.

The magnetic field goes above the  $B_{OP}$  value at the moment where the output is updated. The part will then only need one cycle of  $t_{PD}$  to update the output. The second graph shows a magnetic field going above the  $B_{OP}$  value just right before half of the sampling period. This is the best case possible where the output will be updated in just half of the sampling period. Finally, the third graph shows the worst possible case where the magnetic field goes above the  $B_{OP}$  value just after half of the sampling period. At the next output update, the value will still see a value under the threshold and will need a whole new period to update the output

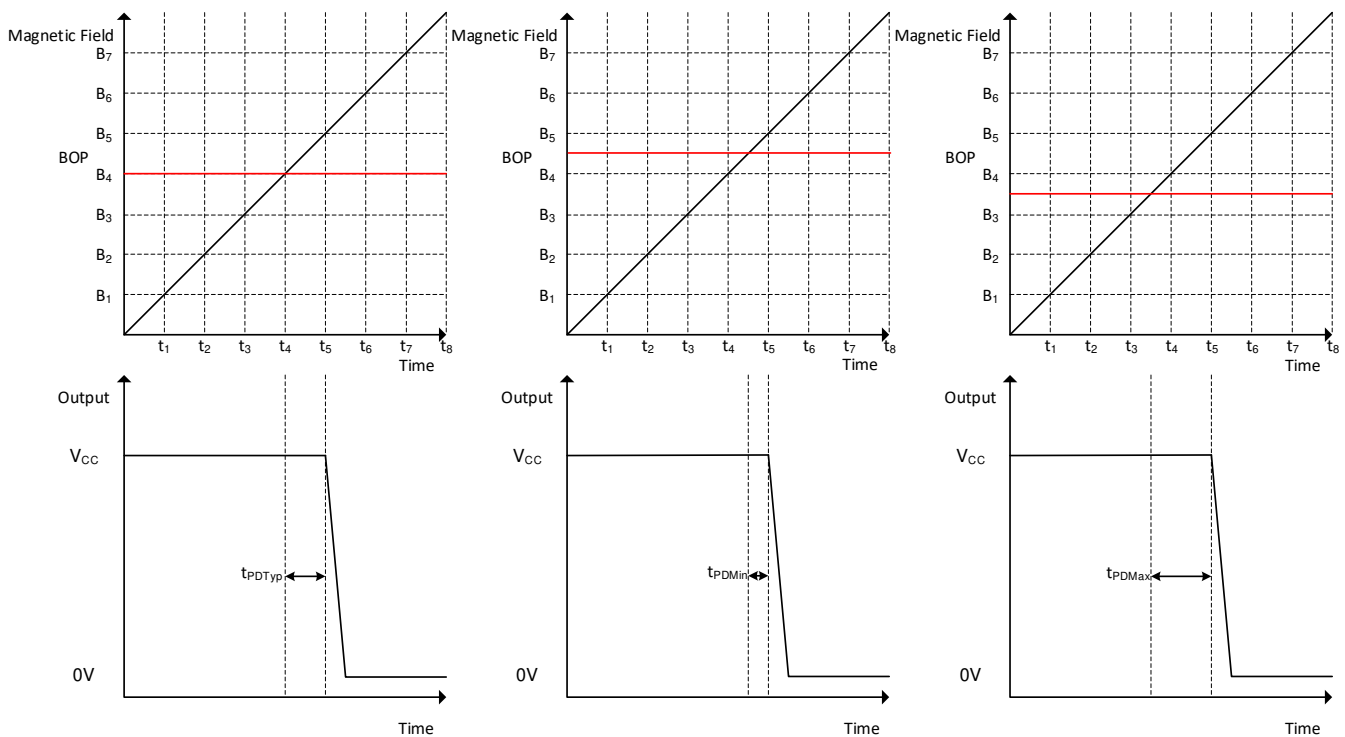

Figure 8-19. Field Sampling Timing

Figure 8-20 shows TMAG511x propagation delay analysis when a magnetic south pole is applied. The Hall element of the TMAG511x experiences an increasing magnetic field as a magnetic south pole approaches near the device as well as a decreasing magnetic field as a magnetic south pole leaves away. At time  $t_1$  the magnetic field goes above the  $B_{OP}$  threshold. The output will then start to move after the time  $t_{PD}$ . As shown in Figure 8-20, this time will vary depending on when the sampling period is. At  $t_2$  the output start pulling to the low voltage value. At  $t_3$  the output is completely pulled down to the lower voltage value. The same process happen on the other way when the magnetic value is going under the  $B_{OP}$  threshold.

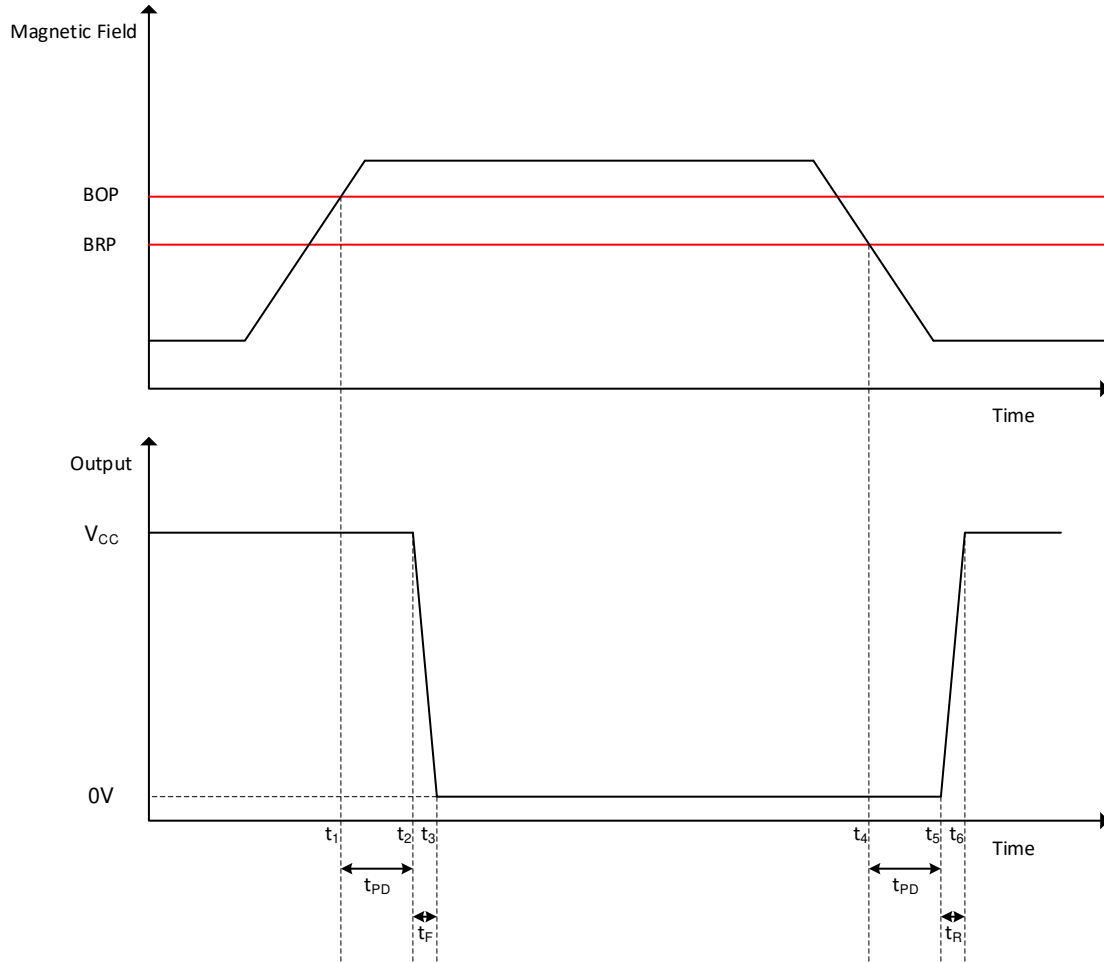
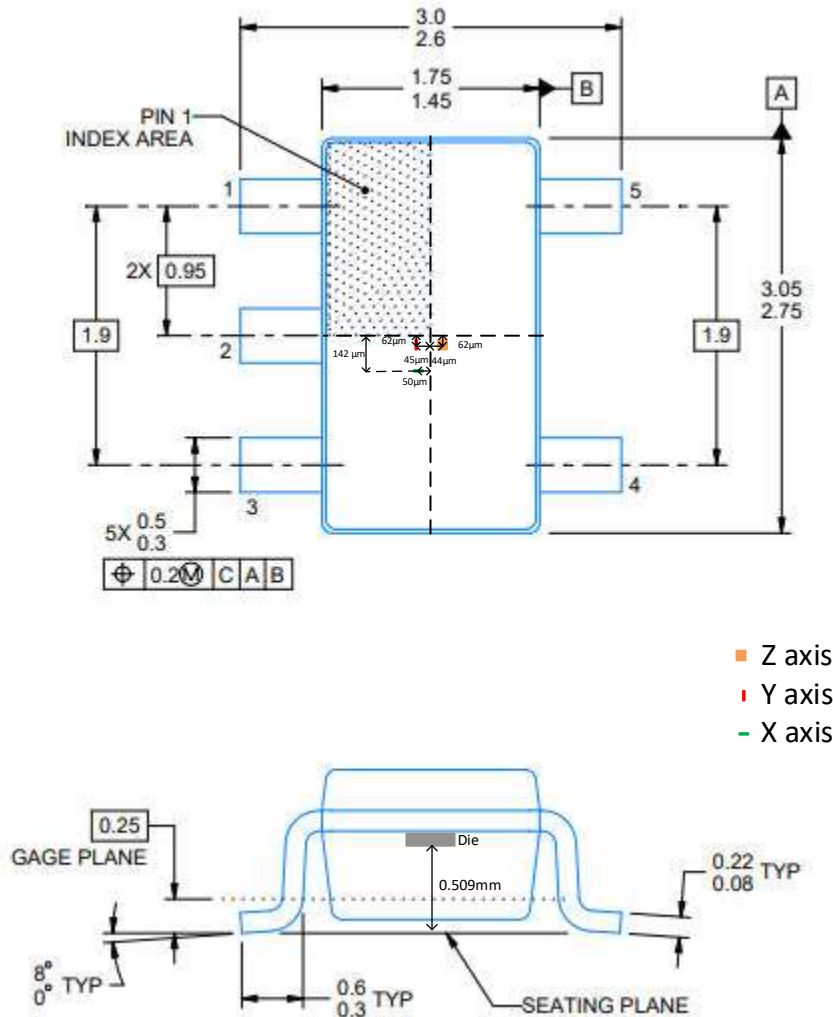

Figure 8-20. Propagation Delay

### 8.3.5 Hall Element Location

The sensing element inside the device is in the center when viewed from the top. [Figure 8-21](#) shows the exact position of the sensors in regard of the package.



**Figure 8-21. Hall Element Location**

### 8.3.6 Power Derating

The device is specified from  $-40\text{ }^{\circ}\text{C}$  to  $125\text{ }^{\circ}\text{C}$  for a voltage rating of 2.5 V to 38 V. Because the part is draining at its maximum a current of 17 mA the maximum voltage that can be applied will depend on what is the maximum ambient temperature acceptable for the application. The curve in [Figure 8-22](#) shows the maximum acceptable power supply voltage versus the maximum acceptable ambient temperature.

The [Figure 8-22](#) can also be calculated using the following formulas:

$$T_J = T_A + \Delta T \quad (1)$$

where

- $T_J$  is the junction temperature
- $T_A$  is the ambient temperature
- $\Delta T$  is the difference between the junction temperature and the ambient temperature

$$\Delta T = P_D \times R_{\theta JA} \quad (2)$$

where

- $P_D$  is the power dissipated by the part
- $R_{\theta JA}$  is the junction to ambient thermal resistance

$$P_D = V_{CC} \times I_{CC} \quad (3)$$

where

- $V_{CC}$  is the voltage supply of the device
- $I_{CC}$  is the current consumption of the device

Combining the three equations above gives [Equation 4](#) below:

$$V_{CC \text{ max}} = \frac{T_{J \text{ max}} - T_A}{I_{CC \text{ max}} \times R_{\theta JA}} \quad (4)$$

This equation gives the maximum voltage the part can handle in regards of the ambient temperature.

For example, in the application required to work within a ambient temperature of maximum 85 °C, with  $T_{J \text{ max}}$ ,  $R_{\theta JA}$  and  $I_{CC \text{ max}}$  are defined in the data sheet, the maximum voltage allowed for this application is determined in [Equation 5](#):

$$V_{CC \text{ MAX}} = \frac{150^\circ\text{C} - 120^\circ\text{C}}{6.5 \text{ mA} \times 166.5^\circ\text{C/W}} = 27.72 \text{ V}$$

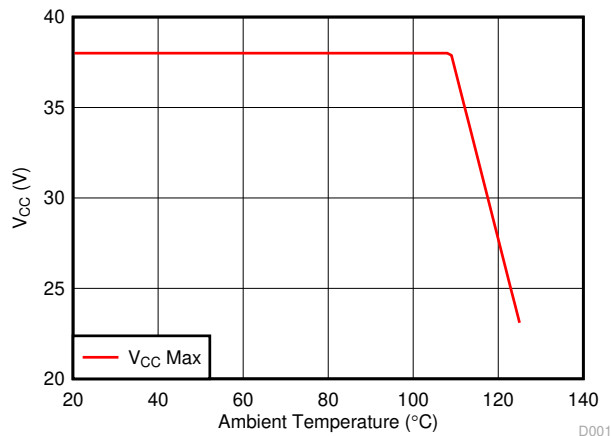

**Figure 8-22. Power Derating Curve**

## 8.4 Device Functional Modes

The TMAG511x device has one mode of operation that applies when the [Recommended Operating Conditions](#) are met.

## 9 Application and Implementation

### Note

Information in the following applications sections is not part of the TI component specification, and TI does not warrant its accuracy or completeness. TI's customers are responsible for determining suitability of components for their purposes, as well as validating and testing their design implementation to confirm system functionality.

### 9.1 Application Information

The TMAG511x is designed for rotary applications for DC motor sensors or incremental rotary encoding.

For reliable functionality, the magnet must apply a flux density at the sensor greater than the corresponding maximum  $B_{OP}$  or  $B_{RP}$  numbers specified in the [Magnetic Characteristics](#) table. Add additional margin to account for mechanical tolerance, temperature effects, and magnet variation. Magnets generally produce weaker fields as temperature increases.

### 9.2 Typical Applications

#### 9.2.1 Incremental Rotary Encoding Application

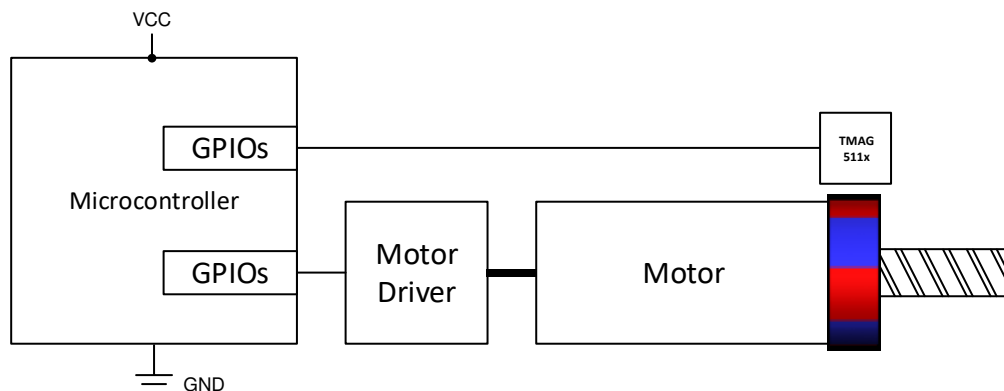

**Figure 9-1. Incremental Encoding**

#### 9.2.1.1 Design Requirements

[Table 9-1](#) lists the use the parameters for this design.

**Table 9-1. Design Parameters**

DESIGN PARAMETER	EXAMPLE VALUE
Motor speed	22.5 kRPM
Number of magnet poles	8
Dimensions	9.7 mm diameter × 2 mm thick
Magnetic material	Ceramic 8D
Air gap above the Hall sensors	2.5 mm
Radial magnetic flux density peak	±12.5 mT
Tangential magnetic flux density peak	±9.5 mT

### 9.2.1.2 Detailed Design Procedure

Incremental encoders are used on knobs, wheels, motors, and flow meters to measure relative rotary movement. By attaching a ring magnet to the rotating component and placing the TMAG511x nearby, the sensor will generate voltage pulses as the magnet turns. The TMAG511x integrates two sensors and two signal chains. This means each channel can go up to the maximum speed independently from each other.

When the magnet rotates, the TMAG5110 will generate alternate pulses on each output. One input will be the result of what is sensed from one specific axis, while the other output will sense from another specific axis. In [Table 9-1](#), this is also referred as Radial and Tangential magnetic flux. Those two signals are the result of two different components of the same magnetic field resulting in the two signals being 90° from one another. Also called quadrature output, this type of signal is ideal to measure a rotational count as well as a change in direction of the ring magnet.

The TMAG5111 directly generates the speed and direction outputs. This eliminates the need for external processing.

The maximum rotational speed that can be measured is limited by the sensor bandwidth and the magnetic strength of the magnet.

Generally, the bandwidth must be faster than two times the number of poles per second. In this design example, the maximum speed is 22500 RPM, which involves a rotation of 3000 poles per second when using an 8-pole magnet. The TMAG511x sensing bandwidth is typically 40 kHz, which is more than thirteen times the pole frequency.

The strength of the magnet also has an impact on how fast the magnet can turn. A weaker magnet with a maximum strength very close to the threshold value will limit the maximum speed by limiting the amount of time where this field will be higher than the B<sub>OP</sub>. The time spent above the B<sub>OP</sub> value will be longer for a magnet with stronger field.

When the magnet strength is significantly higher than B<sub>OP</sub>, [Equation 5](#) can be used to calculate the allowed speed.

$$\text{Speed (RPM)} \leq \frac{\text{Bandwidth (Hz)} \times 60}{\text{Number of poles}} \tag{5}$$

### 9.2.1.3 Application Curve

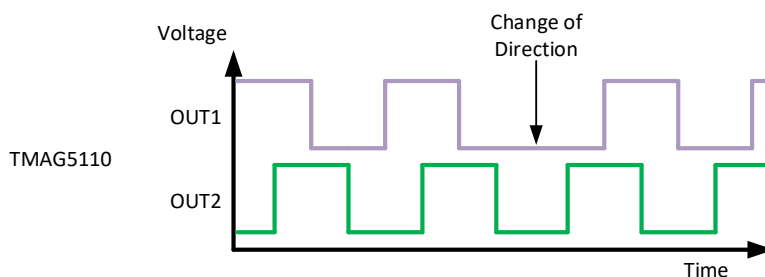

Figure 9-2. TMAG5110 Output Response

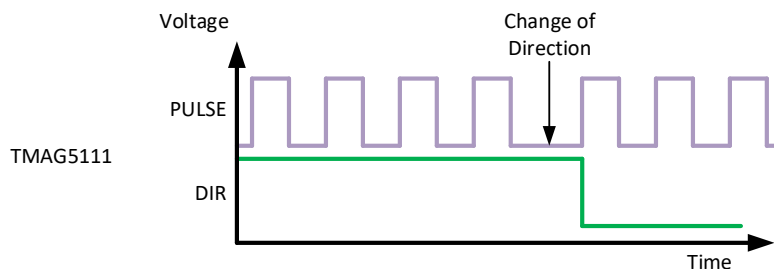

Figure 9-3. TMAG5111 Output Response



## 10 Power Supply Recommendations

The TMAG511x is powered by 2.5-V to 38-V DC power supplies. A decoupling capacitor placed close to the device must be used to provide local energy with minimal inductance. TI recommends using a ceramic capacitor with a value of at least 0.01  $\mu\text{F}$ .

## 11 Layout

### 11.1 Layout Guidelines

Magnetic fields pass through most non-ferromagnetic materials with no significant disturbance. Embedding Hall effect sensors within plastic or aluminum enclosures and sensing magnets on the outside is common practice. Magnetic fields also easily pass through most printed-circuit boards (PCBs), which makes placing the magnet on the opposite side of the PCB possible.

### 11.2 Layout Example

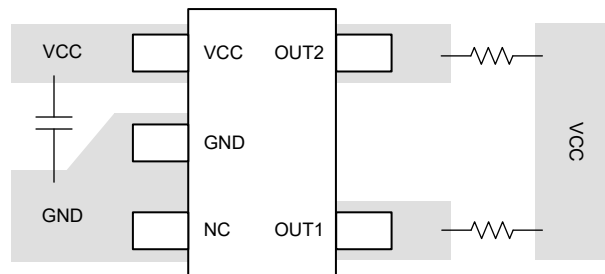

**Figure 11-1. Layout Example**

## 12 Device and Documentation Support

### 12.1 Receiving Notification of Documentation Updates

To receive notification of documentation updates, navigate to the device product folder on [ti.com](http://ti.com). Click on *Subscribe to updates* to register and receive a weekly digest of any product information that has changed. For change details, review the revision history included in any revised document.

### 12.2 Support Resources

TI E2E™ [support forums](#) are an engineer's go-to source for fast, verified answers and design help — straight from the experts. Search existing answers or ask your own question to get the quick design help you need.

Linked content is provided "AS IS" by the respective contributors. They do not constitute TI specifications and do not necessarily reflect TI's views; see TI's [Terms of Use](#).

### 12.3 Trademarks

TI E2E™ is a trademark of Texas Instruments.

All trademarks are the property of their respective owners.

### 12.4 Electrostatic Discharge Caution



This integrated circuit can be damaged by ESD. Texas Instruments recommends that all integrated circuits be handled with appropriate precautions. Failure to observe proper handling and installation procedures can cause damage.

ESD damage can range from subtle performance degradation to complete device failure. Precision integrated circuits may be more susceptible to damage because very small parametric changes could cause the device not to meet its published specifications.

### 12.5 Glossary

[TI Glossary](#) This glossary lists and explains terms, acronyms, and definitions.

## 13 Mechanical, Packaging, and Orderable Information

The following pages include mechanical, packaging, and orderable information. This information is the most current data available for the designated devices. This data is subject to change without notice and revision of this document. For browser-based versions of this data sheet, refer to the left-hand navigation.



## PACKAGE OUTLINE

**DBV0005A-C01**

**SOT-23 - 1.25 mm max height**

SMALL OUTLINE TRANSISTOR

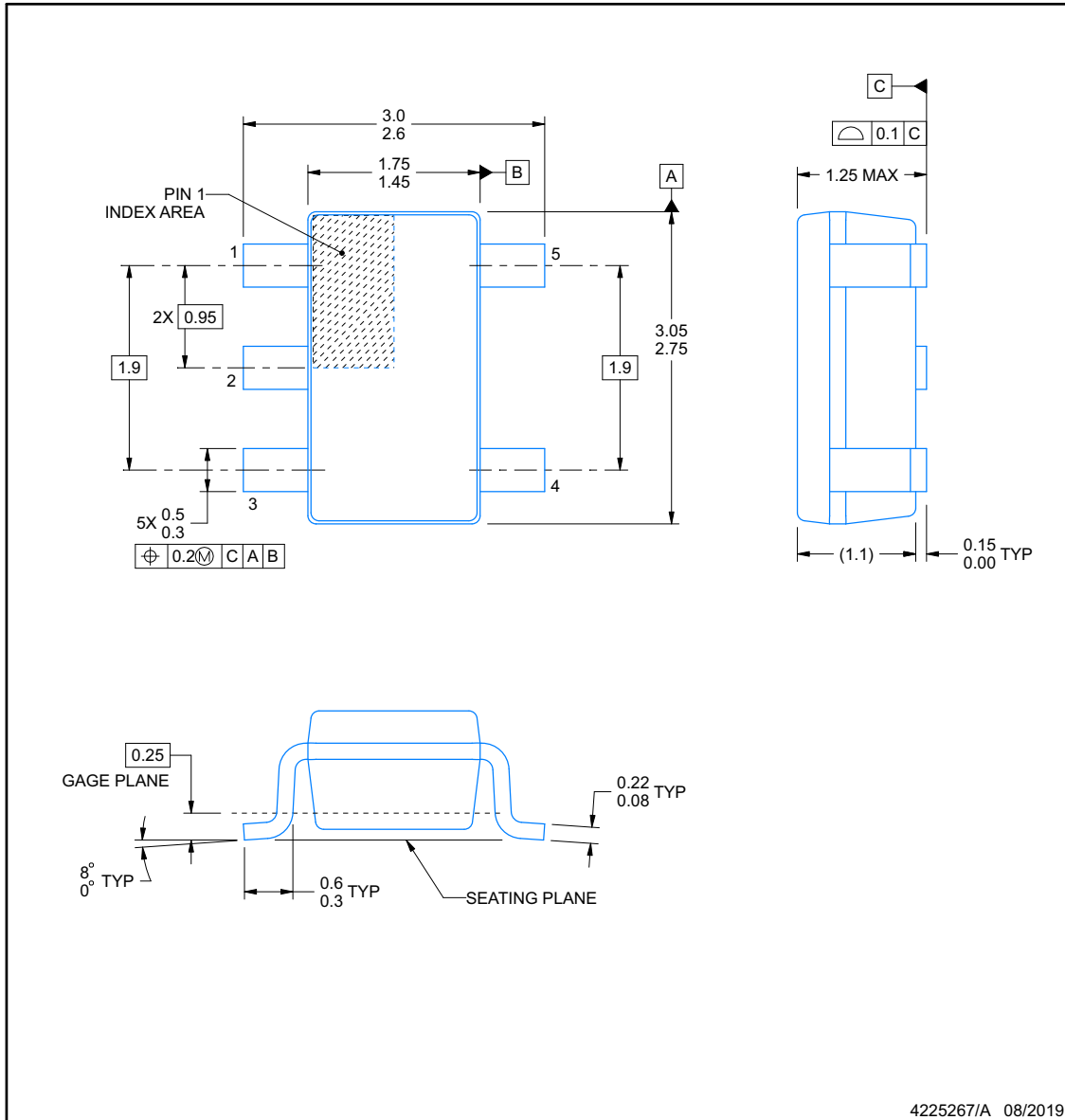

**NOTES:**

1. All linear dimensions are in millimeters. Any dimensions in parenthesis are for reference only. Dimensioning and tolerancing per ASME Y14.5M.
2. This drawing is subject to change without notice.
3. Reference JEDEC MO-178.
4. Body dimensions do not include mold flash, protrusions, or gate burrs. Mold flash, protrusions, or gate burrs shall not exceed 0.15 mm per side.

## EXAMPLE BOARD LAYOUT

**DBV0005A-C01**

**SOT-23 - 1.25 mm max height**

SMALL OUTLINE TRANSISTOR

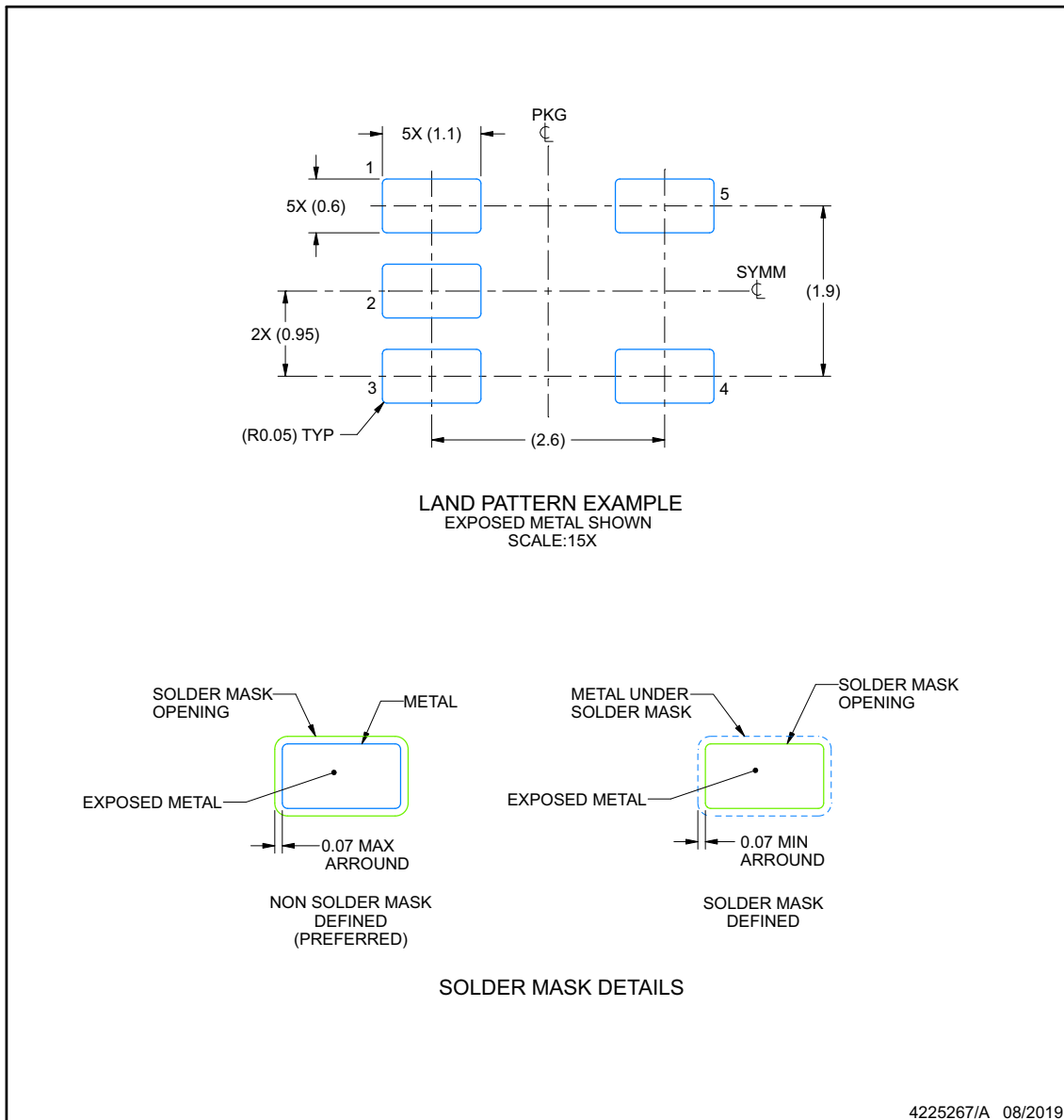

NOTES: (continued)

5. Publication IPC-7351 may have alternate designs.
6. Solder mask tolerances between and around signal pads can vary based on board fabrication site.

## EXAMPLE STENCIL DESIGN

**DBV0005A-C01**

**SOT-23 - 1.25 mm max height**

SMALL OUTLINE TRANSISTOR

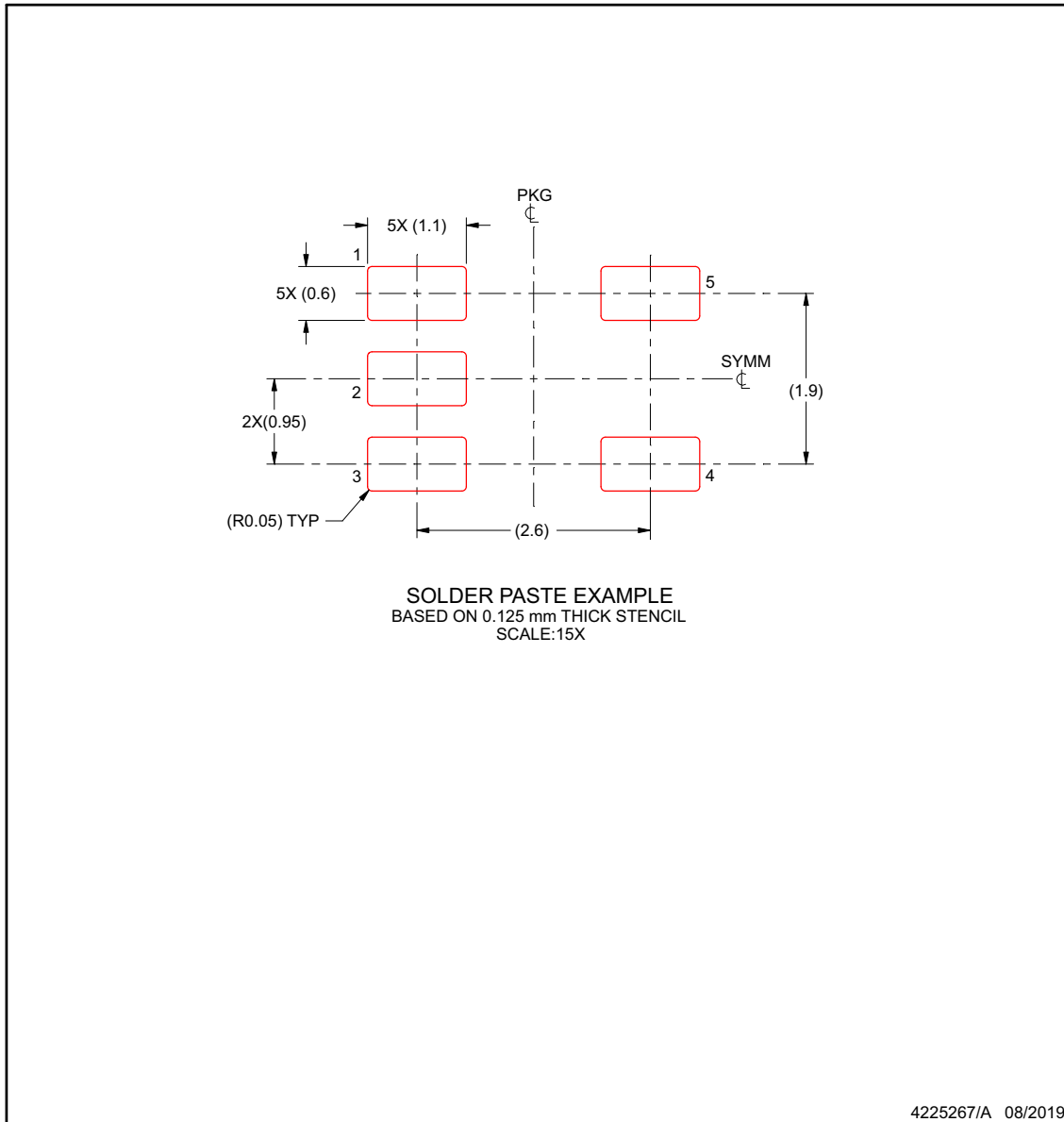

NOTES: (continued)

- 7. Laser cutting apertures with trapezoidal walls and rounded corners may offer better paste release. IPC-7525 may have alternate design recommendations.
- 8. Board assembly site may have different recommendations for stencil design.

**PACKAGING INFORMATION**

Orderable Device	Status (1)	Package Type	Package Drawing	Pins	Package Qty	Eco Plan (2)	Lead finish/ Ball material (6)	MSL Peak Temp (3)	Op Temp (°C)	Device Marking (4/5)	Samples
TMAG5110A2AQDBVR	ACTIVE	SOT-23	DBV	5	3000	RoHS & Green	SN	Level-3-260C-168 HR	-40 to 125	0A2	<a href="#">Samples</a>
TMAG5110A2AQDBVT	ACTIVE	SOT-23	DBV	5	250	RoHS & Green	SN	Level-3-260C-168 HR	-40 to 125	0A2	<a href="#">Samples</a>
TMAG5110A4AQDBVR	ACTIVE	SOT-23	DBV	5	3000	RoHS & Green	SN	Level-3-260C-168 HR	-40 to 125		<a href="#">Samples</a>
TMAG5110A4AQDBVT	ACTIVE	SOT-23	DBV	5	250	RoHS & Green	SN	Level-3-260C-168 HR	-40 to 125		<a href="#">Samples</a>
TMAG5110B2AQDBVR	ACTIVE	SOT-23	DBV	5	3000	RoHS & Green	SN	Level-3-260C-168 HR	-40 to 125	0B2	<a href="#">Samples</a>
TMAG5110B2AQDBVT	ACTIVE	SOT-23	DBV	5	250	RoHS & Green	SN	Level-3-260C-168 HR	-40 to 125	0B2	<a href="#">Samples</a>
TMAG5110B4AQDBVR	ACTIVE	SOT-23	DBV	5	3000	RoHS & Green	SN	Level-3-260C-168 HR	-40 to 125		<a href="#">Samples</a>
TMAG5110B4AQDBVT	ACTIVE	SOT-23	DBV	5	250	RoHS & Green	SN	Level-3-260C-168 HR	-40 to 125		<a href="#">Samples</a>
TMAG5110C2AQDBVR	ACTIVE	SOT-23	DBV	5	3000	RoHS & Green	SN	Level-3-260C-168 HR	-40 to 125	0C2	<a href="#">Samples</a>
TMAG5110C2AQDBVT	ACTIVE	SOT-23	DBV	5	250	RoHS & Green	SN	Level-3-260C-168 HR	-40 to 125	0C2	<a href="#">Samples</a>
TMAG5110C4AQDBVR	ACTIVE	SOT-23	DBV	5	3000	RoHS & Green	SN	Level-3-260C-168 HR	-40 to 125		<a href="#">Samples</a>
TMAG5110C4AQDBVT	ACTIVE	SOT-23	DBV	5	250	RoHS & Green	SN	Level-3-260C-168 HR	-40 to 125		<a href="#">Samples</a>
TMAG5111A2AQDBVR	ACTIVE	SOT-23	DBV	5	3000	RoHS & Green	SN	Level-3-260C-168 HR	-40 to 125	1A2	<a href="#">Samples</a>
TMAG5111A2AQDBVT	ACTIVE	SOT-23	DBV	5	250	RoHS & Green	SN	Level-3-260C-168 HR	-40 to 125	1A2	<a href="#">Samples</a>
TMAG5111A4AQDBVR	ACTIVE	SOT-23	DBV	5	3000	RoHS & Green	SN	Level-3-260C-168 HR	-40 to 125		<a href="#">Samples</a>
TMAG5111A4AQDBVT	ACTIVE	SOT-23	DBV	5	250	RoHS & Green	SN	Level-3-260C-168 HR	-40 to 125		<a href="#">Samples</a>
TMAG5111B2AQDBVR	ACTIVE	SOT-23	DBV	5	3000	RoHS & Green	SN	Level-3-260C-168 HR	-40 to 125	1B2	<a href="#">Samples</a>
TMAG5111B2AQDBVT	ACTIVE	SOT-23	DBV	5	250	RoHS & Green	SN	Level-3-260C-168 HR	-40 to 125	1B2	<a href="#">Samples</a>
TMAG5111B4AQDBVR	ACTIVE	SOT-23	DBV	5	3000	RoHS & Green	SN	Level-3-260C-168 HR	-40 to 125		<a href="#">Samples</a>
TMAG5111B4AQDBVT	ACTIVE	SOT-23	DBV	5	250	RoHS & Green	SN	Level-3-260C-168 HR	-40 to 125		<a href="#">Samples</a>

Orderable Device	Status (1)	Package Type	Package Drawing	Pins	Package Qty	Eco Plan (2)	Lead finish/ Ball material (6)	MSL Peak Temp (3)	Op Temp (°C)	Device Marking (4/5)	Samples
TMAG5111C2AQDBVR	ACTIVE	SOT-23	DBV	5	3000	RoHS & Green	SN	Level-3-260C-168 HR	-40 to 125	1C2	<a href="#">Samples</a>
TMAG5111C2AQDBVT	ACTIVE	SOT-23	DBV	5	250	RoHS & Green	SN	Level-3-260C-168 HR	-40 to 125	1C2	<a href="#">Samples</a>
TMAG5111C4AQDBVR	ACTIVE	SOT-23	DBV	5	3000	RoHS & Green	SN	Level-3-260C-168 HR	-40 to 125		<a href="#">Samples</a>
TMAG5111C4AQDBVT	ACTIVE	SOT-23	DBV	5	250	RoHS & Green	SN	Level-3-260C-168 HR	-40 to 125		<a href="#">Samples</a>

(1) The marketing status values are defined as follows:

**ACTIVE:** Product device recommended for new designs.

**LIFEBUY:** TI has announced that the device will be discontinued, and a lifetime-buy period is in effect.

**NRND:** Not recommended for new designs. Device is in production to support existing customers, but TI does not recommend using this part in a new design.

**PREVIEW:** Device has been announced but is not in production. Samples may or may not be available.

**OBSELETE:** TI has discontinued the production of the device.

(2) **RoHS:** TI defines "RoHS" to mean semiconductor products that are compliant with the current EU RoHS requirements for all 10 RoHS substances, including the requirement that RoHS substance do not exceed 0.1% by weight in homogeneous materials. Where designed to be soldered at high temperatures, "RoHS" products are suitable for use in specified lead-free processes. TI may reference these types of products as "Pb-Free".

**RoHS Exempt:** TI defines "RoHS Exempt" to mean products that contain lead but are compliant with EU RoHS pursuant to a specific EU RoHS exemption.

**Green:** TI defines "Green" to mean the content of Chlorine (Cl) and Bromine (Br) based flame retardants meet JS709B low halogen requirements of <=1000ppm threshold. Antimony trioxide based flame retardants must also meet the <=1000ppm threshold requirement.

(3) MSL, Peak Temp. - The Moisture Sensitivity Level rating according to the JEDEC industry standard classifications, and peak solder temperature.

(4) There may be additional marking, which relates to the logo, the lot trace code information, or the environmental category on the device.

(5) Multiple Device Markings will be inside parentheses. Only one Device Marking contained in parentheses and separated by a "~" will appear on a device. If a line is indented then it is a continuation of the previous line and the two combined represent the entire Device Marking for that device.

(6) Lead finish/Ball material - Orderable Devices may have multiple material finish options. Finish options are separated by a vertical ruled line. Lead finish/Ball material values may wrap to two lines if the finish value exceeds the maximum column width.

**Important Information and Disclaimer:** The information provided on this page represents TI's knowledge and belief as of the date that it is provided. TI bases its knowledge and belief on information provided by third parties, and makes no representation or warranty as to the accuracy of such information. Efforts are underway to better integrate information from third parties. TI has taken and continues to take reasonable steps to provide representative and accurate information but may not have conducted destructive testing or chemical analysis on incoming materials and chemicals. TI and TI suppliers consider certain information to be proprietary, and thus CAS numbers and other limited information may not be available for release.

In no event shall TI's liability arising out of such information exceed the total purchase price of the TI part(s) at issue in this document sold by TI to Customer on an annual basis.

**OTHER QUALIFIED VERSIONS OF TMAG5110, TMAG5111 :**

- Automotive : [TMAG5110-Q1](#), [TMAG5111-Q1](#)

NOTE: Qualified Version Definitions:

- Automotive - Q100 devices qualified for high-reliability automotive applications targeting zero defects



**TAPE AND REEL INFORMATION**

**QUADRANT ASSIGNMENTS FOR PIN 1 ORIENTATION IN TAPE**

\*All dimensions are nominal

Device	Package Type	Package Drawing	Pins	SPQ	Reel Diameter (mm)	Reel Width W1 (mm)	A0 (mm)	B0 (mm)	K0 (mm)	P1 (mm)	W (mm)	Pin1 Quadrant
TMAG5110A2AQDBVR	SOT-23	DBV	5	3000	178.0	9.0	3.3	3.2	1.4	4.0	8.0	Q3
TMAG5110A2AQDBVT	SOT-23	DBV	5	250	178.0	9.0	3.3	3.2	1.4	4.0	8.0	Q3
TMAG5110A4AQDBVR	SOT-23	DBV	5	3000	178.0	9.0	3.3	3.2	1.4	4.0	8.0	Q3
TMAG5110A4AQDBVT	SOT-23	DBV	5	250	178.0	9.0	3.3	3.2	1.4	4.0	8.0	Q3
TMAG5110B2AQDBVR	SOT-23	DBV	5	3000	178.0	9.0	3.3	3.2	1.4	4.0	8.0	Q3
TMAG5110B2AQDBVT	SOT-23	DBV	5	250	178.0	9.0	3.3	3.2	1.4	4.0	8.0	Q3
TMAG5110B4AQDBVR	SOT-23	DBV	5	3000	178.0	9.0	3.3	3.2	1.4	4.0	8.0	Q3
TMAG5110B4AQDBVT	SOT-23	DBV	5	250	178.0	9.0	3.3	3.2	1.4	4.0	8.0	Q3
TMAG5110C2AQDBVR	SOT-23	DBV	5	3000	178.0	9.0	3.3	3.2	1.4	4.0	8.0	Q3
TMAG5110C2AQDBVT	SOT-23	DBV	5	250	178.0	9.0	3.3	3.2	1.4	4.0	8.0	Q3
TMAG5110C4AQDBVR	SOT-23	DBV	5	3000	178.0	9.0	3.3	3.2	1.4	4.0	8.0	Q3
TMAG5110C4AQDBVT	SOT-23	DBV	5	250	178.0	9.0	3.3	3.2	1.4	4.0	8.0	Q3
TMAG5111A2AQDBVR	SOT-23	DBV	5	3000	178.0	9.0	3.3	3.2	1.4	4.0	8.0	Q3
TMAG5111A2AQDBVT	SOT-23	DBV	5	250	178.0	9.0	3.3	3.2	1.4	4.0	8.0	Q3
TMAG5111A4AQDBVR	SOT-23	DBV	5	3000	178.0	9.0	3.3	3.2	1.4	4.0	8.0	Q3
TMAG5111A4AQDBVT	SOT-23	DBV	5	250	178.0	9.0	3.3	3.2	1.4	4.0	8.0	Q3
TMAG5111B2AQDBVR	SOT-23	DBV	5	3000	178.0	9.0	3.3	3.2	1.4	4.0	8.0	Q3
TMAG5111B2AQDBVT	SOT-23	DBV	5	250	178.0	9.0	3.3	3.2	1.4	4.0	8.0	Q3

Device	Package Type	Package Drawing	Pins	SPQ	Reel Diameter (mm)	Reel Width W1 (mm)	A0 (mm)	B0 (mm)	K0 (mm)	P1 (mm)	W (mm)	Pin1 Quadrant
TMAG5111B4AQDBVR	SOT-23	DBV	5	3000	178.0	9.0	3.3	3.2	1.4	4.0	8.0	Q3
TMAG5111B4AQDBVT	SOT-23	DBV	5	250	178.0	9.0	3.3	3.2	1.4	4.0	8.0	Q3
TMAG5111C2AQDBVR	SOT-23	DBV	5	3000	178.0	9.0	3.3	3.2	1.4	4.0	8.0	Q3
TMAG5111C2AQDBVT	SOT-23	DBV	5	250	178.0	9.0	3.3	3.2	1.4	4.0	8.0	Q3
TMAG5111C4AQDBVR	SOT-23	DBV	5	3000	178.0	9.0	3.3	3.2	1.4	4.0	8.0	Q3
TMAG5111C4AQDBVT	SOT-23	DBV	5	250	178.0	9.0	3.3	3.2	1.4	4.0	8.0	Q3

**TAPE AND REEL BOX DIMENSIONS**

\*All dimensions are nominal

Device	Package Type	Package Drawing	Pins	SPQ	Length (mm)	Width (mm)	Height (mm)
TMAG5110A2AQDBVR	SOT-23	DBV	5	3000	190.0	190.0	30.0
TMAG5110A2AQDBVT	SOT-23	DBV	5	250	190.0	190.0	30.0
TMAG5110A4AQDBVR	SOT-23	DBV	5	3000	190.0	190.0	30.0
TMAG5110A4AQDBVT	SOT-23	DBV	5	250	190.0	190.0	30.0
TMAG5110B2AQDBVR	SOT-23	DBV	5	3000	190.0	190.0	30.0
TMAG5110B2AQDBVT	SOT-23	DBV	5	250	190.0	190.0	30.0
TMAG5110B4AQDBVR	SOT-23	DBV	5	3000	190.0	190.0	30.0
TMAG5110B4AQDBVT	SOT-23	DBV	5	250	190.0	190.0	30.0
TMAG5110C2AQDBVR	SOT-23	DBV	5	3000	190.0	190.0	30.0
TMAG5110C2AQDBVT	SOT-23	DBV	5	250	190.0	190.0	30.0
TMAG5110C4AQDBVR	SOT-23	DBV	5	3000	190.0	190.0	30.0

Device	Package Type	Package Drawing	Pins	SPQ	Length (mm)	Width (mm)	Height (mm)
TMAG5110C4AQDBVT	SOT-23	DBV	5	250	190.0	190.0	30.0
TMAG5111A2AQDBVR	SOT-23	DBV	5	3000	190.0	190.0	30.0
TMAG5111A2AQDBVT	SOT-23	DBV	5	250	190.0	190.0	30.0
TMAG5111A4AQDBVR	SOT-23	DBV	5	3000	190.0	190.0	30.0
TMAG5111A4AQDBVT	SOT-23	DBV	5	250	190.0	190.0	30.0
TMAG5111B2AQDBVR	SOT-23	DBV	5	3000	190.0	190.0	30.0
TMAG5111B2AQDBVT	SOT-23	DBV	5	250	190.0	190.0	30.0
TMAG5111B4AQDBVR	SOT-23	DBV	5	3000	190.0	190.0	30.0
TMAG5111B4AQDBVT	SOT-23	DBV	5	250	190.0	190.0	30.0
TMAG5111C2AQDBVR	SOT-23	DBV	5	3000	190.0	190.0	30.0
TMAG5111C2AQDBVT	SOT-23	DBV	5	250	190.0	190.0	30.0
TMAG5111C4AQDBVR	SOT-23	DBV	5	3000	190.0	190.0	30.0
TMAG5111C4AQDBVT	SOT-23	DBV	5	250	190.0	190.0	30.0

## IMPORTANT NOTICE AND DISCLAIMER

TI PROVIDES TECHNICAL AND RELIABILITY DATA (INCLUDING DATA SHEETS), DESIGN RESOURCES (INCLUDING REFERENCE DESIGNS), APPLICATION OR OTHER DESIGN ADVICE, WEB TOOLS, SAFETY INFORMATION, AND OTHER RESOURCES "AS IS" AND WITH ALL FAULTS, AND DISCLAIMS ALL WARRANTIES, EXPRESS AND IMPLIED, INCLUDING WITHOUT LIMITATION ANY IMPLIED WARRANTIES OF MERCHANTABILITY, FITNESS FOR A PARTICULAR PURPOSE OR NON-INFRINGEMENT OF THIRD PARTY INTELLECTUAL PROPERTY RIGHTS.

These resources are intended for skilled developers designing with TI products. You are solely responsible for (1) selecting the appropriate TI products for your application, (2) designing, validating and testing your application, and (3) ensuring your application meets applicable standards, and any other safety, security, regulatory or other requirements.

These resources are subject to change without notice. TI grants you permission to use these resources only for development of an application that uses the TI products described in the resource. Other reproduction and display of these resources is prohibited. No license is granted to any other TI intellectual property right or to any third party intellectual property right. TI disclaims responsibility for, and you will fully indemnify TI and its representatives against, any claims, damages, costs, losses, and liabilities arising out of your use of these resources.

TI's products are provided subject to [TI's Terms of Sale](#) or other applicable terms available either on [ti.com](http://ti.com) or provided in conjunction with such TI products. TI's provision of these resources does not expand or otherwise alter TI's applicable warranties or warranty disclaimers for TI products.

TI objects to and rejects any additional or different terms you may have proposed.

Mailing Address: Texas Instruments, Post Office Box 655303, Dallas, Texas 75265  
Copyright © 2022, Texas Instruments Incorporated