

## SPECIFICATION

Part No. : **GW26.0152**

Product Name : 2.4GHz Miniature Screw mount Monopole  
Antenna

Feature : RP-SMA(M)  
Fixed 90°  
ROHS Compliant



## 1 Introduction

The GW.26 2.4 GHz Monopole RP-SMA(M) antenna is ideal for 2.4 GHz wireless applications such as Bluetooth and Wireless LAN. Connector mount is fully customizable.

## 2 Specification

Wi-Fi 2.4GHz	
Frequency	2400~2500MHz
Bandwidth	1000MHz
Peak Gain	> 0dBi
Radiation Efficiency	> 40%
Radiation	Omni-directional
Polarization	Vertical
Power Handling 1W Max	Power Handling 1W Max
Electrical Wave	Monopole
Impedance	50Ω
Operating Temperature	-40°C ~ +85°C
Storage Temperature	-40°C ~ +85°C

## 3 Mechanical Properties

Mechanical Properties	
Colour	Black and Green
Connector	RP-SMA(M) R/A
IP rating	IP-65

# 4 Antenna Characteristics

## 4.1 Antenna S11

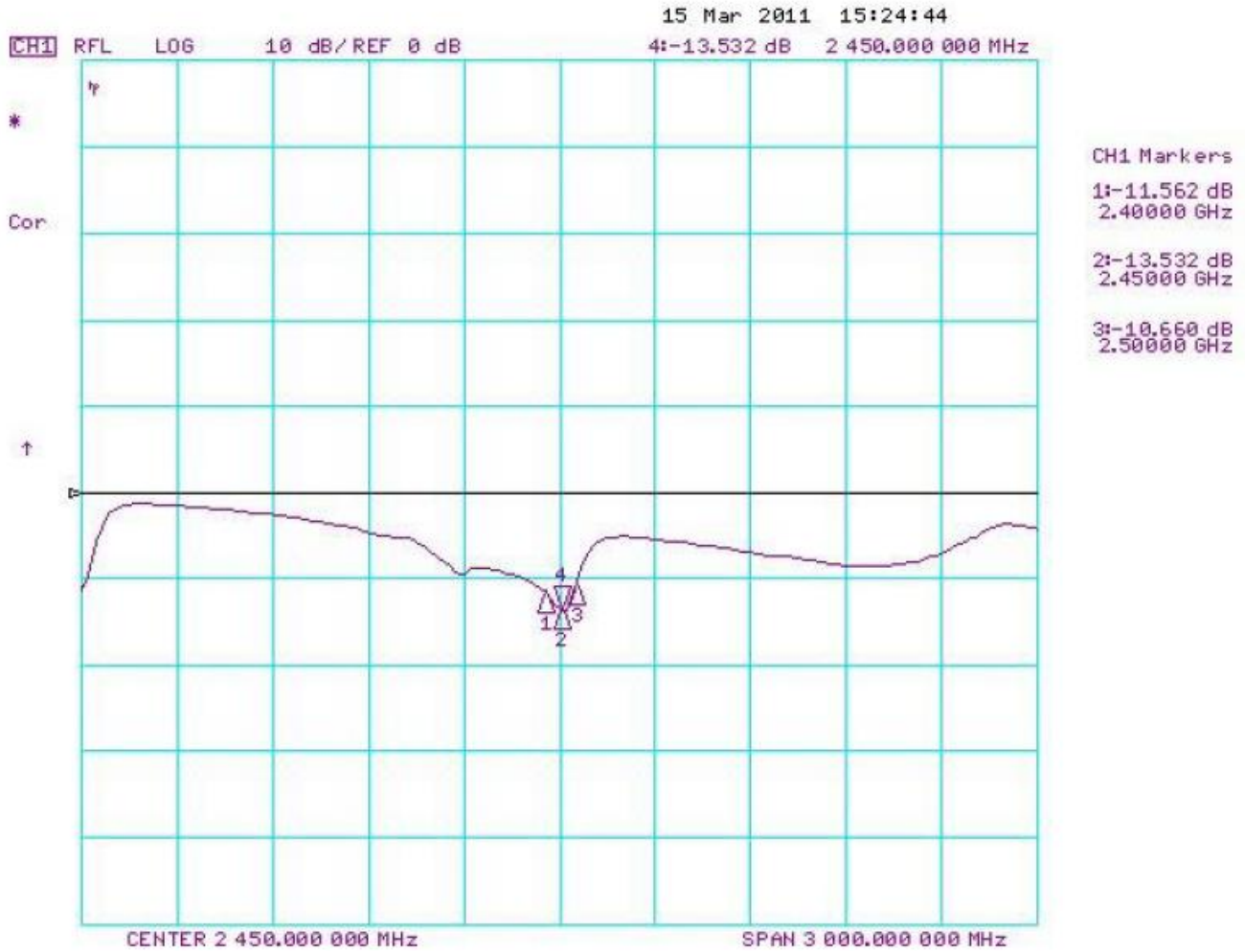

## 4.2 Antenna Peak Gain

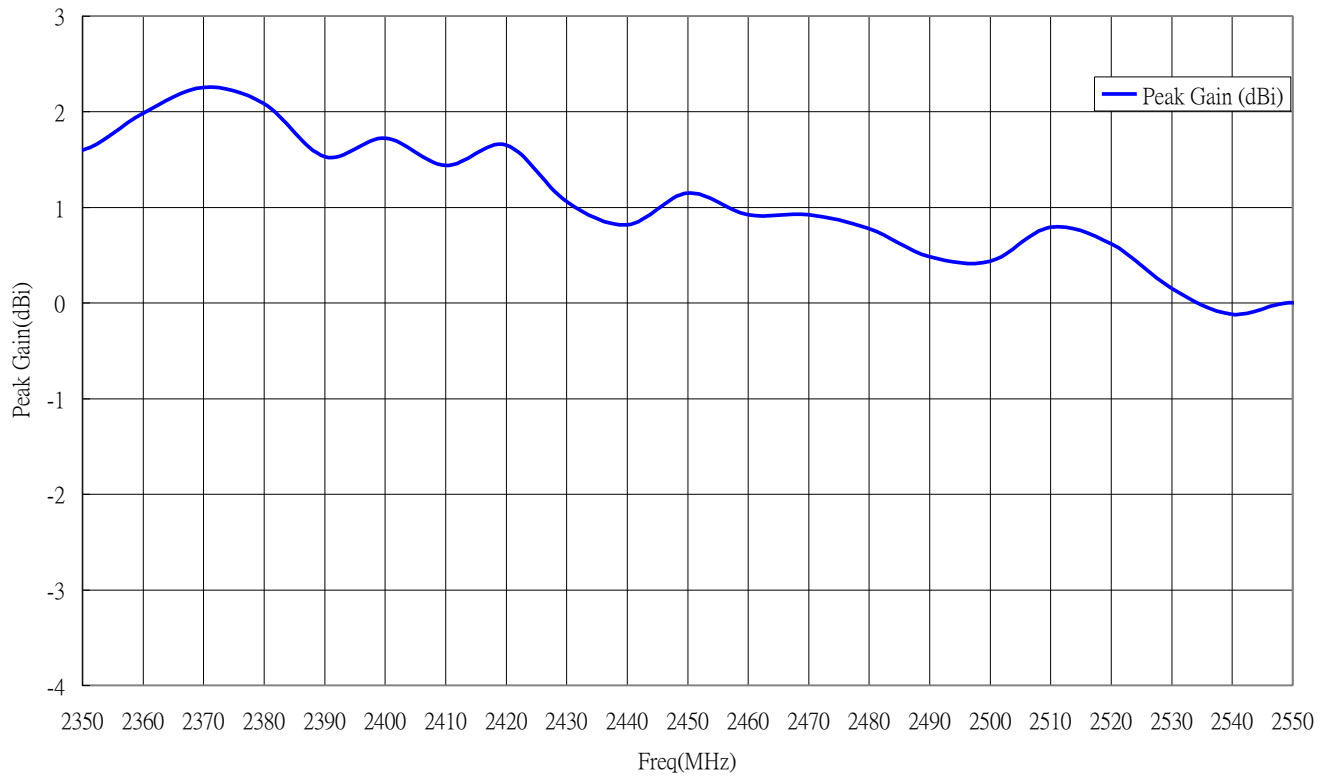

### 4.3 Antenna Efficiency

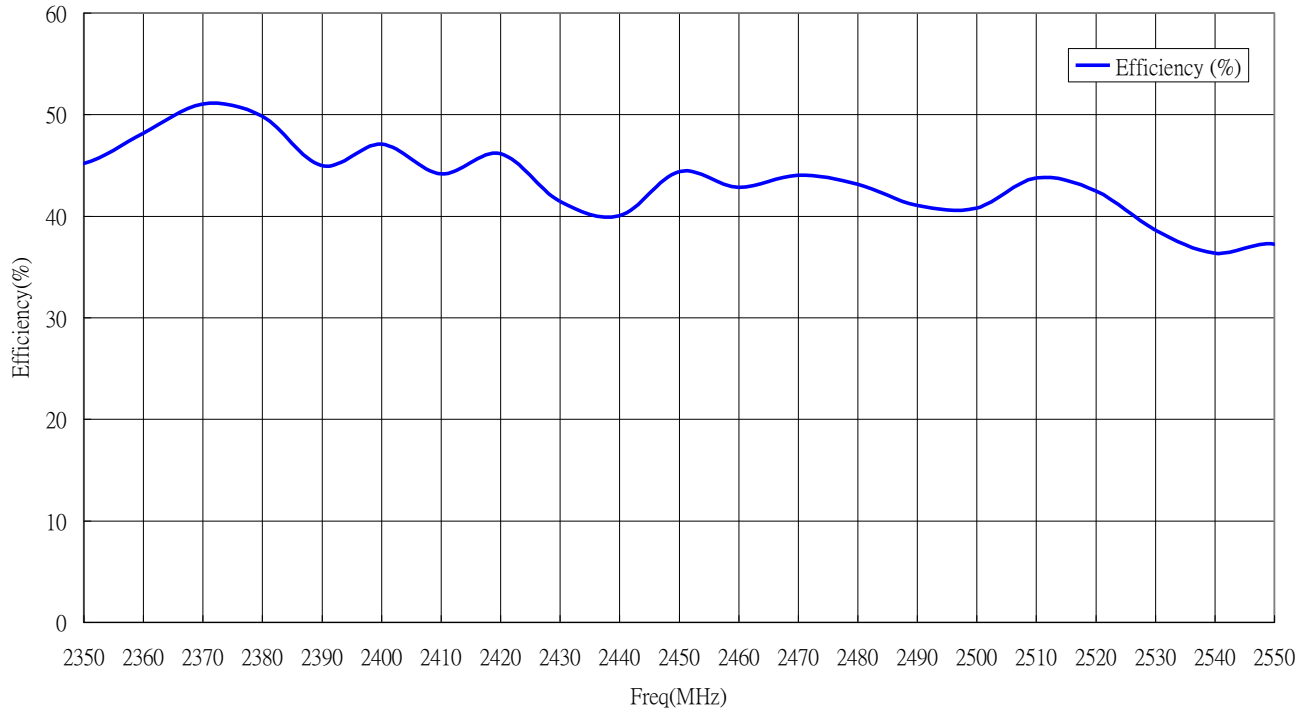

#### 4.4 Antenna pattern (XY plane)

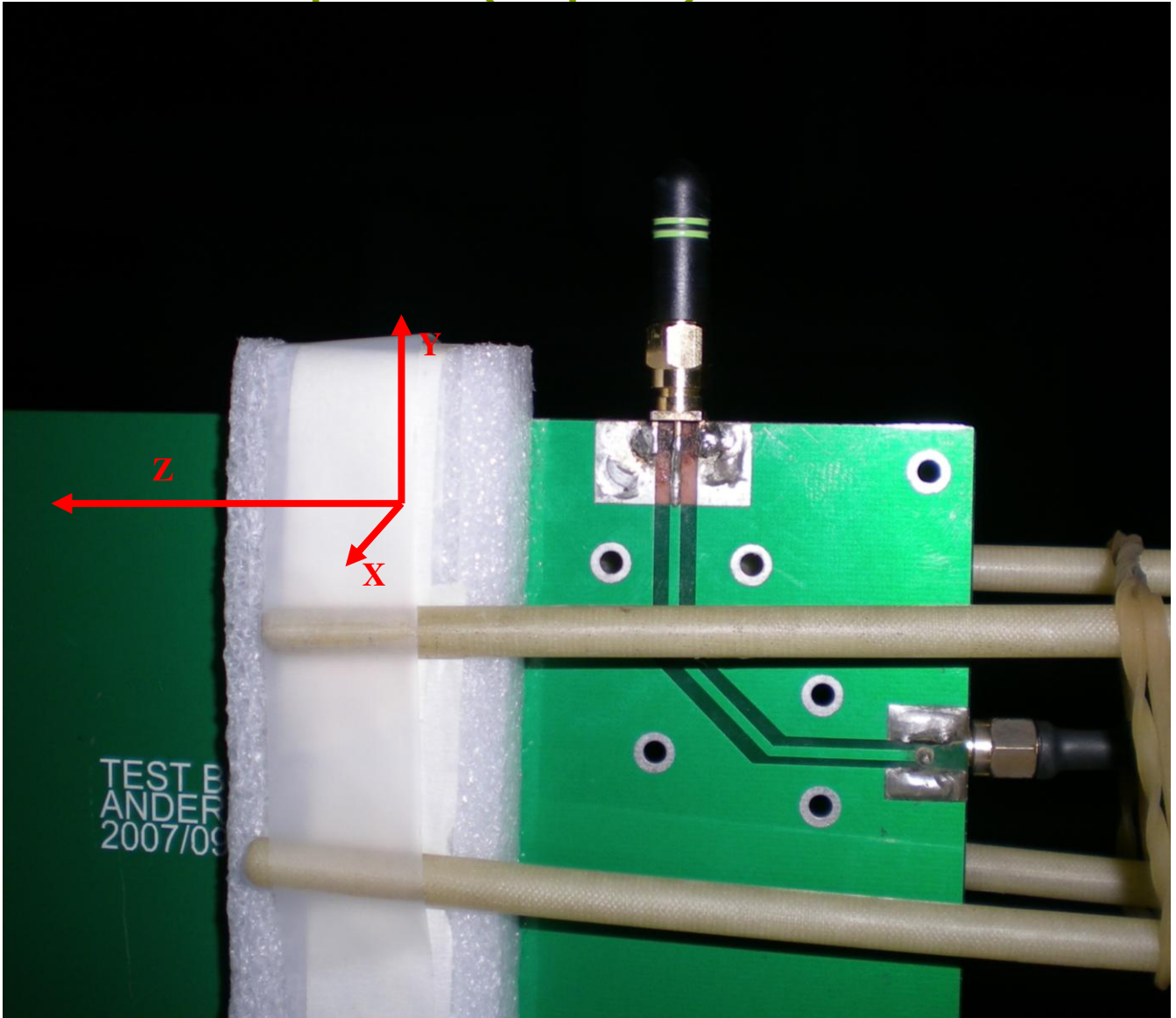

## 4.5 Antenna pattern (XY plane)

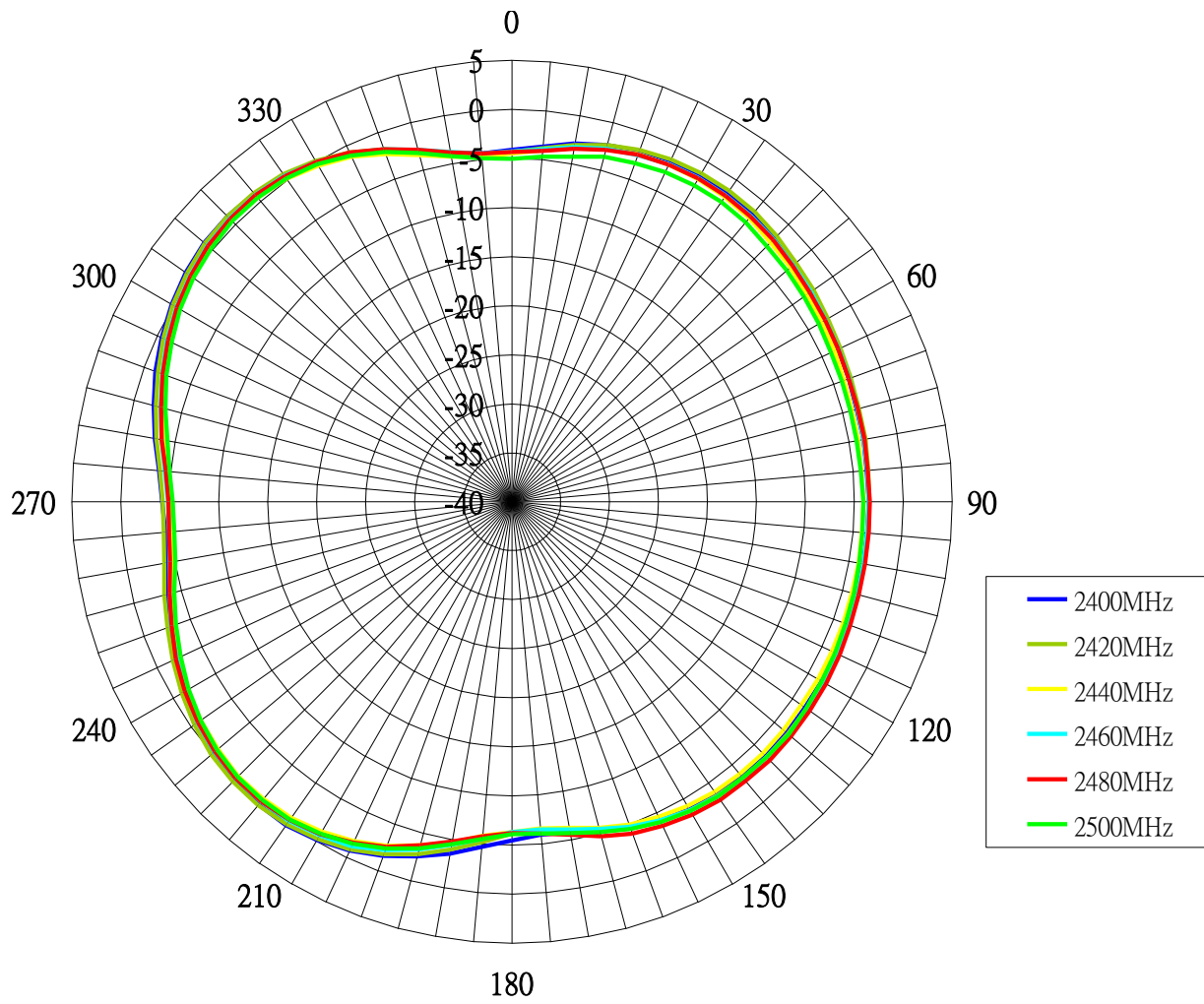

## 4.6 Antenna pattern (XZ plane)

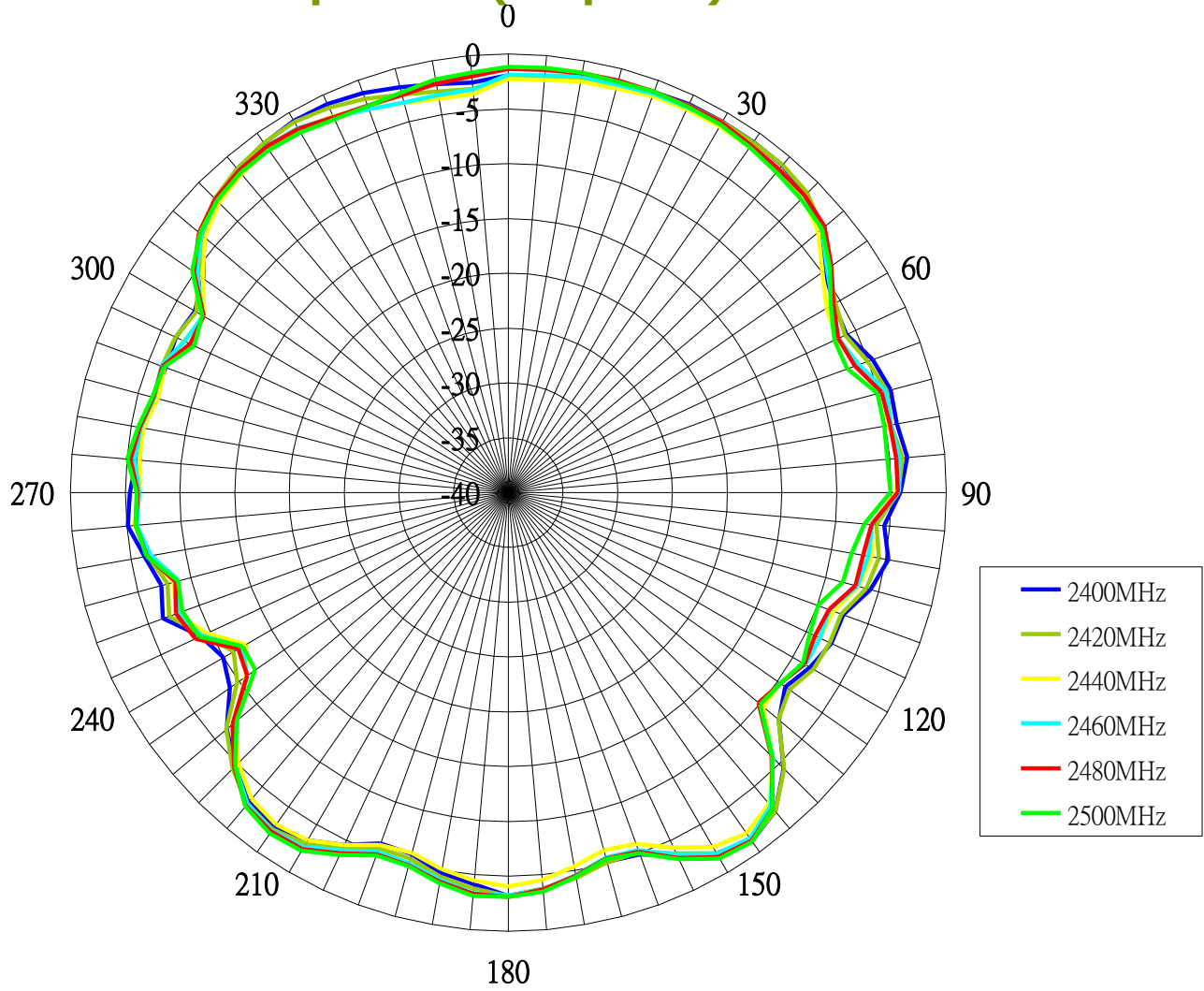



### 4.7 Antenna pattern (YZ plane)

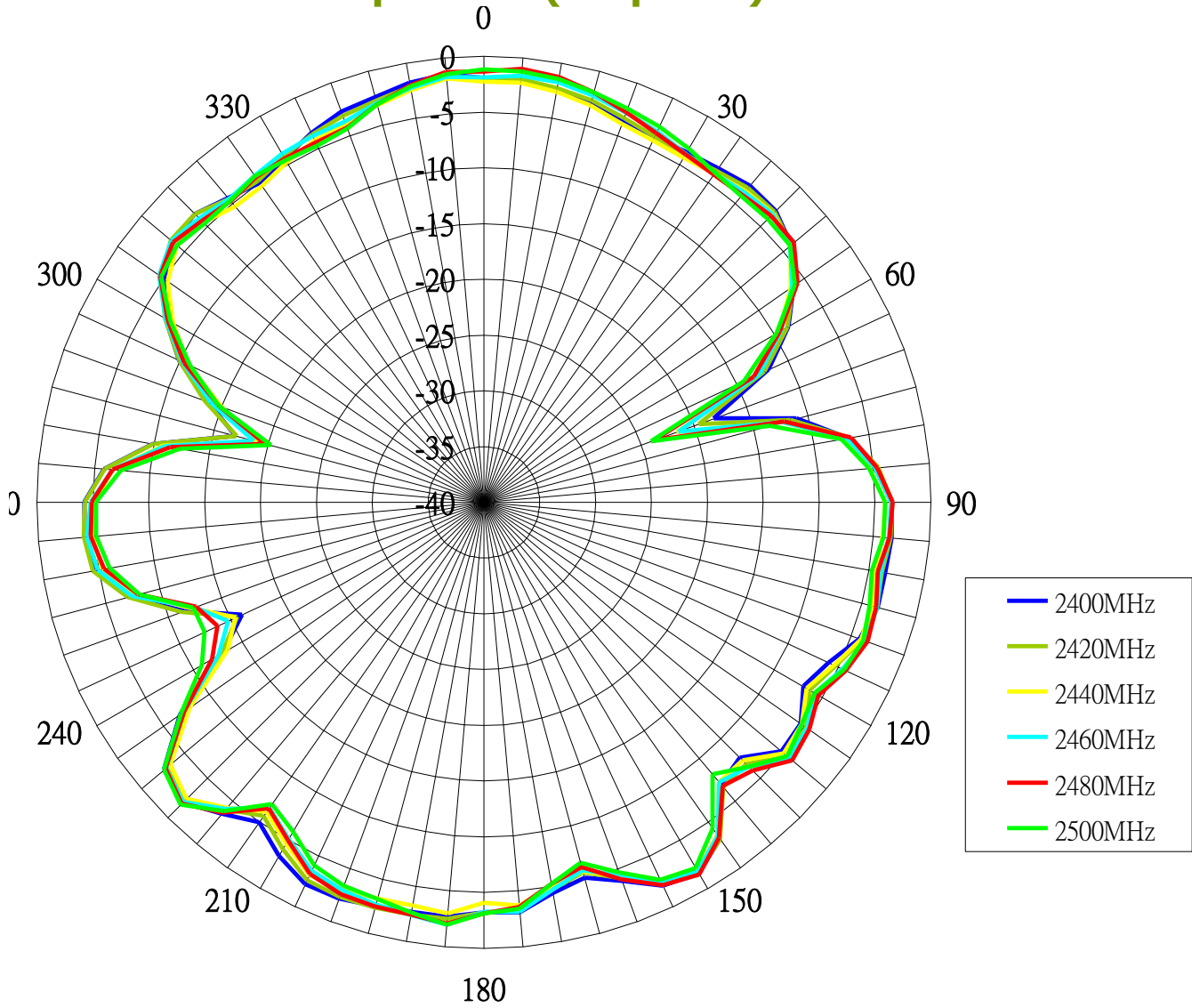

## 5. Outline Drawings and Structure

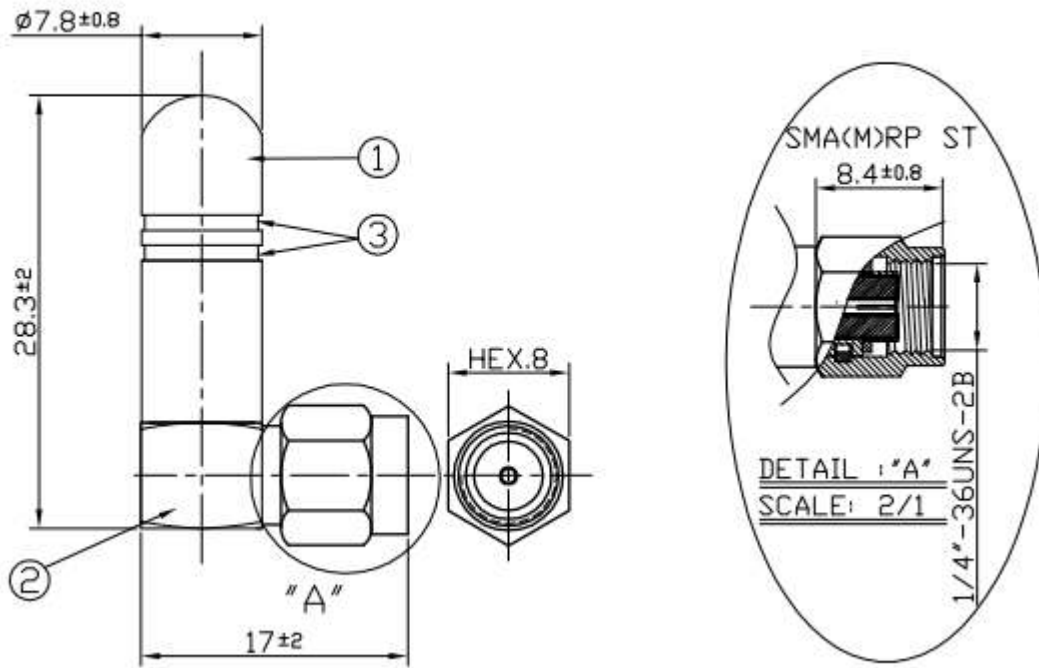

### Key

1	Antenna Cover	TPU(Black)
2	Connector	RP-SMA(M)
3	Colour Stripes	Apple Green