

# SN74GTLP2034

## 8-BIT LVTTTL-TO-GTLP ADJUSTABLE-EDGE-RATE REGISTERED TRANSCEIVER WITH SPLIT LVTTTL PORT AND FEEDBACK PATH

SCES353C – JUNE 2001 – REVISED SEPTEMBER 2001

- Member of the Texas Instruments Widebus™ Family
- TI-OPC™ Circuitry Limits Ringing on Unevenly Loaded Backplanes
- OEC™ Circuitry Improves Signal Integrity and Reduces Electromagnetic Interference
- Bidirectional Interface Between GTLP Signal Levels and LVTTTL Logic Levels
- Split LVTTTL Port Provides a Feedback Path for Control and Diagnostics Monitoring
- LVTTTL Interfaces Are 5-V Tolerant
- High-Drive GTLP Open-Drain Outputs (100 mA)
- LVTTTL Outputs (–24 mA/24 mA)
- Variable Edge-Rate Control (ERC) Input Selects GTLP Rise and Fall Times for Optimal Data-Transfer Rate and Signal Integrity in Distributed Loads
- I<sub>off</sub>, Power-Up 3-State, and BIAS V<sub>CC</sub> Support Live Insertion
- Distributed V<sub>CC</sub> and GND Pins Minimize High-Speed Switching Noise
- Latch-Up Performance Exceeds 100 mA Per JESD 78, Class II
- ESD Protection Exceeds JESD 22
  - 2000-V Human-Body Model (A114-A)
  - 200-V Machine Model (A115-A)
  - 1000-V Charged-Device Model (C101)

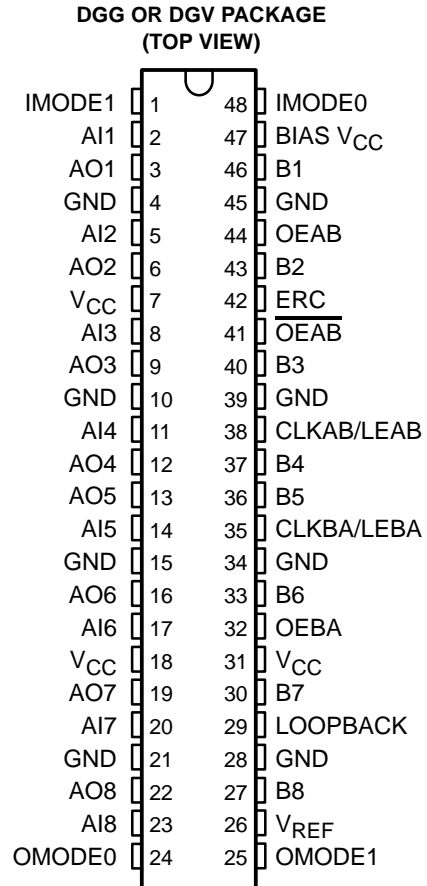

### description

The SN74GTLP2034 is a high-drive, 8-bit, three-wire registered transceiver that provides true LVTTTL-to-GTLP and GTLP-to-LVTTTL signal-level translation. The device allows for transparent, latched, and flip-flop modes of data transfer with separate LVTTTL input and LVTTTL output pins, which provides a feedback path for control and diagnostics monitoring, the same functionality as the SN74FB2033, but with true logic. The device provides a high-speed interface between cards operating at LVTTTL logic levels and a backplane operating at GTLP signal levels. High-speed (about three times faster than standard LVTTTL or TTL) backplane operation is a direct result of GTLP's reduced output swing (<1 V), reduced input threshold levels, improved differential input, OEC™ circuitry, and TI-OPC™ circuitry. Improved GTLP OEC and TI-OPC circuits minimize bus-settling time and have been designed and tested using several backplane models. The high drive allows incident-wave switching in heavily loaded backplanes with equivalent load impedance down to 11 Ω.



Please be aware that an important notice concerning availability, standard warranty, and use in critical applications of Texas Instruments semiconductor products and disclaimers thereto appears at the end of this data sheet.

OEC, TI-OPC, and Widebus are trademarks of Texas Instruments.

PRODUCTION DATA information is current as of publication date. Products conform to specifications per the terms of Texas Instruments standard warranty. Production processing does not necessarily include testing of all parameters.



POST OFFICE BOX 655303 • DALLAS, TEXAS 75265

Copyright © 2001, Texas Instruments Incorporated

# SN74GTLP2034

## 8-BIT LVTTTL-TO-GTLP ADJUSTABLE-EDGE-RATE REGISTERED TRANSCEIVER WITH SPLIT LVTTTL PORT AND FEEDBACK PATH

SCES353C – JUNE 2001 – REVISED SEPTEMBER 2001

### description (continued)

GTLP is the Texas Instruments derivative of the Gunning Transceiver Logic (GTL) JEDEC standard JESD 8-3. The ac specification of the SN74GTLP2034 is given only at the preferred higher noise-margin GTLP, but the user has the flexibility of using this device at either GTL ( $V_{TT} = 1.2\text{ V}$  and  $V_{REF} = 0.8\text{ V}$ ) or GTLP ( $V_{TT} = 1.5\text{ V}$  and  $V_{REF} = 1\text{ V}$ ) signal levels. For information on using GTLP devices in FB+/BTL applications, refer to TI application reports, *Texas Instruments GTLP Frequently Asked Questions*, literature number SCEA019, and *GTLP in BTL Applications*, literature number SCEA017.

Normally, the B port operates at GTLP signal levels. The A-port and control inputs operate at LVTTTL logic levels, but are 5-V tolerant and can be directly driven by TTL or 5-V CMOS devices.  $V_{REF}$  is the B-port differential input reference voltage.

This device is fully specified for live-insertion applications using  $I_{off}$ , power-up 3-state, and BIAS  $V_{CC}$ . The  $I_{off}$  circuitry disables the outputs, preventing damaging current backflow through the device when it is powered down. The power-up 3-state circuitry places the outputs in the high-impedance state during power up and power down, which prevents driver conflict. The BIAS  $V_{CC}$  circuitry precharges and preconditions the B-port input/output connections, preventing disturbance of active data on the backplane during card insertion or removal, and permits true live-insertion capability.

This GTLP device features TI-OPC circuitry, which actively limits overshoot caused by improperly terminated backplanes, unevenly distributed cards, or empty slots during low-to-high signal transitions. This improves signal integrity, which allows adequate noise margin to be maintained at higher frequencies.

High-drive GTLP backplane interface devices feature adjustable edge-rate control (ERC). Changing the ERC input voltage between low and high adjusts the B-port output rise and fall times. This allows the designer to optimize system data-transfer rate and signal integrity to the backplane load.

When  $V_{CC}$  is between 0 and 1.5 V, the device is in the high-impedance state during power up or power down. However, to ensure the high-impedance state above 1.5 V,  $\overline{OEAB}$  should be tied to  $V_{CC}$  through a pullup resistor and OEAB and OEBA should be tied to GND through a pulldown resistor; the minimum value of the resistor is determined by the current-sinking/current-sourcing capability of the driver.

**GQL PACKAGE  
(TOP VIEW)**

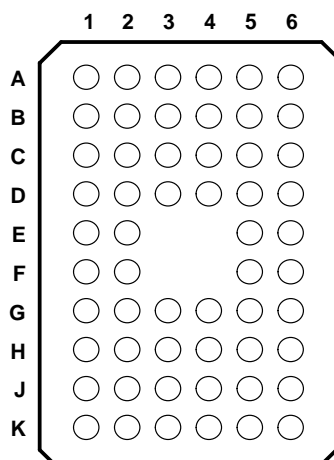

### terminal assignments

	1	2	3	4	5	6
A	IMODE1	NC	NC	NC	NC	IMODE0
B	AO1	AI1	GND	GND	BIAS $V_{CC}$	B1
C	AO2	AI2	$V_{CC}$	ERC	OEAB	B2
D	AO3	AI3	GND	GND	$\overline{OEAB}$	B3
E	AO4	AI4			CLKAB/LEAB	B4
F	AO5	AI5			CLKBA/LEBA	B5
G	AO6	AI6	GND	GND	OEBA	B6
H	AO7	AI7	$V_{CC}$	$V_{CC}$	LOOPBACK	B7
J	AO8	AI8	GND	GND	$V_{REF}$	B8
K	OMODE0	NC	NC	NC	NC	OMODE1

NC = No internal connection



**SN74GTLP2034**

**8-BIT LVTTTL-TO-GTLP ADJUSTABLE-EDGE-RATE REGISTERED TRANSCEIVER  
WITH SPLIT LVTTTL PORT AND FEEDBACK PATH**

SCES353C – JUNE 2001 – REVISED SEPTEMBER 2001

**ORDERING INFORMATION**

T <sub>A</sub>	PACKAGE†		ORDERABLE PART NUMBER	TOP-SIDE MARKING
–40°C to 85°C	TSSOP – DGG	Tape and reel	SN74GTLP2034DGGR	GTLP2034
	TVSOP – DGV	Tape and reel	SN74GTLP2034DGVR	GT2034
	VFBGA – GQL	Tape and reel	SN74GTLP2034GQLR	GR034

† Package drawings, standard packing quantities, thermal data, symbolization, and PCB design guidelines are available at [www.ti.com/sc/package](http://www.ti.com/sc/package).

**functional description**

The SN74GTLP2034 is a high-drive (100 mA), 8-bit, three-wire registered transceiver containing D-type latches and D-type flip-flops for data-path operation in the transparent, latched, or flip-flop modes. Data transmission is true, with AI data going to the B port and B data going to AO. The split LVTTTL AI and AO provides a feedback path for control and diagnostics monitoring.

The logic element for data flow in each direction is configured by two mode (IMODE1 and IMODE0 for B to A, OMODE1 and OMODE0 for A to B) inputs as a buffer, D-type flip-flop, or D-type latch. When configured in the buffer mode, the input data appears at the output port. In the flip-flop mode, data is stored on the rising edge of the appropriate clock (CLKAB/LEAB or CLKBA/LEBA) input. In the latch mode, the clock inputs serve as active-high transparent latch enables.

Data flow in the B-to-A direction, regardless of the logic element selected, is further controlled by the LOOPBACK input. When LOOPBACK is low, B-port data is the B-to-A input. When LOOPBACK is high, the output of the selected A-to-B logic element is the B-to-A input.

The AO enable/disable control is provided by OEBA. When OEBA is low or when V<sub>CC</sub> is less than 1.5 V, AO is in the high-impedance state. When OEBA is high, AO is active (high or low logic levels).

The B port is controlled by OEAB and  $\overline{\text{OEAB}}$ . If OEAB is low,  $\overline{\text{OEAB}}$  is high, or V<sub>CC</sub> is less than 1.5 V, the B port is inactive. If OEAB is high and  $\overline{\text{OEAB}}$  is low, the B port is active.

The A-to-B and B-to-A logic elements are active, regardless of the state of their associated outputs. The logic elements can enter new data (in flip-flop and latch modes) or retain previously stored data while the associated outputs are in the high-impedance (AO) or inactive (B port) states.



**8-BIT LVTTTL-TO-GTLP ADJUSTABLE-EDGE-RATE REGISTERED TRANSCEIVER WITH SPLIT LVTTTL PORT AND FEEDBACK PATH**

SCES353C – JUNE 2001 – REVISED SEPTEMBER 2001

**Function Tables**

**FUNCTION/MODE**

INPUTS								OUTPUT	MODE
OEBA	OEAB	$\overline{OEAB}$	OMODE1	OMODE0	IMODE1	IMODE0	LOOPBACK		
L	L	X	X	X	X	X	X	Z	Isolation
L	X	H	X	X	X	X	X	Z	Isolation
X	H	L	L	L	X	X	X	AI to B	Buffer
X	H	L	L	H	X	X	X	AI to B	Flip-flop
X	H	L	H	X	X	X	X	AI to B	Latch
H	L	X	X	X	L	L	L	B to AO	Buffer
H	X	H	X	X	L	L	L	B to AO	Buffer
H	L	X	X	X	L	H	L	B to AO	Flip-flop
H	X	H	X	X	L	H	L	B to AO	Flip-flop
H	L	X	X	X	H	X	L	B to AO	Latch
H	X	H	X	X	H	X	L	B to AO	Latch
H	L	X	X	X	L	L	H	AI to AO	Buffer
H	X	H	X	X	L	L	H	AI to AO	Buffer
H	L	X	X	X	L	H	H	AI to AO	Flip-flop
H	X	H	X	X	L	H	H	AI to AO	Flip-flop
H	L	X	X	X	H	X	H	AI to AO	Latch
H	X	H	X	X	H	X	H	AI to AO	Latch
H	H	L	X	X	X	X	L	AI to B, B to AO	Transparent with feedback path

**ENABLE/DISABLE**

INPUTS			OUTPUTS	
OEBA	OEAB	$\overline{OEAB}$	AO	B
L	X	X	Z	
H	X	X	Active	
X	L	L		Z
X	L	H		Z
X	H	L		Active
X	H	H		Z

**BUFFER**

INPUT	OUTPUT
L	L
H	H

**LATCH**

INPUTS		OUTPUT
CLK/LE	DATA	
H	L	L
H	H	H
L	X	Q <sub>0</sub>



SN74GTLP2034

**8-BIT LVTTTL-TO-GTLP ADJUSTABLE-EDGE-RATE REGISTERED TRANSCEIVER  
WITH SPLIT LVTTTL PORT AND FEEDBACK PATH**

SCES353C – JUNE 2001 – REVISED SEPTEMBER 2001

**Function Tables (Continued)**

**LOOPBACK**

LOOPBACK	Q†
L	B port
H	Point P‡

† Q is the input to the B-to-A logic element.

‡ P is the output of the A-to-B logic element (see functional block diagram).

**SELECT**

INPUTS		SELECTED LOGIC ELEMENT
MODE1	MODE0	
L	L	Buffer
L	H	Flip-flop
H	X	Latch

**FLIP-FLOP**

INPUTS		OUTPUT
CLK/LE	DATA	
L	X	Q <sub>0</sub>
↑	L	L
↑	H	H

**B-PORT EDGE-RATE CONTROL (ERC)**

INPUT ERC	OUTPUT B-PORT EDGE RATE
LOGIC LEVEL	
H	Slow
L	Fast

# SN74GTLP2034

## 8-BIT LVTTTL-TO-GTLP ADJUSTABLE-EDGE-RATE REGISTERED TRANSCEIVER WITH SPLIT LVTTTL PORT AND FEEDBACK PATH

SCES353C – JUNE 2001 – REVISED SEPTEMBER 2001

### functional block diagram

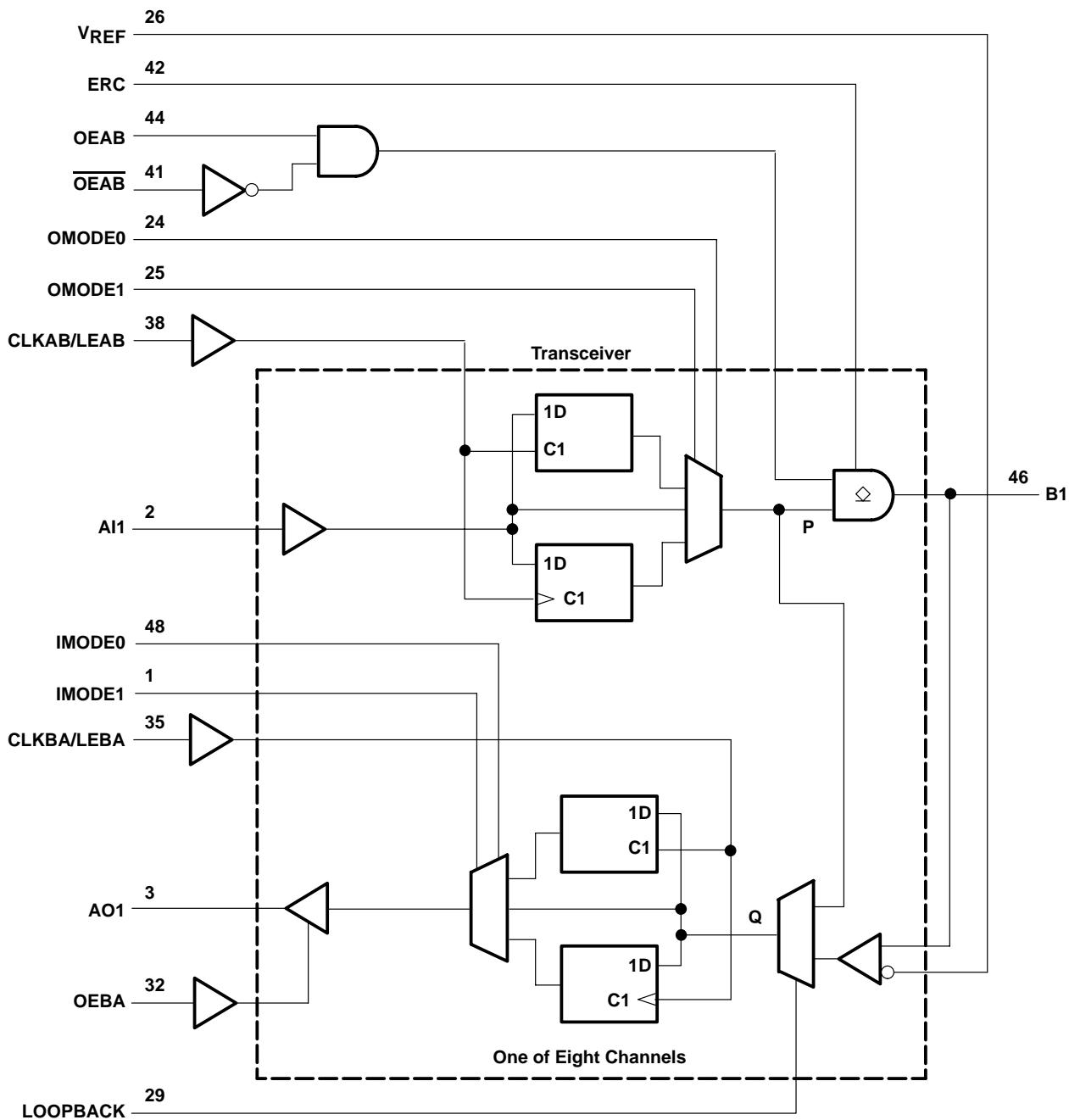

Pin numbers shown are for the DGG and DGV packages.

**SN74GTLP2034**

**8-BIT LVTTTL-TO-GTLP ADJUSTABLE-EDGE-RATE REGISTERED TRANSCEIVER  
WITH SPLIT LVTTTL PORT AND FEEDBACK PATH**

SCES353C – JUNE 2001 – REVISED SEPTEMBER 2001

**absolute maximum ratings over operating free-air temperature range (unless otherwise noted)†**

Supply voltage range, $V_{CC}$ and BIAS $V_{CC}$ .....	-0.5 V to 4.6 V
Input voltage range, $V_I$ (see Note 1): AI port, ERC, and control inputs .....	-0.5 V to 7 V
B port and $V_{REF}$ .....	-0.5 V to 4.6 V
Voltage range applied to any output in the high-impedance or power-off state, $V_O$ (see Note 1): AO port .....	-0.5 V to 7 V
B port .....	-0.5 V to 4.6 V
Current into any output in the low state, $I_O$ : AO port .....	48 mA
B port .....	200 mA
Current into any A-port output in the high state, $I_O$ (see Note 2) .....	48 mA
Continuous current through each $V_{CC}$ or GND .....	$\pm 100$ mA
Input clamp current, $I_{IK}$ ( $V_I < 0$ ) .....	-50 mA
Output clamp current, $I_{OK}$ ( $V_O < 0$ ) .....	-50 mA
Package thermal impedance, $\theta_{JA}$ (see Note 3): DGG package .....	70°C/W
DGV package .....	58°C/W
GQL package .....	42°C/W
Storage temperature range, $T_{stg}$ .....	-65°C to 150°C

† Stresses beyond those listed under “absolute maximum ratings” may cause permanent damage to the device. These are stress ratings only, and functional operation of the device at these or any other conditions beyond those indicated under “recommended operating conditions” is not implied. Exposure to absolute-maximum-rated conditions for extended periods may affect device reliability.

- NOTES: 1. The input and output negative-voltage ratings may be exceeded if the input and output clamp-current ratings are observed.  
 2. This current flows only when the output is in the high state and  $V_O > V_{CC}$ .  
 3. The package thermal impedance is calculated in accordance with JESD 51-7.



# 8-BIT LVTTTL-TO-GTLP ADJUSTABLE-EDGE-RATE REGISTERED TRANSCEIVER WITH SPLIT LVTTTL PORT AND FEEDBACK PATH

SCES353C – JUNE 2001 – REVISED SEPTEMBER 2001

## recommended operating conditions (see Notes 4 through 7)

		MIN	NOM	MAX	UNIT	
$V_{CC}$ , BIAS $V_{CC}$	Supply voltage	3.15	3.3	3.45	V	
$V_{TT}$	Termination voltage	GTLP	1.14	1.2	1.26	V
		GTL	1.35	1.5	1.65	
$V_{REF}$	Reference voltage	GTLP	0.74	0.8	0.87	V
		GTL	0.87	1	1.1	
$V_I$	Input voltage	B port	$V_{TT}$		V	
		Except B port and $V_{REF}$	$V_{CC}$	5.5		
$V_{IH}$	High-level input voltage	B port	$V_{REF}+0.05$		V	
		Except B port	2			
$V_{IL}$	Low-level input voltage	B port	$V_{REF}-0.05$		V	
		Except B port	0.8			
$I_{IK}$	Input clamp current			-18	mA	
$I_{OH}$	High-level output current	AO			-24	mA
$I_{OL}$	Low-level output current	AO			24	mA
		B port			100	
$\Delta t/\Delta v$	Input transition rise or fall rate	Outputs enabled		10	ns/V	
$\Delta t/\Delta V_{CC}$	Power-up ramp rate	20			$\mu\text{s}/\text{V}$	
$T_A$	Operating free-air temperature	-40		85	$^{\circ}\text{C}$	

- NOTES: 4. All unused control and B-port inputs of the device must be held at  $V_{CC}$  or GND to ensure proper device operation. Refer to the TI application report, *Implications of Slow or Floating CMOS Inputs*, literature number SCBA004.
5. Proper connection sequence for use of the B-port I/O precharge feature is GND and BIAS  $V_{CC}=3.3\text{ V}$  first, I/O second, and  $V_{CC}=3.3\text{ V}$  last, because the BIAS  $V_{CC}$  precharge circuitry is disabled when any  $V_{CC}$  pin is connected. The control and  $V_{REF}$  inputs can be connected anytime, but normally are connected during the I/O stage. If B-port precharge is not required, any connection sequence is acceptable but, generally, GND is connected first.
6.  $V_{TT}$  and  $R_{TT}$  can be adjusted to accommodate backplane impedances if the dc recommended  $I_{OL}$  ratings are not exceeded.
7.  $V_{REF}$  can be adjusted to optimize noise margins, but normally is two-thirds  $V_{TT}$ . TI-OPC circuitry is enabled in the A-to-B direction and is activated when  $V_{TT} > 0.7\text{ V}$  above  $V_{REF}$ . If operated in the A-to-B direction,  $V_{REF}$  should be set to within 0.6 V of  $V_{TT}$  to minimize current drain.



**SN74GTL2034**  
**8-BIT LVTTTL-TO-GTLP ADJUSTABLE-EDGE-RATE REGISTERED TRANSCEIVER**  
**WITH SPLIT LVTTTL PORT AND FEEDBACK PATH**

SCES353C – JUNE 2001 – REVISED SEPTEMBER 2001

**electrical characteristics over recommended operating free-air temperature range for GTLP (unless otherwise noted)**

PARAMETER		TEST CONDITIONS		MIN	TYP†	MAX	UNIT
$V_{IK}$		$V_{CC} = 3.15\text{ V}$ , $I_I = -18\text{ mA}$				-1.2	V
$V_{OH}$	AO	$V_{CC} = 3.15\text{ V to } 3.45\text{ V}$ , $I_{OH} = -100\text{ }\mu\text{A}$		$V_{CC}-0.2$			V
		$V_{CC} = 3.15\text{ V}$		2.4			
$V_{OL}$	AO	$V_{CC} = 3.15\text{ V to } 3.45\text{ V}$ , $I_{OL} = 100\text{ }\mu\text{A}$				0.2	V
		$V_{CC} = 3.15\text{ V}$		$I_{OL} = 12\text{ mA}$		0.4	
				$I_{OL} = 24\text{ mA}$		0.5	
	B port	$V_{CC} = 3.15\text{ V}$		$I_{OL} = 10\text{ mA}$		0.2	
				$I_{OL} = 64\text{ mA}$		0.4	
				$I_{OL} = 100\text{ mA}$		0.55	
$I_I^\ddagger$	AI and control inputs	$V_{CC} = 3.45\text{ V}$ , $V_I = 0\text{ or } 5.5\text{ V}$				$\pm 10$	$\mu\text{A}$
$I_{OZ}^\ddagger$	AO	$V_{CC} = 3.45\text{ V}$ , $V_O = 0\text{ to } 5.5\text{ V}$				$\pm 10$	$\mu\text{A}$
	B port	$V_{CC} = 3.45\text{ V}$ , $V_{REF}$ within 0.6 V of $V_{TT}$ , $V_O = 0\text{ to } 2.3\text{ V}$				$\pm 10$	
$I_{CC}$	AO or B port	$V_{CC} = 3.45\text{ V}$ , $I_O = 0$ , $V_I$ (A-port or control input) = $V_{CC}$ or GND, $V_I$ (B port) = $V_{TT}$ or GND		Outputs high		40	mA
				Outputs low		40	
				Outputs disabled		40	
$\Delta I_{CC}^\S$		$V_{CC} = 3.45\text{ V}$ , One AI or control input at $V_{CC} - 0.6\text{ V}$ , Other AI or control inputs at $V_{CC}$ or GND				1.5	mA
$C_i$	AI	$V_I = 3.15\text{ V or } 0$			3.5	4.5	pF
	Control inputs				3.5	5.5	
$C_o$	AO	$V_O = 3.15\text{ V or } 0$			5	6	pF
$C_{io}$	B port	$V_O = 1.5\text{ V or } 0$			8.5	10	pF

† All typical values are at  $V_{CC} = 3.3\text{ V}$ ,  $T_A = 25^\circ\text{C}$ .

‡ For I/O ports, the parameter  $I_{OZ}$  includes the input leakage current.

§ This is the increase in supply current for each input that is at the specified TTL voltage level rather than  $V_{CC}$  or GND.

**hot-insertion specifications for A port over recommended operating free-air temperature range**

PARAMETER	TEST CONDITIONS			MIN	MAX	UNIT
$I_{off}$	$V_{CC} = 0$ ,	$V_I$ or $V_O = 0\text{ to } 5.5\text{ V}$			10	$\mu\text{A}$
$I_{OZPU}$	$V_{CC} = 0\text{ to } 1.5\text{ V}$ ,	$V_O = 0.5\text{ V to } 3\text{ V}$ ,	$OEBA = V_{CC}$		$\pm 30$	$\mu\text{A}$
$I_{OZPD}$	$V_{CC} = 1.5\text{ V to } 0$ ,	$V_O = 0.5\text{ V to } 3\text{ V}$ ,	$OEBA = V_{CC}$		$\pm 30$	$\mu\text{A}$

**live-insertion specifications for B port over recommended operating free-air temperature range**

PARAMETER	TEST CONDITIONS			MIN	MAX	UNIT
$I_{off}$	$V_{CC} = 0$ ,	BIAS $V_{CC} = 0$ ,	$V_I$ or $V_O = 0\text{ to } 1.5\text{ V}$		10	$\mu\text{A}$
$I_{OZPU}$	$V_{CC} = 0\text{ to } 1.5\text{ V}$ ,	BIAS $V_{CC} = 0$ ,	$V_O = 0.5\text{ V to } 1.5\text{ V}$ , $\overline{OEAB} = 0$ and $OEAB = V_{CC}$		$\pm 30$	$\mu\text{A}$
$I_{OZPD}$	$V_{CC} = 1.5\text{ V to } 0$ ,	BIAS $V_{CC} = 0$ ,	$V_O = 0.5\text{ V to } 1.5\text{ V}$ , $\overline{OEAB} = 0$ and $OEAB = V_{CC}$	$\pm 30$	$\pm 30$	$\mu\text{A}$
$I_{CC}$ (BIAS $V_{CC}$ )	$V_{CC} = 0\text{ to } 3.15\text{ V}$	BIAS $V_{CC} = 3.15\text{ V to } 3.45\text{ V}$ , $V_O$ (B port) = $0\text{ to } 1.5\text{ V}$			5	mA
	$V_{CC} = 3.15\text{ V to } 3.45\text{ V}$				10	
$V_O$	$V_{CC} = 0$ ,	BIAS $V_{CC} = 3.3\text{ V}$ ,	$I_O = 0$	0.95	1.05	V
$I_O$	$V_{CC} = 0$ ,	BIAS $V_{CC} = 3.15\text{ V to } 3.45\text{ V}$ ,	$V_O$ (B port) = $0.6\text{ V}$	-1		$\mu\text{A}$



**SN74GTLP2034**

**8-BIT LVTTTL-TO-GTLP ADJUSTABLE-EDGE-RATE REGISTERED TRANSCEIVER  
WITH SPLIT LVTTTL PORT AND FEEDBACK PATH**

SCES353C – JUNE 2001 – REVISED SEPTEMBER 2001

timing requirements over recommended ranges of supply voltage and operating free-air temperature,  $V_{TT} = 1.5\text{ V}$  and  $V_{REF} = 1\text{ V}$  for GTLP (unless otherwise noted)

		MIN	MAX	UNIT
$f_{\text{clock}}$	Clock frequency		175	MHz
$t_w$	Pulse duration	CLKAB/LEAB or CLKBA/LEBA		ns
$t_{\text{su}}$	Setup time	A1 before CLKAB $\uparrow$		1.1
		A1 before CLKBA $\uparrow$		1.4
		B before CLKBA $\uparrow$		1.3
		A1 before LEAB $\downarrow$		1.3
		A1 before LEBA $\downarrow$		2.1
		B before LEBA $\downarrow$		2.2
$t_h$	Hold time	A1 after CLKAB $\uparrow$		0.3
		A1 after CLKBA $\uparrow$		0.2
		B after CLKBA $\uparrow$		0.2
		A1 after LEAB $\downarrow$		0.3
		A1 after LEBA $\downarrow$		0
		B after LEBA $\downarrow$		0



**SN74GTL2034**

**8-BIT LVTTTL-TO-GTLP ADJUSTABLE-EDGE-RATE REGISTERED TRANSCEIVER  
WITH SPLIT LVTTTL PORT AND FEEDBACK PATH**

SCES353C – JUNE 2001 – REVISED SEPTEMBER 2001

switching characteristics over recommended ranges of supply voltage and operating free-air temperature,  $V_{TT} = 1.5\text{ V}$  and  $V_{REF} = 1\text{ V}$  for GTLP (see Figure 1)

PARAMETER	FROM (INPUT)	TO (OUTPUT)	EDGE RATE†	MIN	TYP‡	MAX	UNIT
$f_{max}$				175			MHz
$t_{PLH}$	AI (buffer)	B	Slow	3	7.1	7	ns
$t_{PHL}$				3			
$t_{PLH}$	AI (buffer)	B	Fast	2	5.6	5.7	ns
$t_{PHL}$				2			
$t_{PLH}$	B (buffer)	AO	–	1	5.4	4.8	ns
$t_{PHL}$				1			
$t_{PLH}$	LEAB (latch mode)	B	Slow	4.2	8.5	7.3	ns
$t_{PHL}$				3.2			
$t_{PLH}$	LEAB (latch mode)	B	Fast	3.2	7.1	6.3	ns
$t_{PHL}$				2.8			
$t_{PLH}$	LEAB (latch mode)	AO	–	2	6.6	5.8	ns
$t_{PHL}$				1.8			
$t_{PLH}$	LEBA (latch mode)	AO	–	1	5.3	4.5	ns
$t_{PHL}$				1			
$t_{PLH}$	OEAB	B	Slow	3.8	7.5	7	ns
$t_{PHL}$				3.1			
$t_{PLH}$	OEAB	B	Fast	2.5	6	6	ns
$t_{PHL}$				2.5			
$t_{PLH}$	$\overline{OEAB}$	B	Slow	3.5	7.5	7.2	ns
$t_{PHL}$				3			
$t_{PLH}$	$\overline{OEAB}$	B	Fast	2.5	6	6	ns
$t_{PHL}$				2.5			
$t_{PZH}$	OEBA	AO	–	1	4.7	3.4	ns
$t_{PZL}$				1			
$t_{PHZ}$	OEBA	AO	–	1	5.2	4.9	ns
$t_{PLZ}$				1			
$t_{PLH}$	CLKAB (flip-flop mode)	B	Slow	4.4	8.6	8	ns
$t_{PHL}$				3.6			
$t_{PLH}$	CLKAB (flip-flop mode)	B	Fast	3.2	7.1	6.8	ns
$t_{PHL}$				3.1			
$t_{PLH}$	CLKAB (flip-flop mode)	AO	–	2	6.9	6.4	ns
$t_{PHL}$				1.8			
$t_{PLH}$	CLKBA (flip-flop mode)	AO	–	1	5.6	4.9	ns
$t_{PHL}$				1			
$t_{PLH}$	OMODE	B	Slow	3.8	8.7	8.2	ns
$t_{PHL}$				3.2			
$t_{PLH}$	OMODE	B	Fast	2.7	7	7	ns
$t_{PHL}$				2.7			
$t_{PLH}$	IMODE	AO	–	1	5.6	4.6	ns
$t_{PHL}$				1			

† Slow (ERC = H) and Fast (ERC = L)

‡ All typical values are at  $V_{CC} = 3.3\text{ V}$ ,  $T_A = 25^\circ\text{C}$ .



**8-BIT LVTTTL-TO-GTLP ADJUSTABLE-EDGE-RATE REGISTERED TRANSCEIVER WITH SPLIT LVTTTL PORT AND FEEDBACK PATH**

SCES353C – JUNE 2001 – REVISED SEPTEMBER 2001

switching characteristics over recommended ranges of supply voltage and operating free-air temperature,  $V_{TT} = 1.5\text{ V}$  and  $V_{REF} = 1\text{ V}$  for GTLP (see Figure 1) (continued)

PARAMETER	FROM (INPUT)	TO (OUTPUT)	EDGE RATE†	MIN	TYP‡	MAX	UNIT
$t_{PLH}$	LOOPBACK	AO	–	2.5		5.5	ns
$t_{PHL}$				2	4.7		
$t_{PLH}$	AI (loopback high)	AO	–	1		5.3	ns
$t_{PHL}$				1	4.9		
$t_r$	Rise time, B-port outputs (20% to 80%)		Slow	2.8		ns	
			Fast	1.5			
	Rise time, AO (10% to 90%)			3.5			
$t_f$	Fall time, B-port outputs (80% to 20%)		Slow	3		ns	
			Fast	1.8			
	Fall time, AO (90% to 10%)			1.5			

† Slow (ERC = H) and Fast (ERC = L)

‡ All typical values are at  $V_{CC} = 3.3\text{ V}$ ,  $T_A = 25^\circ\text{C}$ .

skew characteristics over recommended ranges of supply voltage and operating free-air temperature (see Figure 1)§

PARAMETER	FROM (INPUT)	TO (OUTPUT)	EDGE RATE†	MIN	TYP‡	MAX	UNIT
$t_{sk(LH)}^{\parallel}$	AI	B	Slow	0.5		1	ns
$t_{sk(HL)}^{\parallel}$				0.5	1		
$t_{sk(LH)}^{\parallel}$	AI	B	Fast	0.4		0.9	ns
$t_{sk(HL)}^{\parallel}$				0.4	0.9		
$t_{sk(LH)}^{\parallel}$	CLKAB/LEAB	B	Slow	0.5		1	ns
$t_{sk(HL)}^{\parallel}$				0.5	1		
$t_{sk(LH)}^{\parallel}$	CLKAB/LEAB	B	Fast	0.4		0.9	ns
$t_{sk(HL)}^{\parallel}$				0.4	0.9		
$t_{sk(t)}^{\parallel}$	AI	B	Slow	1.4		2	ns
			Fast	0.6	1.4		
	CLKAB/LEAB	B	Slow	1.8	2.5		
			Fast	0.9	1.8		

† Slow (ERC = L) and Fast (ERC = H)

‡ All typical values are at  $V_{CC} = 3.3\text{ V}$ ,  $T_A = 25^\circ\text{C}$ .

§ Actual skew values between the GTLP outputs could vary on the backplane due to the loading and impedance seen by the device.

¶  $t_{sk(LH)}/t_{sk(HL)}$  and  $t_{sk(t)}$  – Output-to-output skew is defined as the absolute value of the difference between the actual propagation delay for all outputs with the same packaged device. The specifications are given for specific worst-case  $V_{CC}$  and temperature and apply to any outputs switching in the same direction either high to low [ $t_{sk(HL)}$ ] or low to high [ $t_{sk(LH)}$ ] or in opposite directions, both low to high and high to low [ $t_{sk(t)}$ ].



**SN74GTL2034**  
**8-BIT LVTTTL-TO-GTLP ADJUSTABLE-EDGE-RATE REGISTERED TRANSCEIVER**  
**WITH SPLIT LVTTTL PORT AND FEEDBACK PATH**

SCES353C – JUNE 2001 – REVISED SEPTEMBER 2001

**PARAMETER MEASUREMENT INFORMATION**

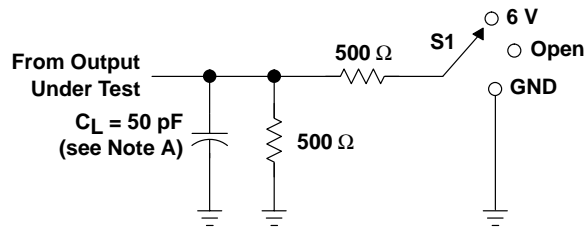

**LOAD CIRCUIT FOR A OUTPUTS**

TEST	S1
tPLH/tPHL	Open
tPLZ/tPZL	6 V
tPHZ/tPZH	GND

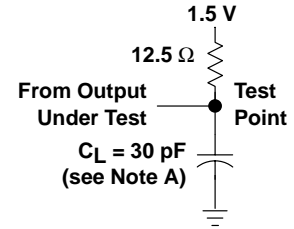

**LOAD CIRCUIT FOR B OUTPUTS**

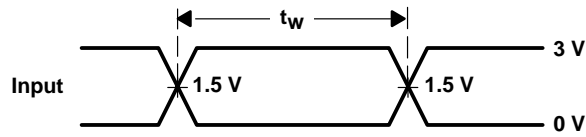

**VOLTAGE WAVEFORMS  
PULSE DURATION**

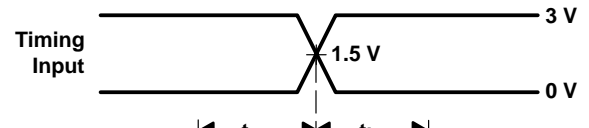

**VOLTAGE WAVEFORMS  
SETUP AND HOLD TIMES**

(VM = 1.5 V for A port and 1 V for B port)  
 (VOH = 3 V for A port and 1.5 V for B port)



**VOLTAGE WAVEFORMS  
PROPAGATION DELAY TIMES  
(A to B port)**

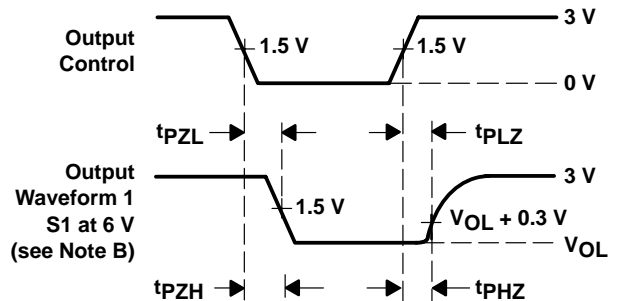

**VOLTAGE WAVEFORMS  
ENABLE AND DISABLE TIMES  
(AO)**

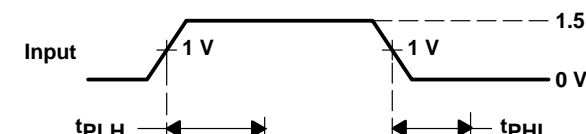

**VOLTAGE WAVEFORMS  
PROPAGATION DELAY TIMES  
(B port to AO)**

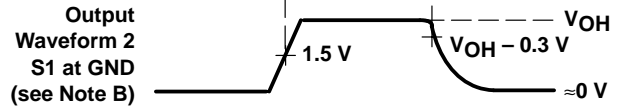

- NOTES: A. CL includes probe and jig capacitance.  
 B. Waveform 1 is for an output with internal conditions such that the output is low except when disabled by the output control. Waveform 2 is for an output with internal conditions such that the output is high except when disabled by the output control.  
 C. All input pulses are supplied by generators having the following characteristics: PRR = 10 MHz, ZO = 50 Ω, tr ≈ 2 ns, tf ≈ 2 ns.  
 D. The outputs are measured one at a time with one transition per measurement.

**Figure 1. Load Circuits and Voltage Waveforms**

DISTRIBUTED-LOAD BACKPLANE SWITCHING CHARACTERISTICS

The preceding switching characteristics table shows the switching characteristics of the device into a lumped load (Figure 1). However, the designer's backplane application is probably a distributed load. The physical representation is shown in Figure 2. This backplane, or distributed load, can be closely approximated to a resistor inductance capacitance (RLC) circuit, as shown in Figure 3. This device has been designed for optimum performance in this RLC circuit. The following switching characteristics table shows the switching characteristics of the device into the RLC load, to help the designer to better understand the performance of the GTLP device in this typical backplane. See [www.ti.com/sc/gtlp](http://www.ti.com/sc/gtlp) for more information.

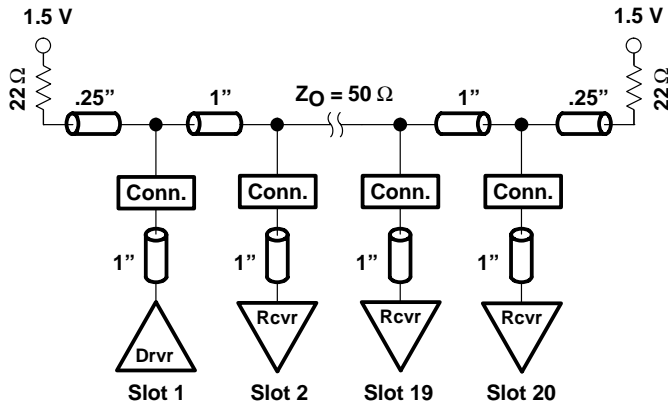

Figure 2. High-Drive Test Backplane

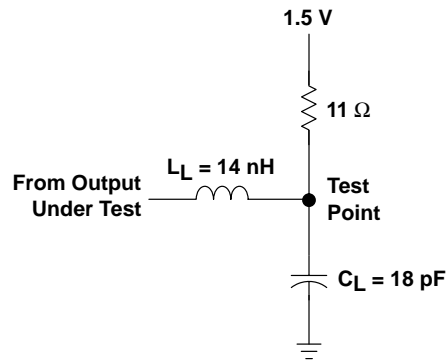

Figure 3. High-Drive RLC Network

**SN74GTL2034**

**8-BIT LVTTTL-TO-GTLP ADJUSTABLE-EDGE-RATE REGISTERED TRANSCEIVER  
WITH SPLIT LVTTTL PORT AND FEEDBACK PATH**

SCES353C – JUNE 2001 – REVISED SEPTEMBER 2001

**switching characteristics over recommended operating conditions for the bus transceiver function (unless otherwise noted) (see Figure 3)**

PARAMETER	FROM (INPUT)	TO (OUTPUT)	EDGE RATE†	TYP‡	UNIT
t <sub>PLH</sub>	AI (buffer)	B	Slow	5.7	ns
t <sub>PHL</sub>				5.2	
t <sub>PLH</sub>	AI (buffer)	B	Fast	3.7	ns
t <sub>PHL</sub>				4.1	
t <sub>PLH</sub>	LEAB (latch mode)	B	Slow	5.9	ns
t <sub>PHL</sub>				5.7	
t <sub>PLH</sub>	LEAB (latch mode)	B	Fast	4.8	ns
t <sub>PHL</sub>				4.8	
t <sub>PLH</sub>	CLKAB (flip-flop mode)	B	Slow	5.7	ns
t <sub>PHL</sub>				6.4	
t <sub>PLH</sub>	CLKAB (flip-flop mode)	B	Fast	4.7	ns
t <sub>PHL</sub>				5.2	
t <sub>PLH</sub>	OMODE	B	Slow	5.4	ns
t <sub>PHL</sub>				6	
t <sub>PLH</sub>	OMODE	B	Fast	4.5	ns
t <sub>PHL</sub>				4.9	
t <sub>r</sub>	Rise time, B-port outputs (20% to 80%)		Slow	2	ns
			Fast	1.1	
t <sub>f</sub>	Fall time, B-port outputs (80% to 20%)		Slow	3.3	ns
			Fast	2.3	

† Slow (ERC = H) and Fast (ERC = L)

‡ All typical values are at V<sub>CC</sub> = 3.3 V, T<sub>A</sub> = 25°C. All values are derived from TI-SPICE models.

DGV (R-PDSO-G\*\*)

PLASTIC SMALL-OUTLINE

24 PINS SHOWN

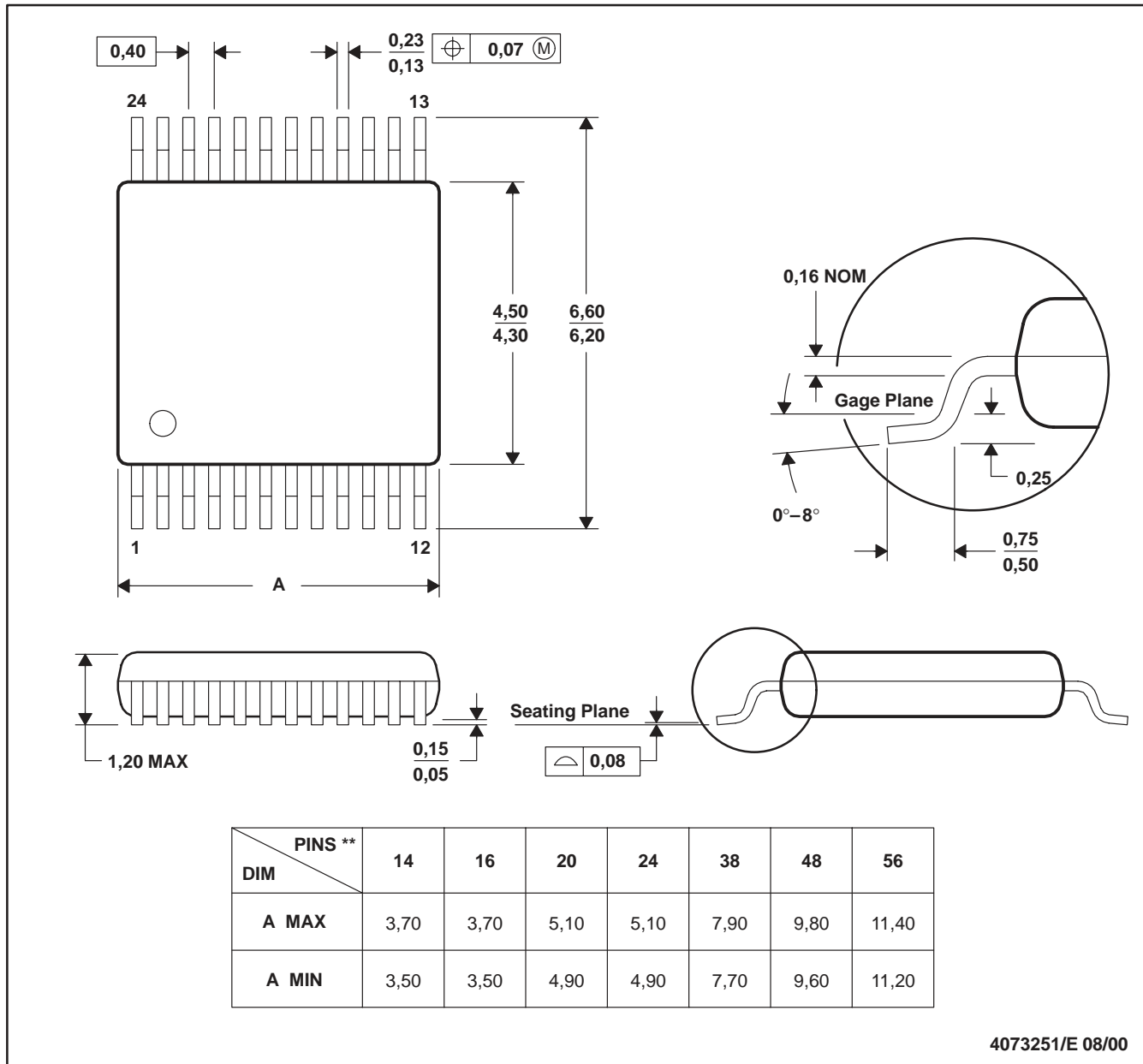

- NOTES: A. All linear dimensions are in millimeters.  
 B. This drawing is subject to change without notice.  
 C. Body dimensions do not include mold flash or protrusion, not to exceed 0,15 per side.  
 D. Falls within JEDEC: 24/48 Pins – MO-153  
 14/16/20/56 Pins – MO-194



GQL (R-PBGA-N56)

PLASTIC BALL GRID ARRAY

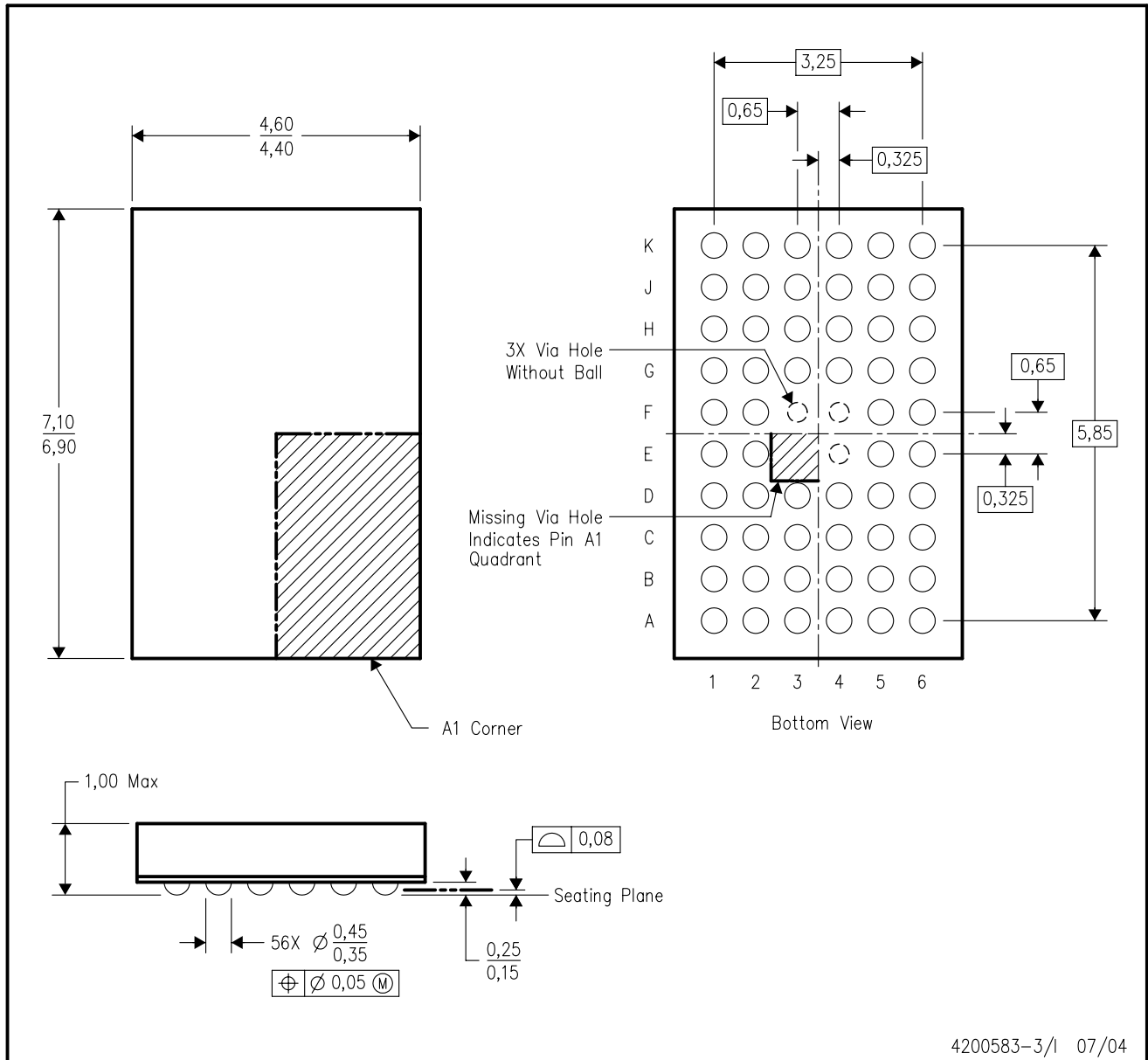

- NOTES:
- A. All linear dimensions are in millimeters.
  - B. This drawing is subject to change without notice.
  - C. Falls within JEDEC MO-225 variation BA.
  - D. This package is tin-lead (SnPb). Refer to the 56 ZQL package (drawing 4204437) for lead-free.

DGG (R-PDSO-G\*\*)

PLASTIC SMALL-OUTLINE PACKAGE

48 PINS SHOWN

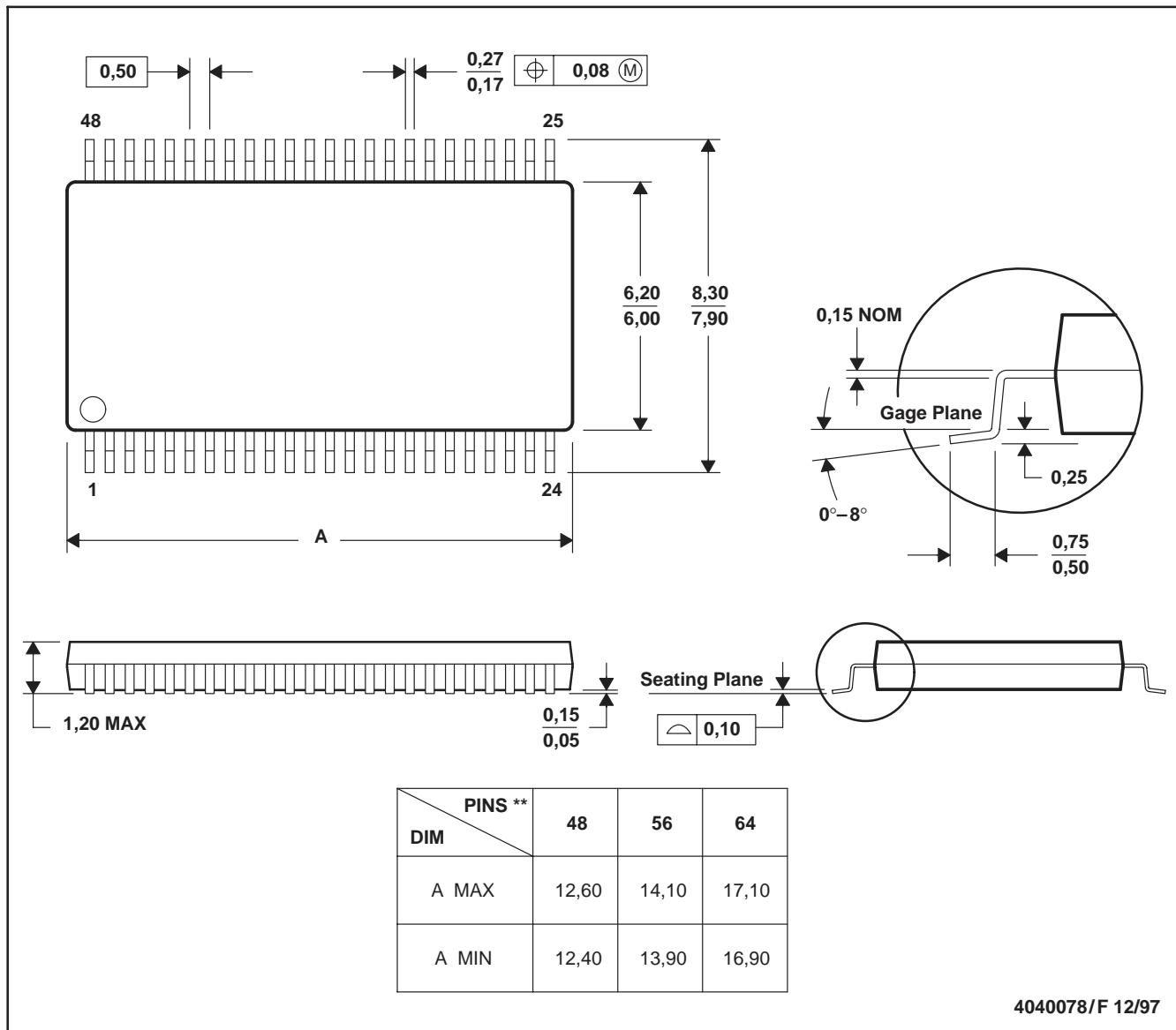

- NOTES: A. All linear dimensions are in millimeters.  
 B. This drawing is subject to change without notice.  
 C. Body dimensions do not include mold protrusion not to exceed 0,15.  
 D. Falls within JEDEC MO-153

## IMPORTANT NOTICE

Texas Instruments Incorporated and its subsidiaries (TI) reserve the right to make corrections, modifications, enhancements, improvements, and other changes to its products and services at any time and to discontinue any product or service without notice. Customers should obtain the latest relevant information before placing orders and should verify that such information is current and complete. All products are sold subject to TI's terms and conditions of sale supplied at the time of order acknowledgment.

TI warrants performance of its hardware products to the specifications applicable at the time of sale in accordance with TI's standard warranty. Testing and other quality control techniques are used to the extent TI deems necessary to support this warranty. Except where mandated by government requirements, testing of all parameters of each product is not necessarily performed.

TI assumes no liability for applications assistance or customer product design. Customers are responsible for their products and applications using TI components. To minimize the risks associated with customer products and applications, customers should provide adequate design and operating safeguards.

TI does not warrant or represent that any license, either express or implied, is granted under any TI patent right, copyright, mask work right, or other TI intellectual property right relating to any combination, machine, or process in which TI products or services are used. Information published by TI regarding third-party products or services does not constitute a license from TI to use such products or services or a warranty or endorsement thereof. Use of such information may require a license from a third party under the patents or other intellectual property of the third party, or a license from TI under the patents or other intellectual property of TI.

Reproduction of information in TI data books or data sheets is permissible only if reproduction is without alteration and is accompanied by all associated warranties, conditions, limitations, and notices. Reproduction of this information with alteration is an unfair and deceptive business practice. TI is not responsible or liable for such altered documentation.

Resale of TI products or services with statements different from or beyond the parameters stated by TI for that product or service voids all express and any implied warranties for the associated TI product or service and is an unfair and deceptive business practice. TI is not responsible or liable for any such statements.

Following are URLs where you can obtain information on other Texas Instruments products and application solutions:

<b>Products</b>		<b>Applications</b>	
Amplifiers	<a href="http://amplifier.ti.com">amplifier.ti.com</a>	Audio	<a href="http://www.ti.com/audio">www.ti.com/audio</a>
Data Converters	<a href="http://dataconverter.ti.com">dataconverter.ti.com</a>	Automotive	<a href="http://www.ti.com/automotive">www.ti.com/automotive</a>
DSP	<a href="http://dsp.ti.com">dsp.ti.com</a>	Broadband	<a href="http://www.ti.com/broadband">www.ti.com/broadband</a>
Interface	<a href="http://interface.ti.com">interface.ti.com</a>	Digital Control	<a href="http://www.ti.com/digitalcontrol">www.ti.com/digitalcontrol</a>
Logic	<a href="http://logic.ti.com">logic.ti.com</a>	Military	<a href="http://www.ti.com/military">www.ti.com/military</a>
Power Mgmt	<a href="http://power.ti.com">power.ti.com</a>	Optical Networking	<a href="http://www.ti.com/opticalnetwork">www.ti.com/opticalnetwork</a>
Microcontrollers	<a href="http://microcontroller.ti.com">microcontroller.ti.com</a>	Security	<a href="http://www.ti.com/security">www.ti.com/security</a>
		Telephony	<a href="http://www.ti.com/telephony">www.ti.com/telephony</a>
		Video & Imaging	<a href="http://www.ti.com/video">www.ti.com/video</a>
		Wireless	<a href="http://www.ti.com/wireless">www.ti.com/wireless</a>

Mailing Address: Texas Instruments  
Post Office Box 655303 Dallas, Texas 75265