



Bridgelux® Gen 8 V15 Array Series

Product Data Sheet DS414



Introduction

V Series

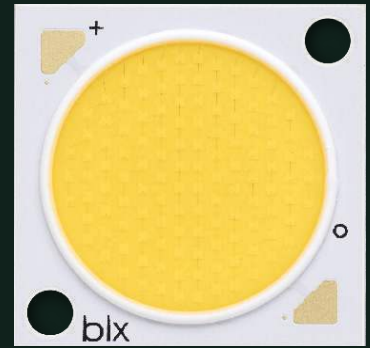

The V Series™ LED Array products deliver high quality light in a compact and cost-effective solid-state lighting package. These chip on board (CoB) arrays can be efficiently driven up to three times the nominal drive current, enabling design flexibility not previously possible. These high flux density light sources are designed to support a wide range of high quality, low cost directional luminaires and replacement lamps for both interior and exterior commercial and residential applications.

The V15 LED Array is available in a variety of electrical, CCT, and CRI combinations providing substantial design flexibility and energy efficiency advantages.

Lighting system designs incorporating these LED arrays deliver increased system level efficacy and a longer service life. Typical applications include replacement lamps and task, accent, spot, track, wide area, security, wall packs and down lights.

Features

- Efficacy of 178 lm/W typical, 3000K 80 CRI
- Reliable operation at up to 3x nominal current, 30% increase in maximum lumens per LES size
- Wide selection of CCT options (2700K-6500K) with minimum 70, 80 and 90 CRI options
- Uniform high-quality illumination
- 2 and 3 SDCM binning options (2700K – 4000K)
- Forward voltage bin codes and backside marking
- Instant light with unlimited dimming
- 5-Year warranty

Benefits

- Enables high efficiency lighting systems and lower operating costs
- Supports the trend toward luminaire miniaturization and delivers enhanced optical control
- Design flexibility for a broad range of lighting applications
- Clean white light without pixelation
- Uniform consistent white light
- Design flexibility for multi-source applications
- Easy to use with daylight and motion sensors to increase energy savings
- Design with confidence



Contents

Product Feature Map	2
Product Nomenclature	2
Product Selection Guide	3
Performance at Commonly Used Drive Currents	5
Electrical Characteristics	9
Eye Safety	10
Absolute Maximum Ratings	11
Performance Curves	12
Typical Radiation Pattern	13
Typical Color Spectrum	14
Mechanical Dimensions	15
Color Binning Information	16
Packaging and Labeling	17
Design Resources	19
Precautions	19
Disclaimers	19
About Bridgelux	20

Product Feature Map

Bridgelux arrays are fully engineered devices that provide consistent thermal and optical performance on an engineered mechanical platform. The V Series arrays are the most compact chip-on-board devices across all of Bridgelux's LED Array products.

The arrays incorporate several features to simplify design integration and assembly. Please visit www.bridgelux.com for more information on the V Series family of products.

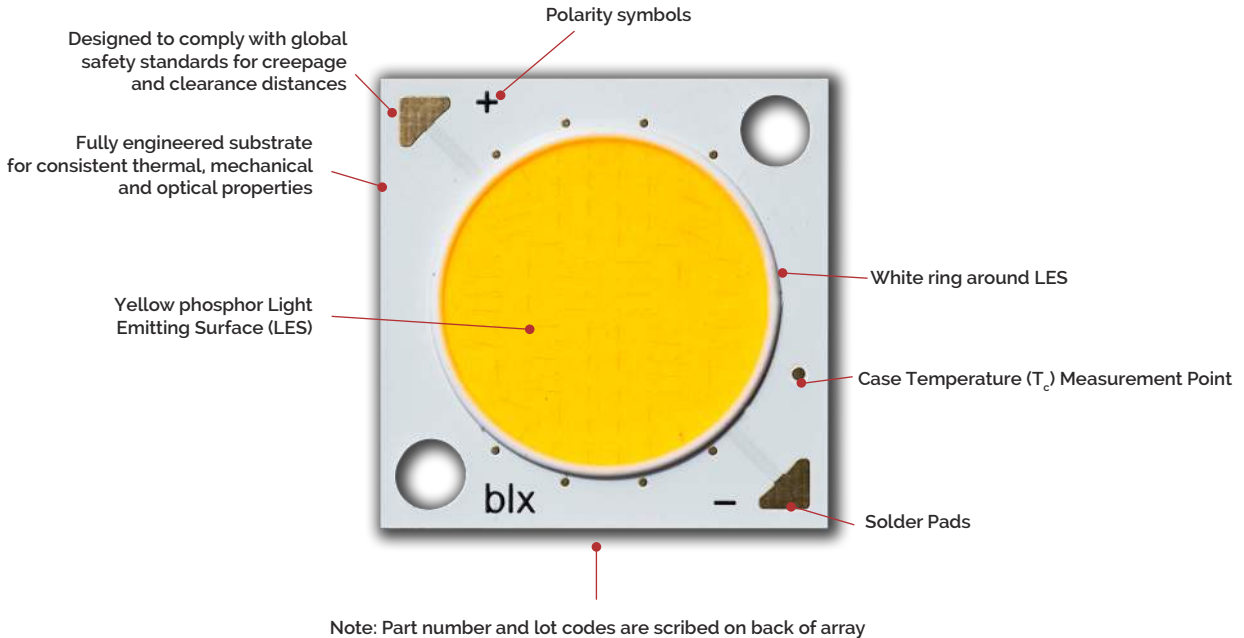

Product Nomenclature

The part number designation for Bridgelux V Series LED arrays is explained as follows:

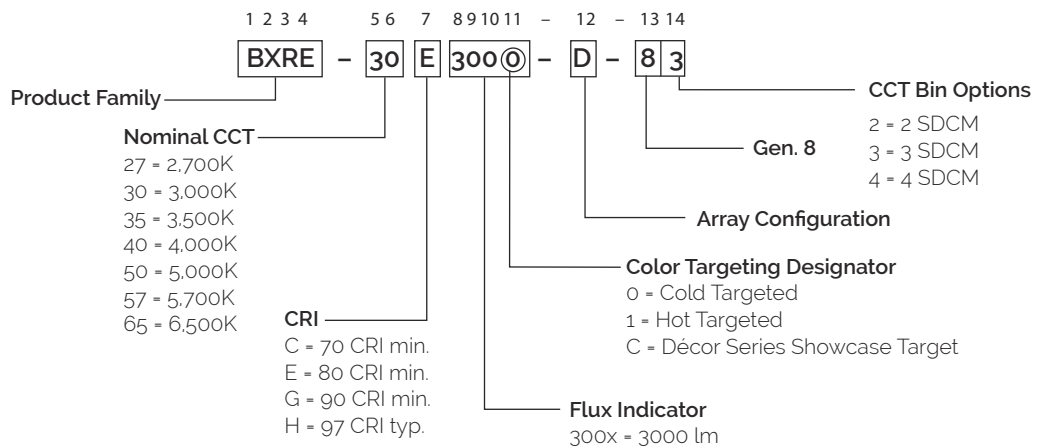

Product Selection Guide

The following product configurations are available:

Table 1: Selection Guide, Pulsed Measurement Data ($T_j = T_c = 25^\circ\text{C}$)

Part Number	Nominal CCT ¹ (K)	CRI ²	Nominal Drive Current ³ (mA)	Typical Pulsed Flux ^{4,5,6} $T_c = 25^\circ\text{C}$ (lm)	Minimum Pulsed Flux ^{6,7} $T_c = 25^\circ\text{C}$ (lm)	Typical V_f (V)	Typical Power (W)	Typical Efficacy (lm/W)
BXRE-27E3000-D-8x	2700	80	500	2827	2545	33.7	16.9	168
BXRE-27G3000-D-8x	2700	90	500	2333	2099	33.7	16.9	138
BXRE-27G30Ho-D-8x	2700	90	500	2433	2190	33.7	16.9	144
BXRE-27H3000-D-8x	2700	97	500	2067	1861	33.7	16.9	123
BXRE-30C3001-D-8x	3000	70	500	3145	2831	33.7	16.9	187
BXRE-30E3000-D-8x	3000	80	500	3004	2704	33.7	16.9	178
BXRE-30G3000-D-8x	3000	90	500	2439	2195	33.7	16.9	145
BXRE-30G30Ho-D-8x	3000	90	500	2553	2298	33.7	16.9	152
BXRE-30H3000-D-8x	3000	97	500	2209	1988	33.7	16.9	131
BXRE-35E3000-D-8x	3500	80	500	3075	2767	33.7	16.9	182
BXRE-35G3000-D-8x	3500	90	500	2527	2274	33.7	16.9	150
BXRE-40C3001-D-8x	4000	70	500	3234	2910	33.7	16.9	192
BXRE-40E3000-D-8x	4000	80	500	3092	2783	33.7	16.9	184
BXRE-40G3000-D-8x	4000	90	500	2580	2322	33.7	16.9	153
BXRE-50C3001-D-8x	5000	70	500	3251	2926	33.7	16.9	193
BXRE-50E3001-D-8x	5000	80	500	3128	2815	33.7	16.9	186
BXRE-50G3001-D-8x	5000	90	500	2704	2433	33.7	16.9	160
BXRE-57C3001-D-8x	5700	70	500	3163	2847	33.7	16.9	188
BXRE-57E3001-D-8x	5700	80	500	3004	2704	33.7	16.9	178
BXRE-65C3001-D-8x	6500	70	500	3163	2847	33.7	16.9	188
BXRE-65E3001-D-8x	6500	80	500	3039	2735	33.7	16.9	180

Notes for Table 1:

- Nominal CCT as defined by ANSI C78.377-2011. Products with a CCT of 5000K-6500K are hot targeted to $T_c = 85^\circ\text{C}$.
- CRI values are minimums for all products. Minimum Rg value for 80 CRI products is 0, the minimum Rg values for 90 CRI products is 50, the minimum Rg values for 97 CRI products is 93. Bridgelux maintains a ± 3 tolerance on Rg values.
- Drive current is referred to as nominal drive current.
- Products tested under pulsed condition (10ms pulse width) at nominal drive current where T_j (junction temperature) = T_c (case temperature) = 25°C .
- Typical performance values are provided as a reference only and are not a guarantee of performance.
- Bridgelux maintains a $\pm 7\%$ tolerance on flux measurements.
- Minimum flux values at the nominal test current are guaranteed by 100% test.

Product Selection Guide

Table 2: Selection Guide, Stabilized DC Performance ($T_c = 85^\circ\text{C}$)^{4,5}

Part Number	Nominal CCT ¹ (K)	CRI ²	Nominal Drive Current ³ (mA)	Typical DC Flux ^{4,5} $T_c = 85^\circ\text{C}$ (lm)	Minimum DC Flux ⁶ $T_c = 85^\circ\text{C}$ (lm)	Typical V_f (V)	Typical Power (W)	Typical Efficacy (lm/W)
BXRE-27E3000-D-8x	2700	80	500	2545	2290	33.0	16.5	154
BXRE-27G3000-D-8x	2700	90	500	2099	1889	33.0	16.5	127
BXRE-27G30H0-D-8x	2700	90	500	2190	1971	33.0	16.5	133
BXRE-27H3000-D-8x	2700	97	500	1861	1675	33.0	16.5	113
BXRE-30C3001-D-8x	3000	70	500	2831	2548	33.0	16.5	171
BXRE-30E3000-D-8x	3000	80	500	2704	2433	33.0	16.5	164
BXRE-30G3000-D-8x	3000	90	500	2195	1975	33.0	16.5	133
BXRE-30G30H0-D-8x	3000	90	500	2298	2068	33.0	16.5	139
BXRE-30H3000-D-8x	3000	97	500	1988	1789	33.0	16.5	120
BXRE-35E3000-D-8x	3500	80	500	2767	2490	33.0	16.5	168
BXRE-35G3000-D-8x	3500	90	500	2274	2047	33.0	16.5	138
BXRE-40C3001-D-8x	4000	70	500	2910	2619	33.0	16.5	176
BXRE-40E3000-D-8x	4000	80	500	2783	2505	33.0	16.5	169
BXRE-40G3000-D-8x	4000	90	500	2322	2090	33.0	16.5	141
BXRE-50C3001-D-8x	5000	70	500	2926	2634	33.0	16.5	177
BXRE-50E3001-D-8x	5000	80	500	2815	2533	33.0	16.5	170
BXRE-50G3001-D-8x	5000	90	500	2433	2190	33.0	16.5	147
BXRE-57C3001-D-8x	5700	70	500	2847	2562	33.0	16.5	172
BXRE-57E3001-D-8x	5700	80	500	2704	2433	33.0	16.5	164
BXRE-65C3001-D-8x	6500	70	500	2847	2562	33.0	16.5	172
BXRE-65E3001-D-8x	6500	80	500	2735	2462	33.0	16.5	166

Notes for Table 2:

- Nominal CCT as defined by ANSI C78.377-2011. Products with a CCT of 5000K-6500K are hot targeted to $T_c = 85^\circ\text{C}$.
- CRI values are minimums for all products. Minimum Rg value for 80 CRI products is 0, the minimum Rg values for 90 CRI products is 50, the minimum Rg values for 97 CRI products is 93. Bridgelux maintains a ± 3 tolerance on Rg values.
- Drive current is referred to as nominal drive current.
- Typical stabilized DC performance values are provided as reference only and are not a guarantee of performance.
- Typical performance is estimated based on operation under DC (direct current) with LED array mounted onto a heat sink with thermal interface material and the case temperature maintained at 85°C . Based on Bridgelux test setup, values may vary depending on the thermal design of the luminaire and/or the exposed environment to which the product is subjected.
- Minimum flux values at elevated temperatures are provided for reference only and are not guaranteed by 100% production testing. Based on Bridgelux test setup, values may vary depending on the thermal design of the luminaire and/or the exposed environment to which the product is subjected.

Performance at Commonly Used Drive Currents

V Series LED arrays are tested to the specifications shown using the nominal drive currents in Table 1. V Series may also be driven at other drive currents dependent on specific application design requirements. The performance at any drive current can be derived from the current vs. voltage characteristics shown in Figure 1 and the flux vs. current characteristics shown in Figure 2. The performance at commonly used drive currents is summarized in Table 3.

Table 3: Product Performance at Commonly Used Drive Currents

Part Number	CRI	Drive Current ¹ (mA)	Typical V _f T _c = 25°C (V)	Typical Power T _c = 25°C (W)	Typical Flux ² T _c = 25°C (lm)	Typical DC Flux ³ T _c = 85°C (lm)	Typical Efficacy T _c = 25°C (lm/W)
BXRE-27E3000-D-8x	80	250	32.6	8.2	1459	1313	179
		375	33.2	12.4	2154	1938	173
		500	33.7	16.9	2827	2545	168
		700	34.6	24.2	3888	3499	161
		1000	35.8	35.8	5396	4856	151
		1500	37.6	56.4	7710	6939	137
BXRE-27G3000-D-8x	90	250	32.6	8.2	1204	1083	148
		375	33.2	12.4	1777	1599	143
		500	33.7	16.9	2333	2099	138
		700	34.6	24.2	3207	2887	132
		1000	35.8	35.8	4451	4006	124
		1500	37.6	56.4	6361	5725	113
BXRE-27G30H0-D-8x	90	250	32.6	8.2	1256	1130	154
		375	33.2	12.4	1854	1668	149
		500	33.7	16.9	2433	2190	144
		700	34.6	24.2	3346	3011	138
		1000	35.8	35.8	4644	4179	130
		1500	37.6	56.4	6636	5972	118
BXRE-27H3000-D-8x	97	250	32.6	8.2	1067	960	131
		375	33.2	12.4	1575	1418	127
		500	33.7	16.9	2067	1861	123
		700	34.6	24.2	2843	2559	117
		1000	35.8	35.8	3945	3551	110
		1500	37.6	56.4	5638	5074	100
BXRE-30C3001-D-8x	70	250	32.6	8.2	1623	1461	199
		375	33.2	12.4	2396	2157	193
		500	33.7	16.9	3145	2831	186
		700	34.6	24.2	4325	3893	179
		1000	35.8	35.8	6003	5402	168
		1500	37.6	56.4	8578	7720	152
BXRE-30E3000-D-8x	80	250	32.6	8.2	1550	1395	190
		375	33.2	12.4	2288	2060	184
		500	33.7	16.9	3004	2704	178
		700	34.6	24.2	4131	3718	171
		1000	35.8	35.8	5733	5159	160
		1500	37.6	56.4	8192	7373	145

Notes for Table 3:

1. Alternate drive currents in Table 3 are provided for reference only and are not a guarantee of performance.
2. Bridgelux maintains a ± 7% tolerance on flux measurements.
3. Typical stabilized DC performance values are provided as reference only and are not a guarantee of performance.

Performance at Commonly Used Drive Currents

Table 3: Product Performance at Commonly Used Drive Currents (Continued)

Part Number	CRI	Drive Current ¹ (mA)	Typical V_f $T_c = 25^\circ\text{C}$ (V)	Typical Power $T_c = 25^\circ\text{C}$ (W)	Typical Flux ² $T_c = 25^\circ\text{C}$ (lm)	Typical DC Flux ³ $T_c = 85^\circ\text{C}$ (lm)	Typical Efficacy $T_c = 25^\circ\text{C}$ (lm/W)
BXRE-30G3000-D-8x	90	250	32.6	8.2	1259	1133	154
		375	33.2	12.4	1858	1672	149
		500	33.7	16.9	2439	2195	145
		700	34.6	24.2	3353	3018	138
		1000	35.8	35.8	4654	4188	130
		1500	37.6	56.4	6650	5985	118
BXRE-30G30Ho-D-8x	90	250	32.6	8.2	1318	1186	162
		375	33.2	12.4	1945	1751	156
		500	33.7	16.9	2553	2298	151
		700	34.6	24.2	3511	3160	145
		1000	35.8	35.8	4873	4386	136
		1500	37.6	56.4	6963	6267	123
BXRE-30H3000-D-8x	97	250	32.6	8.2	1140	1026	140
		375	33.2	12.4	1683	1514	135
		500	33.7	16.9	2209	1988	131
		700	34.6	24.2	3037	2734	125
		1000	35.8	35.8	4215	3794	118
		1500	37.6	56.4	6024	5421	107
BXRE-35E3000-D-8x	80	250	32.6	8.2	1587	1428	195
		375	33.2	12.4	2342	2108	188
		500	33.7	16.9	3075	2767	182
		700	34.6	24.2	4228	3805	175
		1000	35.8	35.8	5868	5281	164
		1500	37.6	56.4	8385	7547	149
BXRE-35G3000-D-8x	90	250	32.6	8.2	1304	1174	160
		375	33.2	12.4	1925	1733	155
		500	33.7	16.9	2527	2274	150
		700	34.6	24.2	3475	3127	143
		1000	35.8	35.8	4822	4340	135
		1500	37.6	56.4	6891	6202	122
BXRE-40C3001-D-8x	70	250	32.6	8.2	1669	1502	205
		375	33.2	12.4	2463	2217	198
		500	33.7	16.9	3234	2910	192
		700	34.6	24.2	4447	4002	184
		1000	35.8	35.8	6171	5554	172
		1500	37.6	56.4	8819	7937	156
BXRE-40E3000-D-8x	80	250	32.6	8.2	1596	1436	196
		375	33.2	12.4	2356	2120	189
		500	33.7	16.9	3092	2783	183
		700	34.6	24.2	4252	3827	176
		1000	35.8	35.8	5901	5311	165
		1500	37.6	56.4	8433	7590	150

Notes for Table 3:

1. Alternate drive currents in Table 3 are provided for reference only and are not a guarantee of performance.
2. Bridgelux maintains a $\pm 7\%$ tolerance on flux measurements.
3. Typical stabilized DC performance values are provided as reference only and are not a guarantee of performance.

Performance at Commonly Used Drive Currents

Table 3: Product Performance at Commonly Used Drive Currents (Continued)

Part Number	CRI	Drive Current ¹ (mA)	Typical V _f T _c = 25°C (V)	Typical Power T _c = 25°C (W)	Typical Flux ² T _c = 25°C (lm)	Typical DC Flux ³ T _c = 85°C (lm)	Typical Efficacy T _c = 25°C (lm/W)
BXRE-40G3000-D-8x	90	250	32.6	8.2	1331	1198	163
		375	33.2	12.4	1965	1769	158
		500	33.7	16.9	2580	2322	153
		700	34.6	24.2	3548	3193	146
		1000	35.8	35.8	4923	4431	138
		1500	37.6	56.4	7036	6332	125
BXRE-50C3001-D-8x	70	250	32.6	8.2	1678	1510	206
		375	33.2	12.4	2477	2229	199
		500	33.7	16.9	3251	2926	193
		700	34.6	24.2	4471	4024	185
		1000	35.8	35.8	6205	5584	173
		1500	37.6	56.4	8867	7980	157
BXRE-50E3001-D-8x	80	250	32.6	8.2	1614	1453	198
		375	33.2	12.4	2383	2144	191
		500	33.7	16.9	3128	2815	185
		700	34.6	24.2	4301	3871	178
		1000	35.8	35.8	5969	5372	167
		1500	37.6	56.4	8530	7677	151
BXRE-50G3001-D-8x	90	250	32.6	8.2	1395	1256	171
		375	33.2	12.4	2060	1854	165
		500	33.7	16.9	2704	2433	160
		700	34.6	24.2	3718	3346	153
		1000	35.8	35.8	5159	4644	144
		1500	37.6	56.4	7373	6636	131
BXRE-57C3001-D-8x	70	250	32.6	8.2	1632	1469	200
		375	33.2	12.4	2410	2169	194
		500	33.7	16.9	3163	2847	187
		700	34.6	24.2	4349	3915	180
		1000	35.8	35.8	6036	5433	169
		1500	37.6	56.4	8626	7763	153
BXRE-57E3001-D-8x	80	250	32.6	8.2	1550	1395	190
		375	33.2	12.4	2288	2060	184
		500	33.7	16.9	3004	2704	178
		700	34.6	24.2	4131	3718	171
		1000	35.8	35.8	5733	5159	160
		1500	37.6	56.4	8192	7373	145

Notes for Table 3:

1. Alternate drive currents in Table 3 are provided for reference only and are not a guarantee of performance.
2. Bridgelux maintains a ± 7% tolerance on flux measurements.
3. Typical stabilized DC performance values are provided as reference only and are not a guarantee of performance.

Performance at Commonly Used Drive Currents

Table 3: Product Performance at Commonly Used Drive Currents (Continued)

Part Number	CRI	Drive Current ¹ (mA)	Typical V _f T _c = 25°C (V)	Typical Power T _c = 25°C (W)	Typical Flux ² T _c = 25°C (lm)	Typical DC Flux ³ T _c = 85°C (lm)	Typical Efficacy T _c = 25°C (lm/W)
BXRE-65C3001-D-8x	70	250	32.6	8.2	1632	1469	200
		375	33.2	12.4	2410	2169	194
		500	33.7	16.9	3163	2847	187
		700	34.6	24.2	4349	3915	180
		1000	35.8	35.8	6036	5433	169
		1500	37.6	56.4	8626	7763	153
BXRE-65E3001-D-8x	80	250	32.6	8.2	1569	1412	192
		375	33.2	12.4	2315	2084	186
		500	33.7	16.9	3039	2735	180
		700	34.6	24.2	4179	3761	173
		1000	35.8	35.8	5800	5220	162
		1500	37.6	56.4	8289	7460	147

Notes for Table 3:

1. Alternate drive currents in Table 3 are provided for reference only and are not a guarantee of performance.
2. Bridgelux maintains a ± 7% tolerance on flux measurements.
3. Typical stabilized DC performance values are provided as reference only and are not a guarantee of performance.

Electrical Characteristics

Table 4: Electrical Characteristics

Part Number	Drive Current (mA)	Forward Voltage Pulsed, $T_c = 25^\circ\text{C}$ (V) ^{1, 2, 3, 8}			Typical Coefficient of Forward Voltage ⁴ $\Delta V_f / \Delta T_c$ (mV/ $^\circ\text{C}$)	Typical Thermal Resistance Junction to Case ^{5,6} R_{j-c} ($^\circ\text{C}/\text{W}$)	Driver Selection Voltages ⁷ (V)	
		Minimum	Typical	Maximum			V_f Min. Hot $T_c = 105^\circ\text{C}$ (V)	V_f Max. Cold $T_c = -40^\circ\text{C}$ (V)
BXRE-xxx300x-D-8x	500	31.2	33.7	36.2	-10.87	0.19	30.3	36.9
	1500	34.8	37.6	40.4	-12.13	0.30	33.8	41.2

Notes for Table 4:

- Parts are tested in pulsed conditions. $T_c = 25^\circ\text{C}$. Pulse width is 10ms.
- Voltage minimum and maximum are provided for reference only and are not a guarantee of performance.
- Bridgelux maintains a tester tolerance of $\pm 0.10\text{V}$ on forward voltage measurements.
- Typical coefficient of forward voltage tolerance is $\pm 0.1\text{mV}$ for nominal current.
- Thermal resistance values are based from test data of a 3000K 80 CRI product.
- Thermal resistance value was calculated using total electrical input power; optical power was not subtracted from input power. The thermal interface material used during testing is not included in the thermal resistance value.
- V_f min hot and max cold values are provided as reference only and are not guaranteed by test. These values are provided to aid in driver design and selection over the operating range of the product.
- This product has been designed and manufactured per IEC 62031:2018. This product has passed dielectric withstand voltage testing at 1140 V. The working voltage designated for the insulation is 70V d.c. The maximum allowable voltage across the array must be determined in the end product application.

Eye Safety

Table 5: Eye Safety Risk Group (RG) Classifications

Part Number	Drive Current (mA)	CCT ⁴			
		2700K/3000K	4000K	5000K ²	6500K ³
BXRE-xxx300x-D-8x	885	RG1	RG1	RG1	RG1
	1225	RG1	RG1	RG1	RG2
	1500	RG1	RG1	RG2	RG2

Notes for Table 5:

1. Eye safety classification for the use of Bridgelux V Series LED arrays is in accordance with specification IEC/TR 62778: Application of IEC 62471 for the assessment of blue light hazard to light sources and luminaires.
2. For products classified as RG2 at 5000K Ethr= 1530 lx.
3. For products classified as RG2 at 6500K, Ethr= 1170 lx.
4. Please contact your Bridgelux sales representative for Ethr values at specific drive currents and CCTs not listed.

Absolute Maximum Ratings

Table 6: Maximum Ratings

Parameter	Maximum Rating
LED Junction Temperature (T_j)	150°C
Storage Temperature	-40°C to +105°C
Operating Case Temperature ¹ (T_c)	105°C
Soldering Temperature ²	300°C or lower for a maximum of 6 seconds
Maximum Drive Current ³	1500 mA
Maximum Peak Pulsed Drive Current ⁴	1680mA
Maximum Reverse Voltage ⁵	-60V

Notes for Table 6:

1. For IEC 62717 requirement, please consult your Bridgelux sales representative.
2. Refer to Bridgelux Application Note AN101: Handling and Assembly of Bridgelux V Series LED Arrays
3. Arrays may be driven at higher currents however lumen maintenance may be reduced and warranty will not apply.
4. Bridgelux recommends a maximum duty cycle of 10% and pulse width of 20 ms when operating LED Arrays at maximum peak pulsed current specified. Maximum peak pulsed currents indicate values where LED Arrays can be driven without catastrophic failures.
5. Light emitting diodes are not designed to be driven in reverse voltage and will not produce light under this condition. Maximum rating provided for reference only.

Performance Curves

Figure 1: V15D Drive Current vs. Voltage

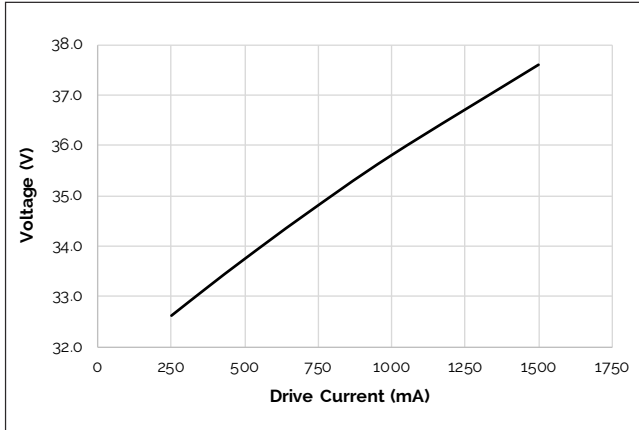

Figure 2: V15D Typical Relative Flux vs. Current

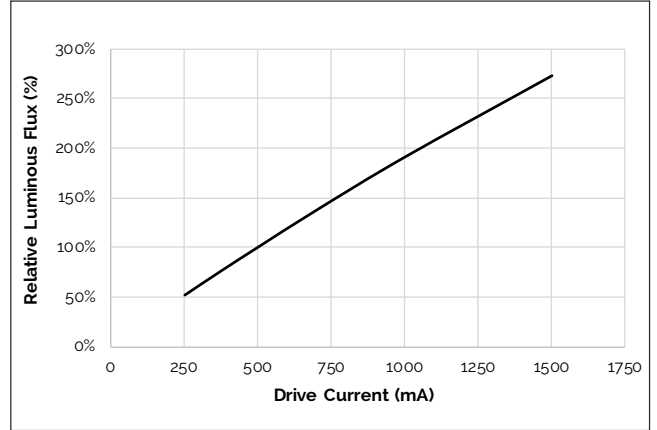

Figure 3: Typical DC Flux vs. Case Temperature

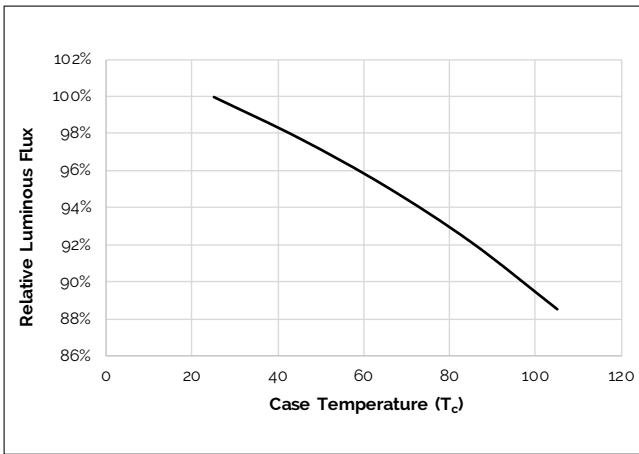

Figure 4: Typical DC ccy Shift vs. Case Temperature

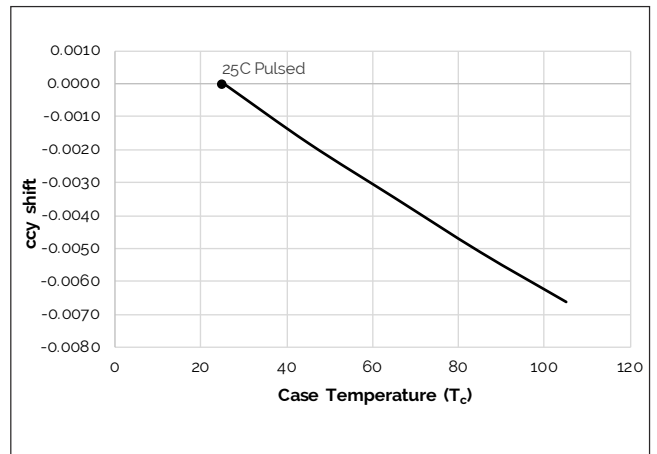
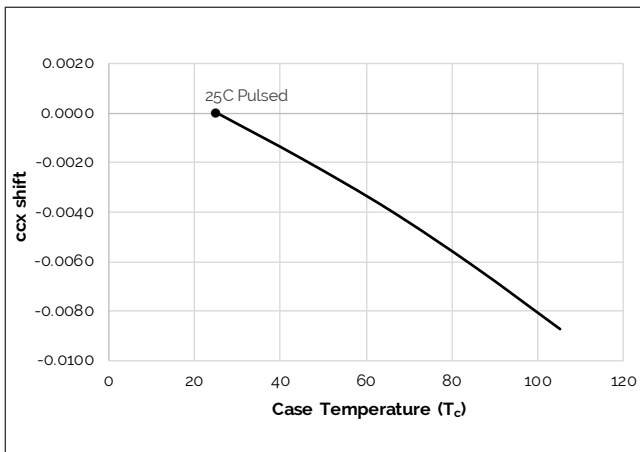

Figure 5: Typical DC ccx Shift vs. Case Temperature



Notes for Figures 1-5:

1. Bridgelux does not recommend driving high power LEDs at low currents. Doing so may produce unpredictable results. Pulse width modulation (PWM) is recommended for dimming effects.
2. Products tested under pulsed condition (10ms pulse width) at nominal test current where T_j (junction temperature) = T_c (case temperature) = 25°C.
3. Characteristics shown for warm White.

Typical Radiation Pattern

Figure 6: Typical Spatial Radiation Pattern

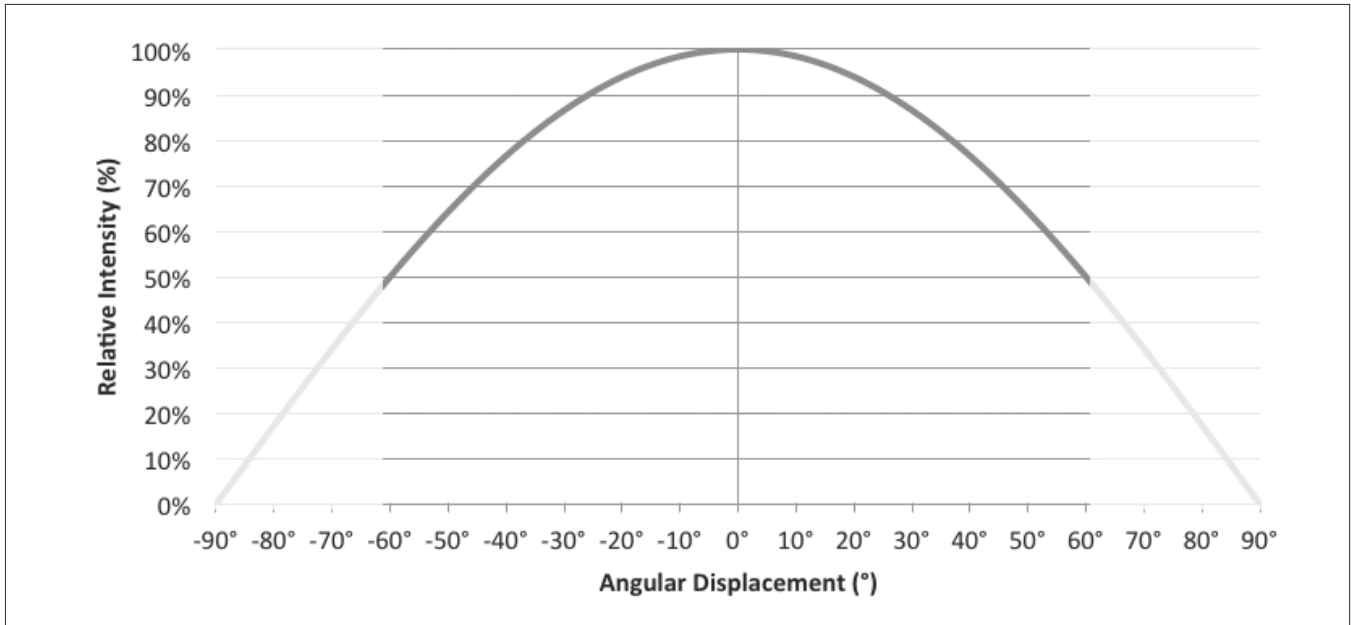

Notes for Figure 6:

1. Typical viewing angle is 120°.
2. The viewing angle is defined as the off axis angle from the centerline where intensity is ½ of the peak value.

Figure 7: Typical Polar Radiation Pattern

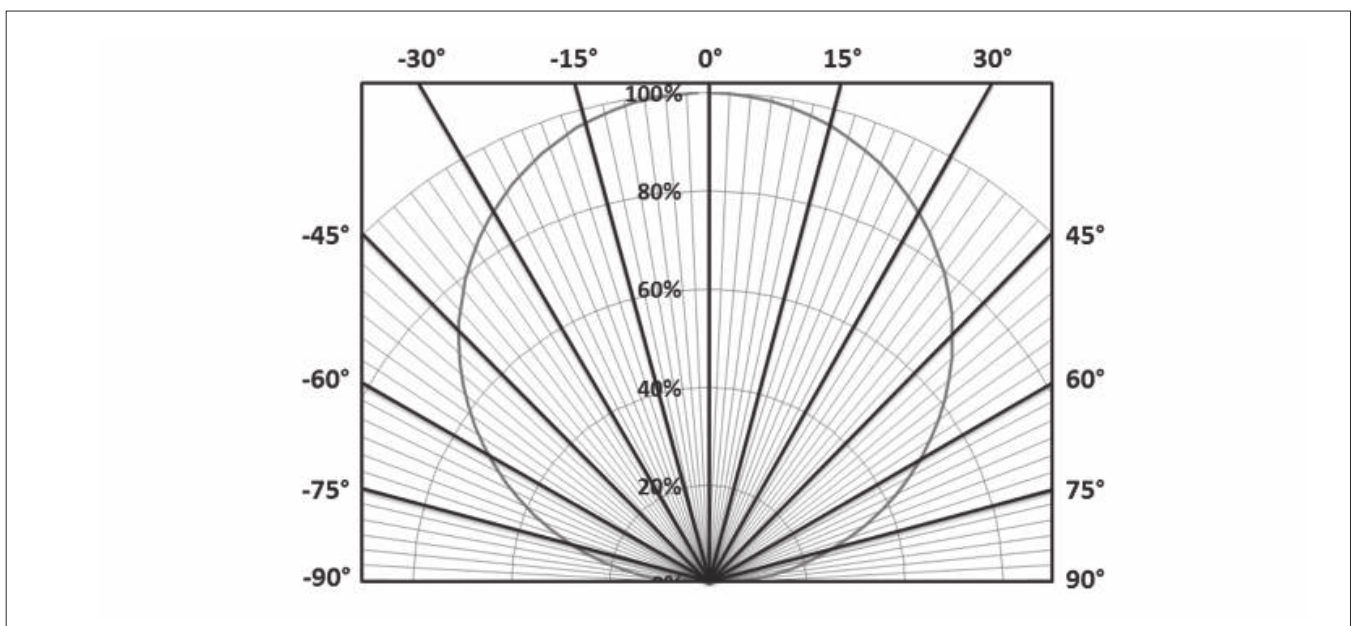

Typical Color Spectrum

Figure 8: Typical Color Spectrum

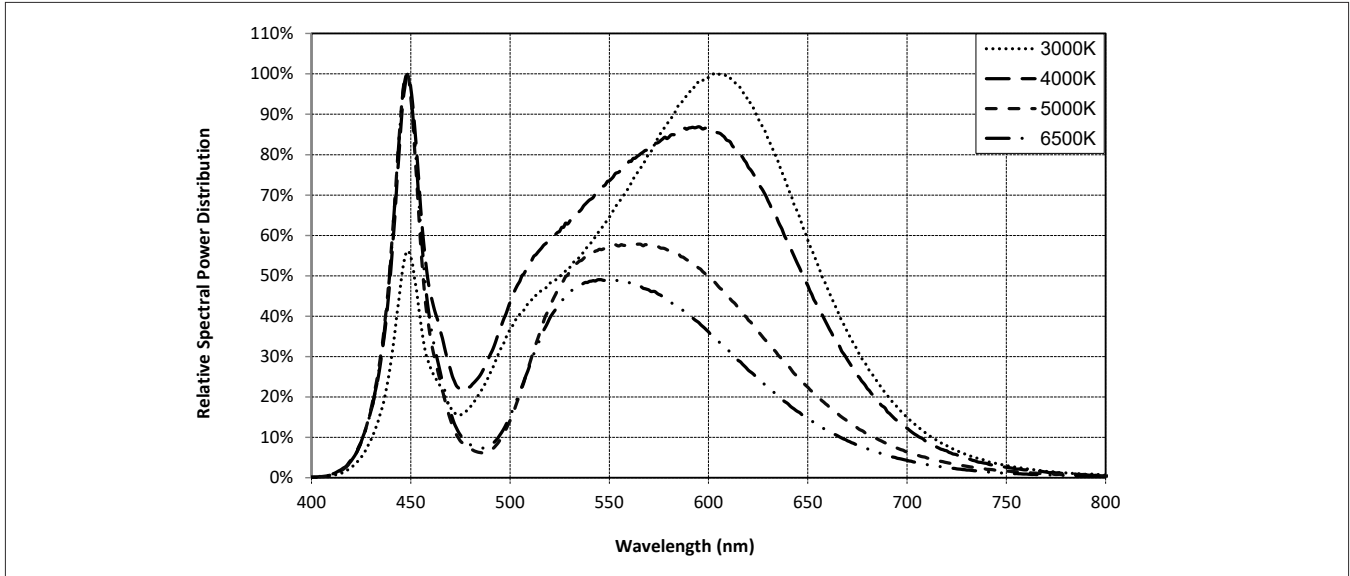

Notes for Figure 8:

1. Color spectra measured at nominal current for $T_j = T_c = 25^\circ\text{C}$.
2. Color spectra shown is 3000K and 80 CRI.
3. Color spectra shown is 4000K and 80 CRI.
4. Color spectra shown is 5000K and 70 CRI.
4. Color spectra shown is 6500K and 70 CRI.

Mechanical Dimensions

Figure 9: Drawing for V15 LED Array

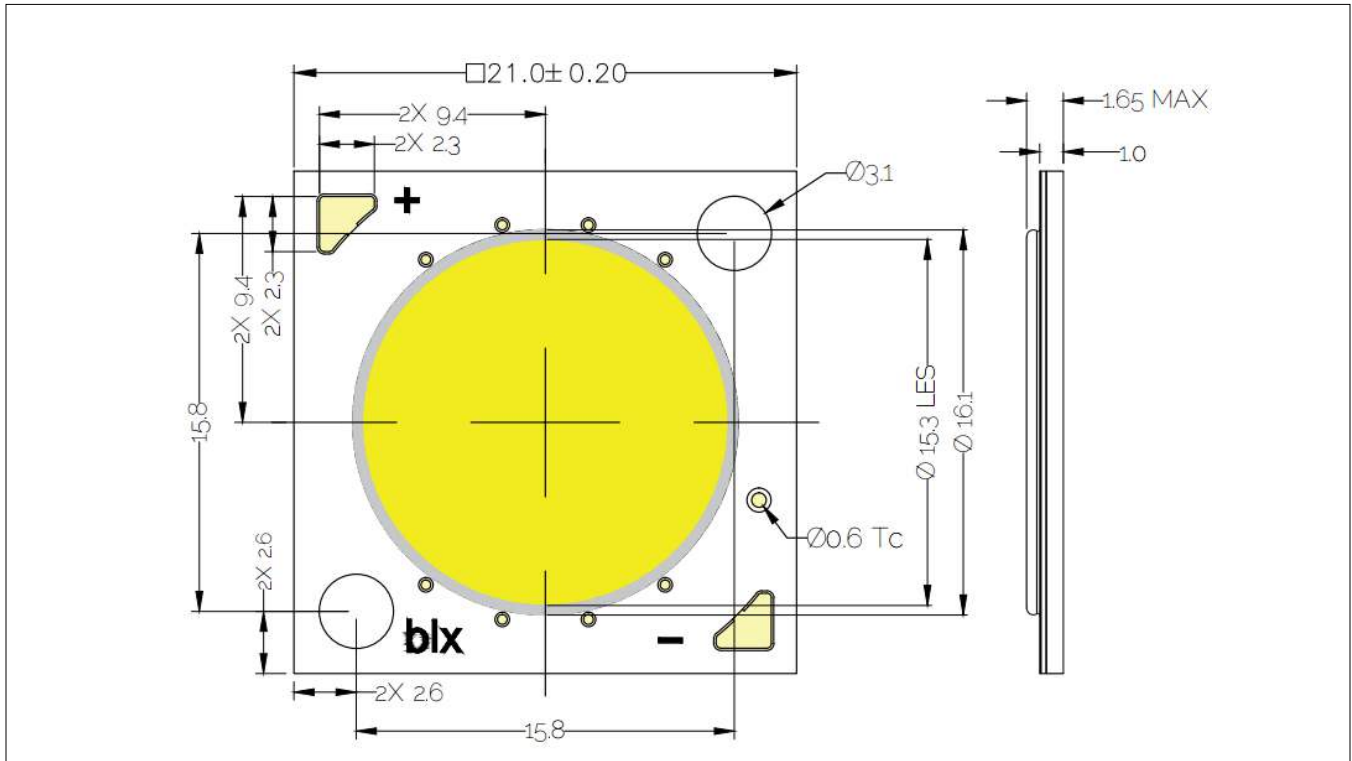

Notes for Figure 9:

1. Drawings are not to scale.
2. Drawing dimensions are in millimeters.
3. Unless otherwise specified, tolerances are ± 0.1 mm.
4. Solder pad labeled "+" denotes positive contact.
5. Refer to Application Notes AN101 for product handling, mounting and heat sink recommendations.
6. The optical center of the LED Array is nominally defined by the mechanical center of the array to a tolerance of ± 0.2 mm.
7. Bridgelux maintains a flatness of 0.10mm across the mounting surface of the array.

Color Binning Information

Figure 10: Warm and Neutral White Test Bins in xy Color Space

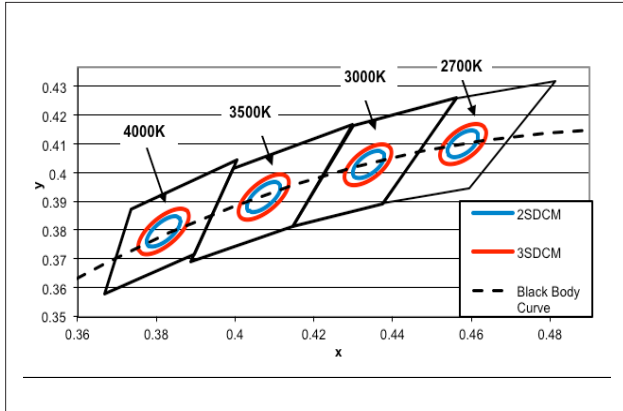

Note: Pulsed Test Conditions, $T_c = 25^\circ\text{C}$

Figure 11: Cool White Test Bins in xy Color Space

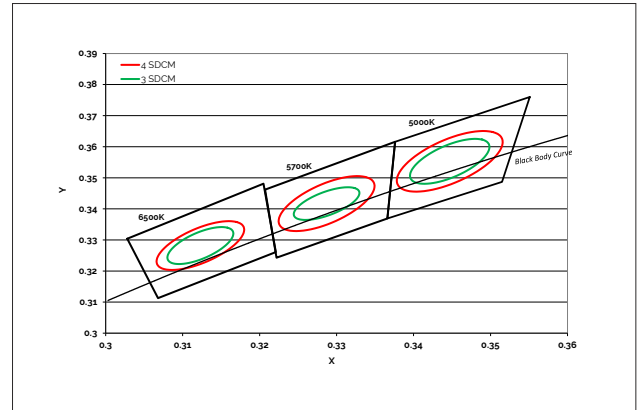

Note: Pulsed Test Conditions, $T_c = 25^\circ\text{C}$

Table 7: Warm and Neutral White xy Bin Coordinates and Associated Typical CCT

Bin Code	2700K	3000K	3500K	4000K
ANSI Bin (for reference only)	(2580K - 2870K)	(2870K - 3220K)	(3220K - 3710K)	(3710K - 4260K)
83 (3 SDCM)	(2651K - 2794K)	(2968K - 3136K)	(3369K - 3586K)	(3851K - 4130K)
82 (2 SDCM)	(2674K - 2769K)	(2995K - 3107K)	(3404K - 3548K)	(3895K - 4081K)
Center Point (x,y)	(0.4578, 0.4101)	(0.4338, 0.403)	(0.4073, 0.3917)	(0.3818, 0.3797)

Table 8: Cool White xy Bin Coordinates and Associated Typical CCT (product is hot targeted to $T_c = 85^\circ\text{C}$)

Bin Code	5000K	5700K	6500K
ANSI Bin (for reference only)	(4745K - 5311K)	(5312K - 6022K)	(6022K - 7042K)
84 (4 SDCM)	(4801K - 5282K)	(5395K - 5970K)	(6200K - 6910K)
83 (3 SDCM)	(4835K - 5215K)	(5460K - 5891K)	(6279K - 6811K)
Center Point (x,y)	(0.3447, 0.3553)	(0.3287, 0.3417)	(0.3123, 0.3282)

Note for Tables 7-8:

1. Bridgelux maintains a tolerance of +/- 0.007 on x and y color coordinates in the CIE 1931 color Space.

Packaging and Labeling

Figure 12: Drawing for V15 Packaging Tube



Notes for Figure 12:

1. Each tube holds 25 V15 COB arrays.
2. One tube is sealed in an anti-static bag. Four bags are placed in a shipping box. Depending on quantities ordered, a bigger shipping box, containing four boxes may be used to ship products.
3. Each bag and box is to be labeled as shown above.
4. Dimensions for each tube are 8.3mm (W) x 14.3mm (H) x 530mm (L). Dimensions for the anti-static bag are 75 (W) x 615 (L) x 31 (T) mm. Dimensions for the shipping box are 58.7 x 133 x 7.9 cm

Packaging and Labeling

Figure 13: Gen. 8 Product Labeling

Bridgelux COB arrays have laser markings on the back side of the substrate to help with product identification. In addition to the product identification markings, Bridgelux COB arrays also contain markings for internal Bridgelux manufacturing use only. The image below shows which markings are for customer use and which ones are for Bridgelux internal use only. The Bridgelux internal manufacturing markings are subject to change without notice, however these will not impact the form, function or performance of the COB array.

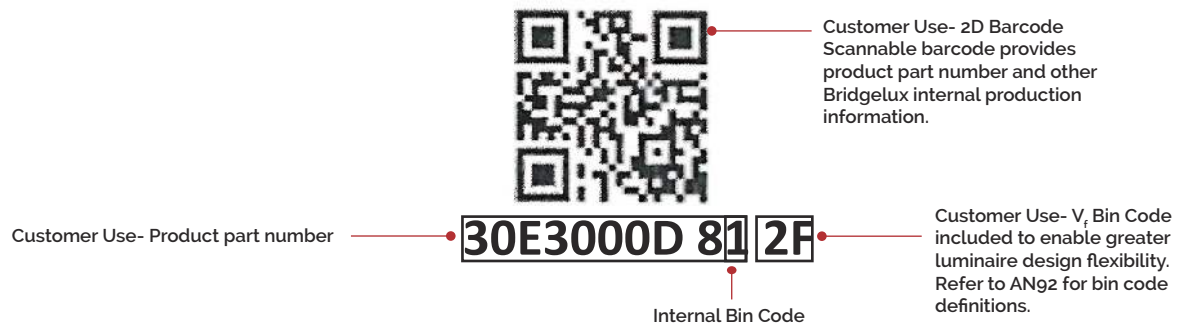

Design Resources

Application Notes

Bridgelux has developed a comprehensive set of application notes and design resources to assist customers in successfully designing with the V Series product family of LED array products. For all available application notes visit www.bridgelux.com.

Optical Source Models

Optical source models and ray set files are available for all Bridgelux products. For a list of available formats, visit www.bridgelux.com.

3D CAD Models

Three dimensional CAD models depicting the product outline of all Bridgelux V Series LED arrays are available in both IGS and STEP formats. Please contact your Bridgelux sales representative for assistance.

LM80

LM80 testing has been completed and the LM80 report is now available. Please contact your Bridgelux sales representative for LM-80 report.

Precautions

CAUTION: CHEMICAL EXPOSURE HAZARD

Exposure to some chemicals commonly used in luminaire manufacturing and assembly can cause damage to the LED array. Please consult Bridgelux Application Note AN101 for additional information.

CAUTION: RISK OF BURN

Do not touch the V Series LED array during operation. Allow the array to cool for a sufficient period of time before handling. The V Series LED array may reach elevated temperatures such that could burn skin when touched.

CAUTION

CONTACT WITH LIGHT EMITTING SURFACE (LES)

Avoid any contact with the LES. Do not touch the LES of the LED array or apply stress to the LES (yellow phosphor resin area). Contact may cause damage to the LED array.

Optics and reflectors must not be mounted in contact with the LES (yellow phosphor resin area).

Disclaimers

MINOR PRODUCT CHANGE POLICY

The rigorous qualification testing on products offered by Bridgelux provides performance assurance. Slight cosmetic changes that do not affect form, fit, or function may occur as Bridgelux continues product optimization.

STANDARD TEST CONDITIONS

Unless otherwise stated, array testing is performed at the nominal drive current.

About Bridgelux: Bridging Light and Life™

At Bridgelux, we help companies, industries and people experience the power and possibility of light. Since 2002, we've designed LED solutions that are high performing, energy efficient, cost effective and easy to integrate. Our focus is on light's impact on human behavior, delivering products that create better environments, experiences and returns—both experiential and financial. And our patented technology drives new platforms for commercial and industrial luminaires.

For more information about the company, please visit
bridgelux.com
twitter.com/Bridgelux
facebook.com/Bridgelux
youtube.com/user/Bridgelux
linkedin.com/company/bridgelux-inc-_2
WeChat ID: BridgeluxInChina



46430 Fremont Boulevard
Fremont, CA 94538 U.S.A.
Tel (925) 583-8400
www.bridgelux.com

© 2021 Bridgelux, Inc. All rights reserved. Product specifications are subject to change without notice. Bridgelux, the Bridgelux stylized logo design and Vero are registered trademarks. V Series and Decor Series are trademarks of Bridgelux, Inc. All other trademarks are the property of their respective owners.

Bridgelux Gen 8 V15 Array Series Product Data Sheet DS414 Rev. B (06/2021)