

Replaced by MRF5S9070NR1. There are no form, fit or function changes with this part replacement. N suffix added to part number to indicate transition to lead-free terminations.

MRF5S9070MR1

RF Power Field Effect Transistor N-Channel Enhancement-Mode Lateral MOSFET

Designed for broadband commercial and industrial applications with frequencies up to 1000 MHz. The high gain and broadband performance of this device make it ideal for large-signal, common-source amplifier applications in 26 volt base station equipment.

- Typical Single-Carrier N-CDMA Performance @ 880 MHz, $V_{DD} = 26$ Volts, $I_{DQ} = 600$ mA, $P_{out} = 14$ Watts Avg., IS-95 CDMA (Pilot, Sync, Paging, Traffic Codes 8 Through 13)
 Power Gain — 17.8 dB
 Drain Efficiency — 30%
 ACPR @ 750 kHz Offset — -47 dBc @ 30 kHz Bandwidth
- Capable of Handling 10:1 VSWR, @ 26 Vdc, 880 MHz, 70 Watts CW Output Power
- Characterized with Series Equivalent Large-Signal Impedance Parameters
- Integrated ESD Protection
- 200°C Capable Plastic Package
- In Tape and Reel. R1 Suffix = 500 Units per 24 mm, 13 inch Reel.

**880 MHz, 70 W, 26 V
 SINGLE N-CDMA
 LATERAL N-CHANNEL
 BROADBAND
 RF POWER MOSFET**

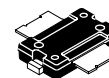

**CASE 1265-08, STYLE 1
 TO-270-2
 PLASTIC**

ARCHIVE INFORMATION

ARCHIVE INFORMATION

Table 1. Maximum Ratings

Rating	Symbol	Value	Unit
Drain-Source Voltage	V_{DSS}	- 0.5, +68	Vdc
Gate-Source Voltage	V_{GS}	- 0.5, +15	Vdc
Total Device Dissipation @ $T_C = 25^\circ\text{C}$ Derate above 25°C	P_D	219 1.25	W W/°C
Storage Temperature Range	T_{stg}	- 65 to +150	°C
Operating Junction Temperature	T_J	200	°C

Table 2. Thermal Characteristics

Characteristic	Symbol	Value ⁽¹⁾	Unit
Thermal Resistance, Junction to Case Case Temperature 80°C, 70 W CW Case Temperature 78°C, 14 W CW	$R_{\theta JC}$	0.80 0.93	°C/W

Table 3. ESD Protection Characteristics

Test Methodology	Class
Human Body Model (per JESD22-A114)	2 (Minimum)
Machine Model (per EIA/JESD22-A115)	A (Minimum)
Charge Device Model (per JESD22-C101)	IV (Minimum)

Table 4. Moisture Sensitivity Level

Test Methodology	Rating	Package Peak Temperature	Unit
Per JESD 22-A113, IPC/JEDEC J-STD-020	1	260	°C

1. Refer to AN1955/D, *Thermal Measurement Methodology of RF Power Amplifiers*. Go to <http://www.freescale.com/rf>.
 Select Documentation/Application Notes - AN1955.

NOTE - CAUTION - MOS devices are susceptible to damage from electrostatic charge. Reasonable precautions in handling and packaging MOS devices should be observed.

Table 5. Electrical Characteristics ($T_C = 25^\circ\text{C}$ unless otherwise noted)

Characteristic	Symbol	Min	Typ	Max	Unit
Off Characteristics					
Zero Gate Voltage Drain Leakage Current ($V_{DS} = 68\text{ Vdc}$, $V_{GS} = 0\text{ Vdc}$)	I_{DSS}	—	—	10	μAdc
Zero Gate Voltage Drain Leakage Current ($V_{DS} = 26\text{ Vdc}$, $V_{GS} = 0\text{ Vdc}$)	I_{DSS}	—	—	1	μAdc
Gate-Source Leakage Current ($V_{GS} = 5\text{ Vdc}$, $V_{DS} = 0\text{ Vdc}$)	I_{GSS}	—	—	1	μAdc

On Characteristics

Gate Threshold Voltage ($V_{DS} = 10\text{ Vdc}$, $I_D = 200\ \mu\text{A}$)	$V_{GS(th)}$	2	2.7	4	Vdc
Gate Quiescent Voltage ($V_{DS} = 26\text{ Vdc}$, $I_D = 600\text{ mAdc}$)	$V_{GS(Q)}$	—	3.7	—	Vdc
Drain-Source On-Voltage ($V_{GS} = 10\text{ Vdc}$, $I_D = 1.0\text{ Adc}$)	$V_{DS(on)}$	—	0.18	0.22	Vdc
Forward Transconductance ($V_{DS} = 10\text{ Vdc}$, $I_D = 4\text{ Adc}$)	g_{fs}	—	4.7	—	S

Dynamic Characteristic

Input Capacitance ($V_{DS} = 26\text{ Vdc} \pm 30\text{ mV(rms)ac}$ @ 1 MHz, $V_{GS} = 0\text{ Vdc}$)	C_{iss}	—	126	—	pF
Output Capacitance ($V_{DS} = 26\text{ Vdc} \pm 30\text{ mV(rms)ac}$ @ 1 MHz, $V_{GS} = 0\text{ Vdc}$)	C_{oss}	—	34	—	pF
Reverse Transfer Capacitance ($V_{DS} = 26\text{ Vdc} \pm 30\text{ mV(rms)ac}$ @ 1 MHz, $V_{GS} = 0\text{ Vdc}$)	C_{rss}	—	1.37	—	pF

Functional Tests (In Freescale Test Fixture, 50 ohm system) $V_{DD} = 26\text{ Vdc}$, $I_{DQ} = 600\text{ mA}$, $P_{out} = 14\text{ W Avg.}$, $f = 880\text{ MHz}$, Single-Carrier N-CDMA, 1.2288 MHz Channel Bandwidth Carrier. ACPR measured in 30 kHz Channel Bandwidth @ $\pm 750\text{ kHz}$ Offset. Peak/Avg. Ratio = 9.8 dB @ 0.01% Probability on CCDF

Power Gain	G_{ps}	17	17.8	—	dB
Drain Efficiency	η_D	29	30	—	%
Adjacent Channel Power Ratio	ACPR	—	-47	-45	dBc
Input Return Loss	IRL	—	-19	-9	dB

Typical GSM CW Performances (In Freescale GSM Test Fixture Optimized for 921-960 MHz, 50 ohm system) $V_{DD} = 26\text{ Vdc}$, $I_{DQ} = 400\text{ mA}$, $P_{out} = 60\text{ W}$, $f = 921-960\text{ MHz}$

Power Gain	G_{ps}	—	16.4	—	dB
Drain Efficiency	η_D	—	62	—	%
Input Return Loss	IRL	—	-12	—	dB
P_{out} @ 1 dB Compression Point ($f = 940\text{ MHz}$)	P1dB	—	68	—	W

Typical GSM EDGE Performances (In Freescale GSM EDGE Test Fixture Optimized for 921-960 MHz, 50 ohm system)

$V_{DD} = 26\text{ Vdc}$, $I_{DQ} = 400\text{ mA}$, $P_{out} = 25\text{ W Avg.}$, $f = 921-960\text{ MHz}$, GSM EDGE Signal

Power Gain	G_{ps}	—	17	—	dB
Drain Efficiency	η_D	—	44	—	%
Error Vector Magnitude	EVM	—	1.5	—	%
Spectral Regrowth at 400 kHz Offset	SR1	—	-62	—	dBc
Spectral Regrowth at 600 kHz Offset	SR2	—	-78	—	dBc

(continued)

Table 5. Electrical Characteristics ($T_C = 25^\circ\text{C}$ unless otherwise noted) (continued)

Characteristic	Symbol	Min	Typ	Max	Unit
Typical GSM CW Performances (In Freescale GSM Test Fixture Optimized for 865-895 MHz, 50 ohm system) $V_{DD} = 26\text{ Vdc}$, $I_{DQ} = 400\text{ mA}$, $P_{out} = 60\text{ W}$, $f = 865\text{ -}895\text{ MHz}$					
Power Gain	G_{ps}	—	16.4	—	dB
Drain Efficiency	η_D	—	59	—	%
Input Return Loss	IRL	—	-15	—	dB
P_{out} @ 1 dB Compression Point ($f = 880\text{ MHz}$)	P1dB	—	71	—	W

Typical GSM EDGE Performances (In Freescale GSM EDGE Test Fixture Optimized for 865-895 MHz, 50 ohm system) $V_{DD} = 26\text{ Vdc}$, $I_{DQ} = 400\text{ mA}$, $P_{out} = 25\text{ W Avg.}$, $f = 865\text{ -}895\text{ MHz}$, GSM EDGE Signal

Power Gain	G_{ps}	—	17	—	dB
Drain Efficiency	η_D	—	41	—	%
Error Vector Magnitude	EVM	—	1.35	—	%
Spectral Regrowth at 400 kHz Offset	SR1	—	-66	—	dBc
Spectral Regrowth at 600 kHz Offset	SR2	—	-81	—	dBc

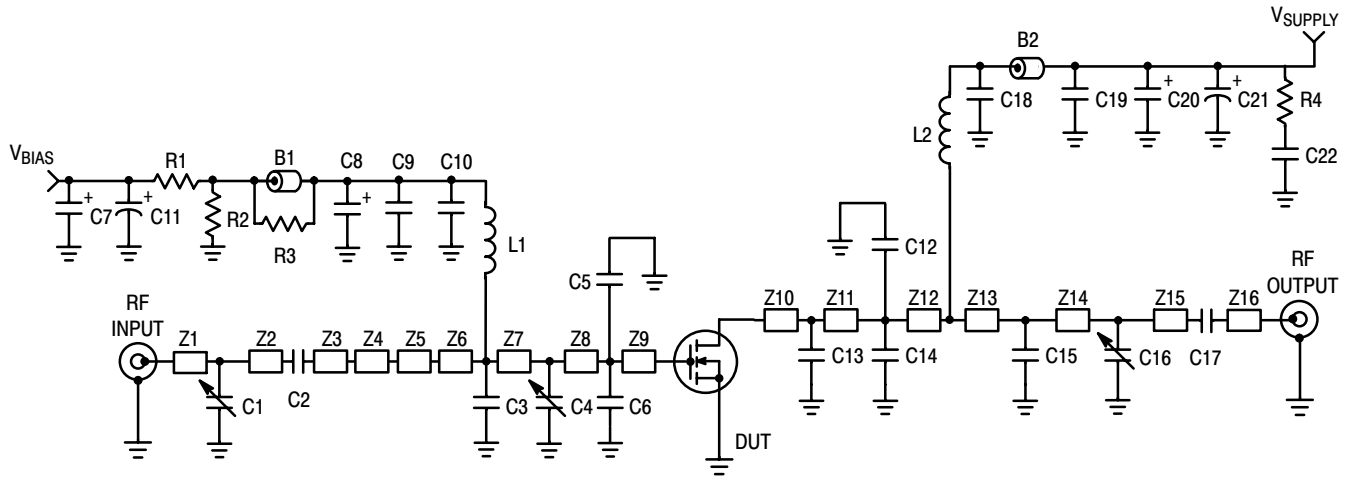

Z1	0.140" x 0.060" Microstrip	Z10	0.245" x 0.270" Microstrip
Z2	0.141" x 0.060" Microstrip	Z11	0.110" x 0.270" Microstrip
Z3	0.280" x 0.060" Microstrip	Z12	0.055" x 0.270" Microstrip
Z4	0.500" x 0.100" Microstrip	Z13	0.512" x 0.060" Microstrip
Z5	0.530" x 0.270" Microstrip	Z14	0.106" x 0.060" Microstrip
Z6	0.155" x 0.270" x 0.530" Taper	Z15	0.930" x 0.060" Microstrip
Z7	0.376" x 0.530" Microstrip	Z16	0.365" x 0.060" Microstrip
Z8	0.116" x 0.530" Microstrip	PCB	Taconic RF-35, 0.030", $\epsilon_r = 3.5$
Z9	0.055" x 0.530" Microstrip		

Figure 1. MRF5S9070MR1 Test Circuit Schematic

Table 6. MRF5S9070MR1 Test Circuit Component Designations and Values

Part	Description	Part Number	Manufacturer
B1	Small Ferrite Bead, Surface Mount	2743019447	Fair-Rite
B2	Large Ferrite Bead, Surface Mount	2743021447	Fair-Rite
C1	0.6 - 6.0 pF Variable Capacitor, Gigatrim	272715L	Johanson
C2	16 pF Chip Capacitor	100B160JP500X	ATC
C3	7.5 pF Chip Capacitor	100B7R5JP500X	ATC
C4, C16	0.8 - 8.0 pF Variable Capacitor, Gigatrim	272915L	Johanson
C5, C6	15 pF Chip Capacitors	100B150JP500X	ATC
C7, C8, C20	10 μ F, 35 V Tantalum Capacitors	T491D106K035AS	Kemet
C9, C19, C22	0.58 μ F Chip Capacitors	700A561MP150X	ATC
C10, C18	18 pF Chip Capacitors	100B180JP500X	ATC
C11	100 μ F, 50 V Electrolytic Capacitor	515D107M050BB6A	Vishay-Dale
C12, C14	13 pF Chip Capacitors	100B130JP500X	ATC
C13	0.7 pF Chip Capacitor	100B0R7BP500X	ATC
C15	3.9 pF Chip Capacitor	100B3R9JP500X	ATC
C17	22 pF Chip Capacitor	100B180JP500X	ATC
C21	470 μ F, 63 V Electrolytic Capacitor	SME63VB471M12X25LL	United Chemi-Con
L1, L2	12.5 nH Surface Mount Inductors	A04T-5	Coilcraft
R1	1 k Ω Chip Resistor	CRCW12061001F100	Vishay-Dale
R2	560 k Ω Chip Resistor	CRCW12065603F100	Vishay-Dale
R3	12 Ω Chip Resistor	CRCW120612R0F100	Vishay-Dale
R4	27 Ω Chip Resistor	CRCW120627R0F100	Vishay-Dale

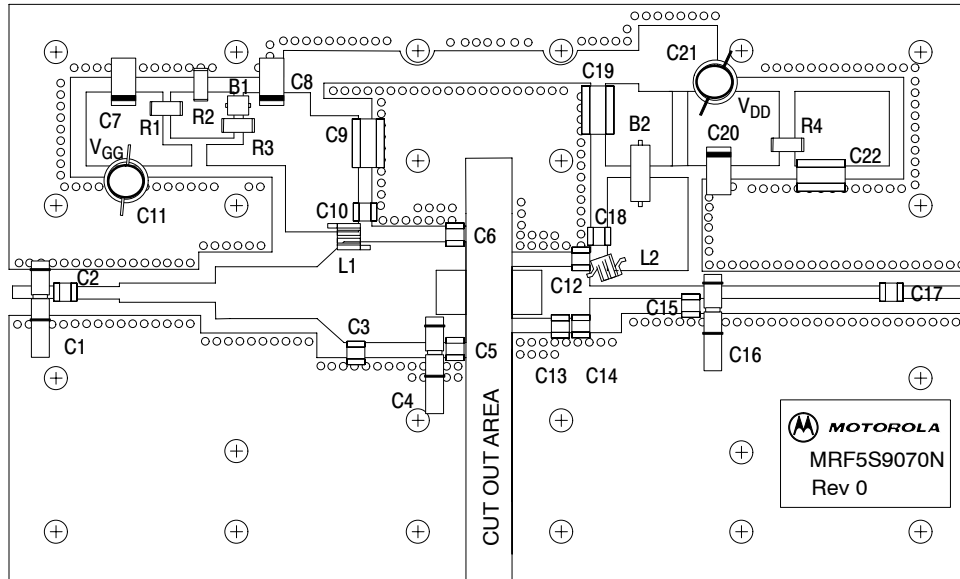

Freescale has begun the transition of marking Printed Circuit Boards (PCBs) with the Freescale Semiconductor signature/logo. PCBs may have either Motorola or Freescale markings during the transition period. These changes will have no impact on form, fit or function of the current product.

Figure 2. MRF5S9070MR1 Test Circuit Component Layout

TYPICAL CHARACTERISTICS

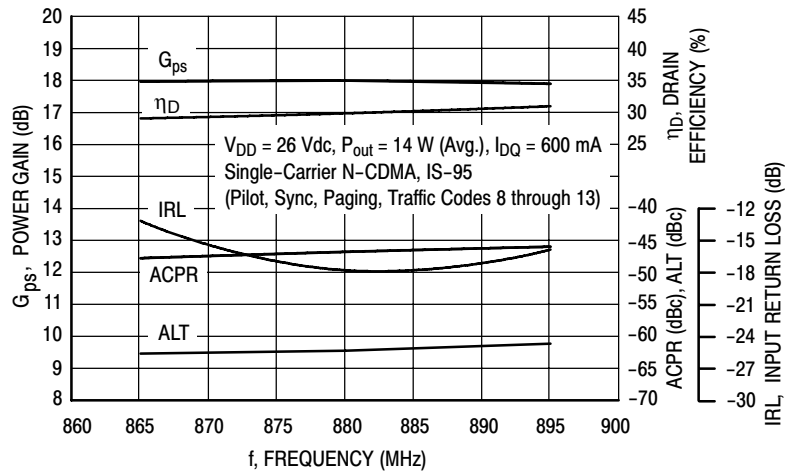

Figure 3. Class AB Broadband Performance

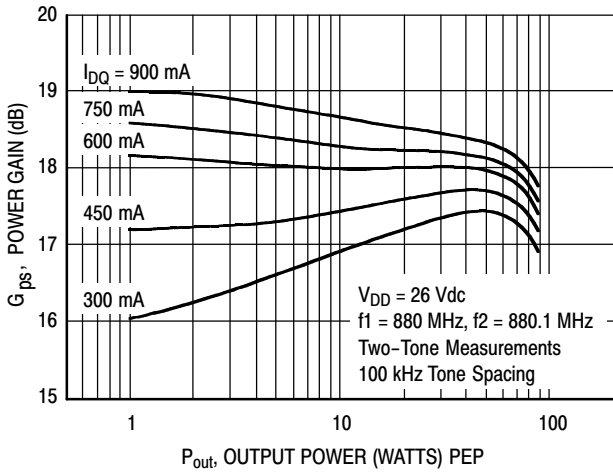

Figure 4. Two-Tone Power Gain versus Output Power

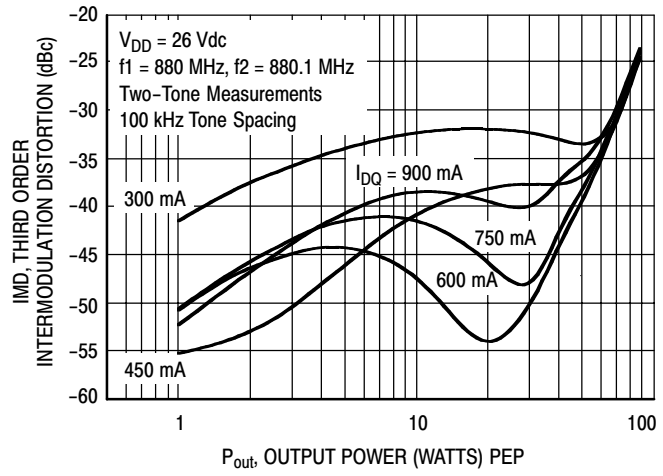

Figure 5. Third Order Intermodulation Distortion versus Output Power

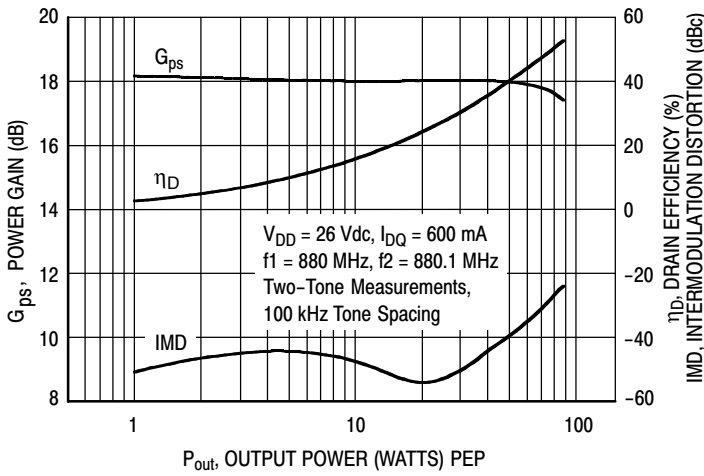

Figure 6. Power Gain, Drain Efficiency and IMD versus Output Power

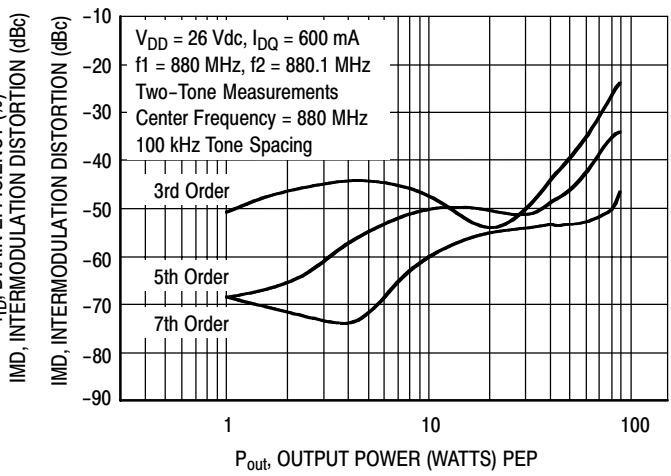

Figure 7. Intermodulation Distortion Products versus Output Power

ARCHIVE INFORMATION

ARCHIVE INFORMATION

TYPICAL CHARACTERISTICS

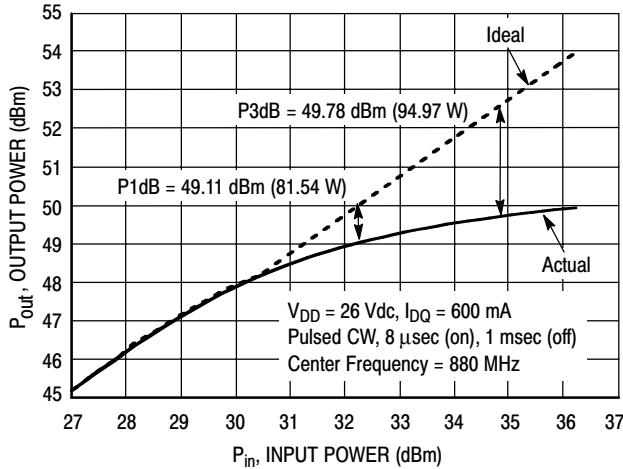

Figure 8. Pulse CW Output Power versus Input Power

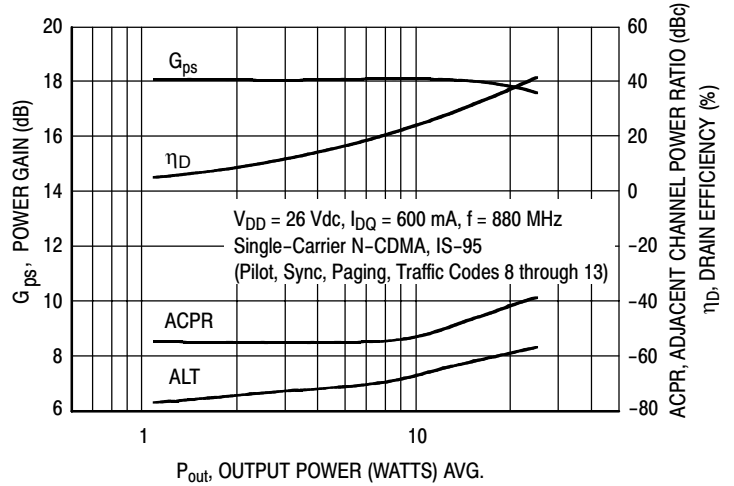

Figure 9. N-CDMA ACPR, Power Gain and Drain Efficiency versus Output Power

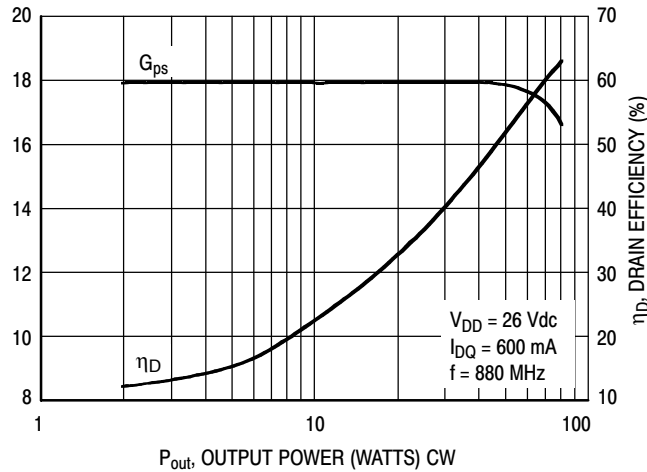
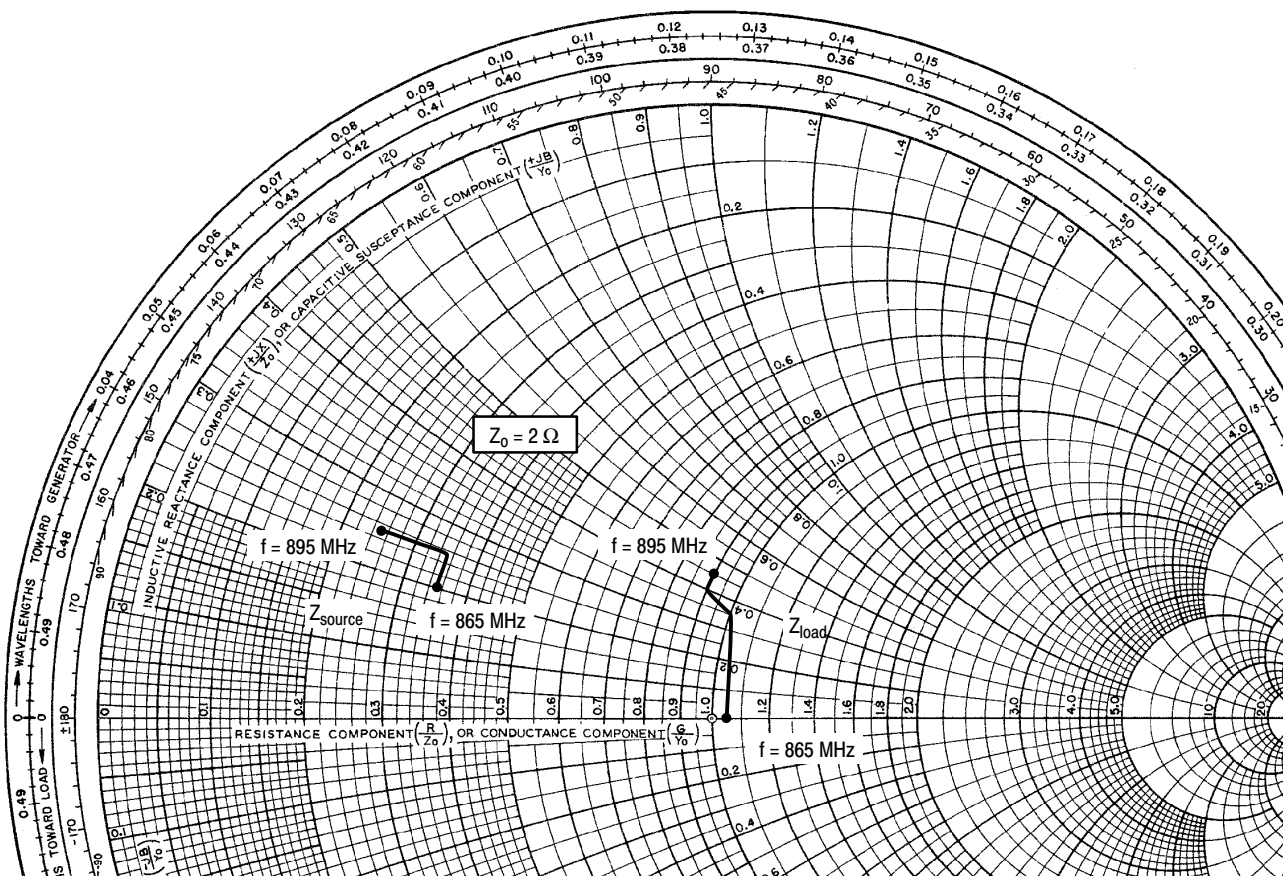

Figure 10. Power Gain and Drain Efficiency versus CW Output Power

ARCHIVE INFORMATION

ARCHIVE INFORMATION



$V_{DD} = 26 \text{ Vdc}$, $I_{DQ} = 600 \text{ mA}$, $P_{out} = 14 \text{ W Avg.}$

f MHz	Z_{source} Ω	Z_{load} Ω
865	$0.7 + j0.4$	$2.1 + j0.6$
875	$0.7 + j0.5$	$2.0 + j0.7$
885	$0.6 + j0.5$	$1.8 + j0.8$
895	$0.5 + j0.5$	$1.8 + j0.9$

Z_{source} = Test circuit impedance as measured from gate to ground.

Z_{load} = Test circuit impedance as measured from drain to ground.

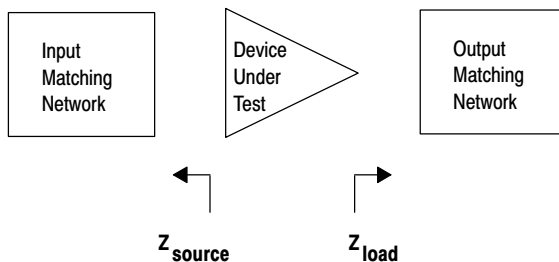
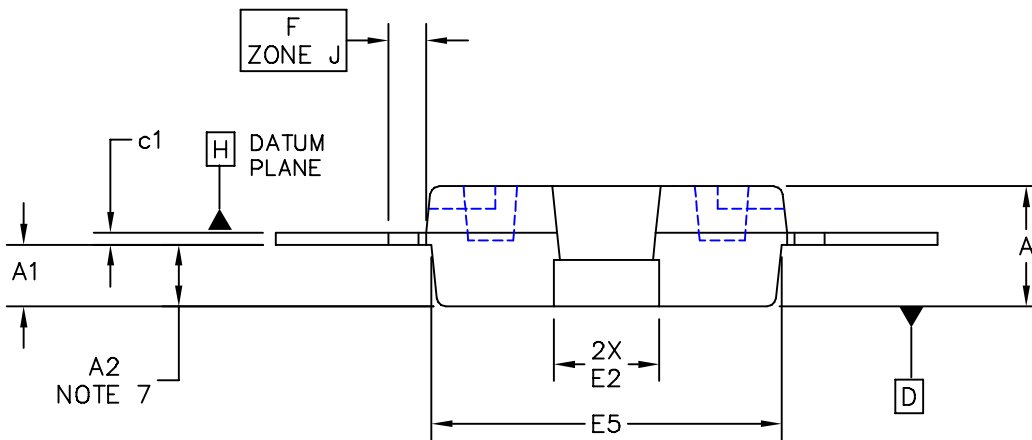
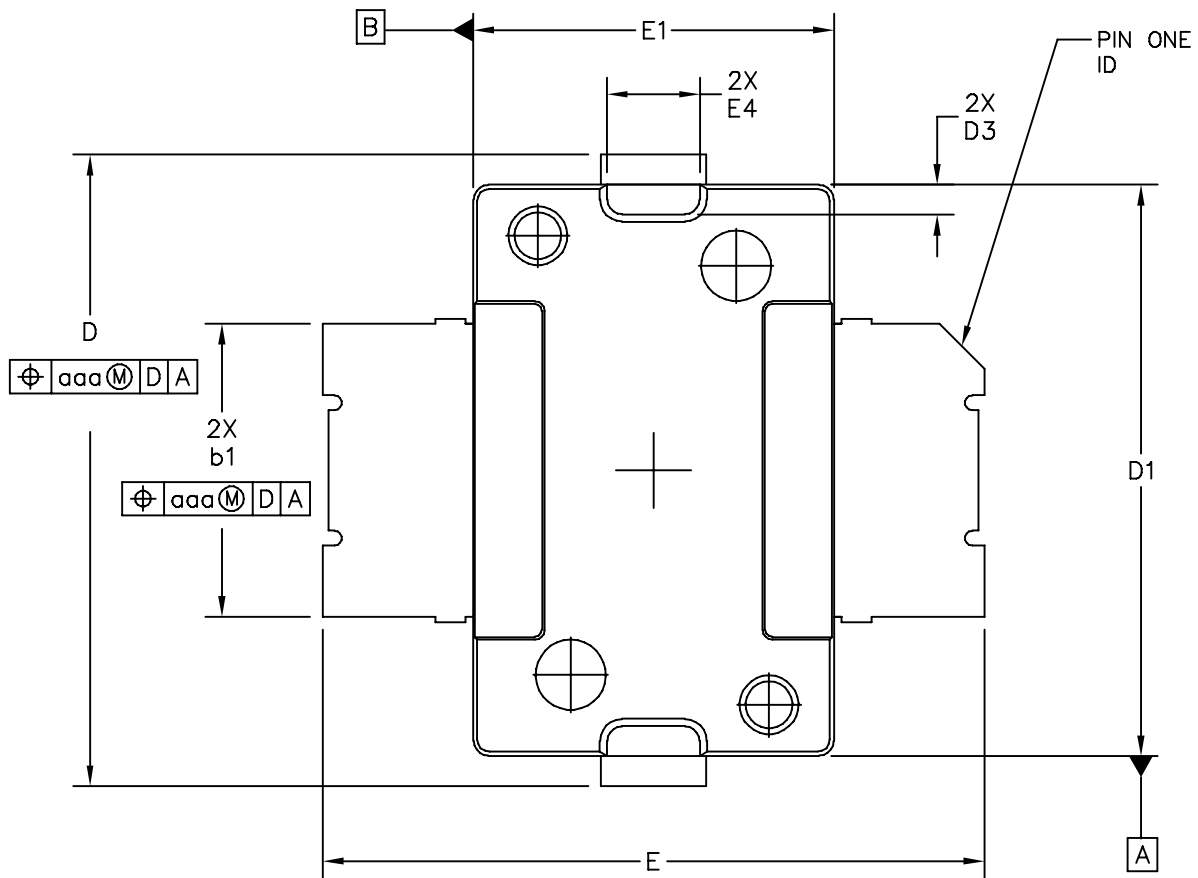
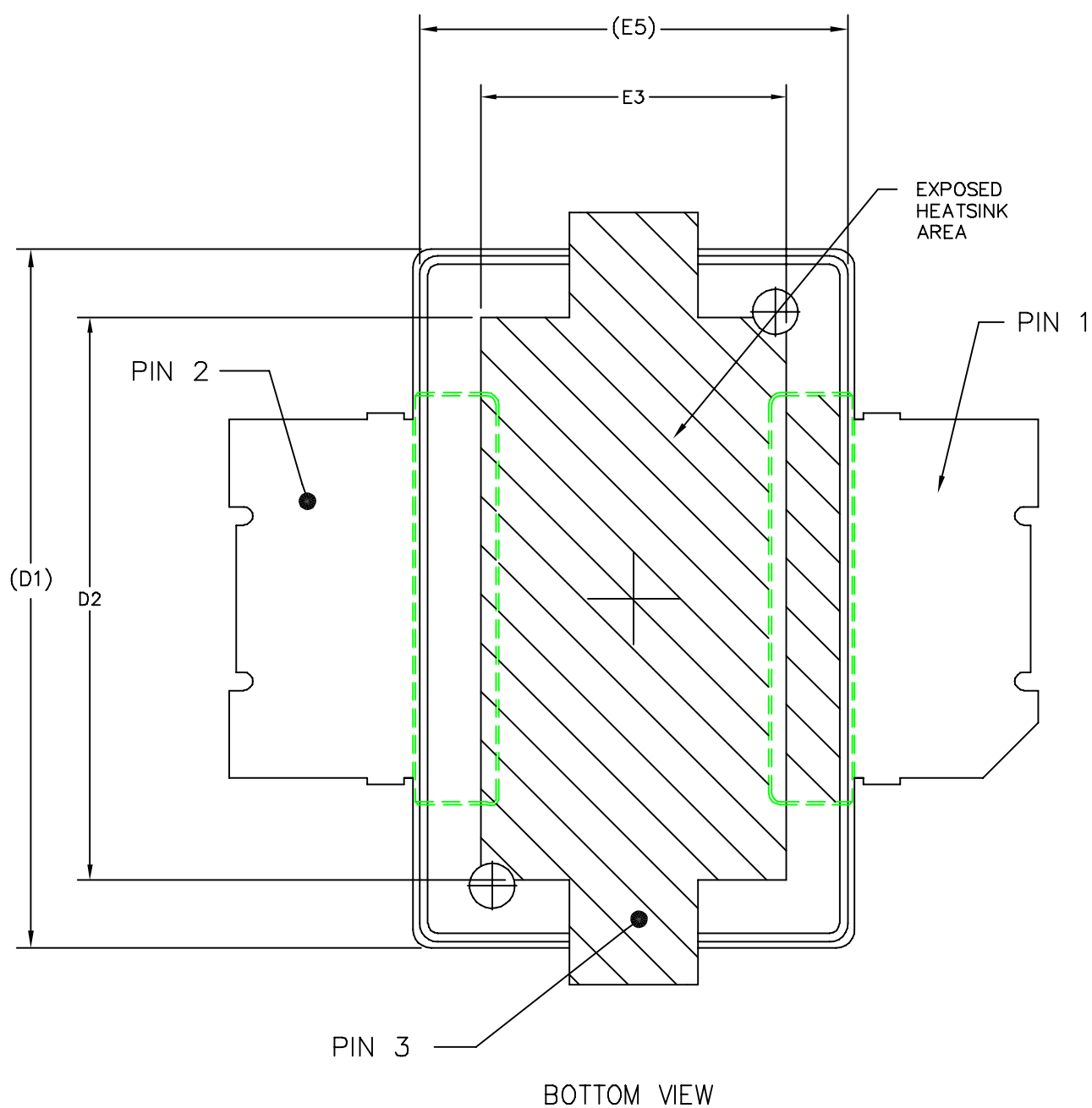

Figure 11. Series Equivalent Source and Load Impedance

PACKAGE DIMENSIONS



© FREESCALE SEMICONDUCTOR, INC. ALL RIGHTS RESERVED.	MECHANICAL OUTLINE	PRINT VERSION NOT TO SCALE	
TITLE: TO-270 SURFACE MOUNT	DOCUMENT NO: 98ASH98117A	REV: J	
	CASE NUMBER: 1265-08	01 APR 2005	
	STANDARD: NON-JEDEC		



© FREESCALE SEMICONDUCTOR, INC. ALL RIGHTS RESERVED.	MECHANICAL OUTLINE	PRINT VERSION NOT TO SCALE	
TITLE: <div style="text-align: center; padding: 5px;"> TO-270 SURFACE MOUNT </div>	DOCUMENT NO: 98ASH98117A		REV: J
	CASE NUMBER: 1265-08		01 APR 2005
	STANDARD: NON-JEDEC		



NOTES:

1. CONTROLLING DIMENSION: INCH
2. INTERPRET DIMENSIONS AND TOLERANCES PER ASME Y14.5M-1994.
3. DATUM PLANE -H- IS LOCATED AT TOP OF LEAD AND IS COINCIDENT WITH THE LEAD WHERE THE LEAD EXITS THE PLASTIC BODY AT THE TOP OF THE PARTING LINE.
4. DIMENSIONS "D1" AND "E1" DO NOT INCLUDE MOLD PROTRUSION. ALLOWABLE PROTRUSION IS .006 PER SIDE. DIMENSIONS "D1 AND "E1" DO INCLUDE MOLD MISMATCH AND ARE DETERMINED AT DATUM PLANE -H-.
5. DIMENSION "b1" DOES NOT INCLUDE DAMBAR PROTRUSION. ALLOWABLE DAMBAR PROTRUSION SHALL BE .005 TOTAL IN EXCESS OF THE "b1" DIMENSION AT MAXIMUM MATERIAL CONDITION.
6. DATUMS -A- AND -B- TO BE DETERMINED AT DATUM PLANE -H-.
7. DIMENSION "A2" APPLIES WITHIN ZONE "J" ONLY.
8. DIMENSIONS "D" AND "E2" DO NOT INCLUDE MOLD PROTRUSION. OVERALL LENGTH INCLUDING MOLD PROTRUSION SHOULD NOT EXCEED 0.430 INCH FOR DIMENSION "D" AND 0.080 INCH FOR DIMENSION "E2". DIMENSIONS "D" AND "E2" DO INCLUDE MOLD MISMATCH AND ARE DETERMINED AT DATUM PLANE -D-.

STYLE 1:

- PIN 1 - DRAIN
- PIN 2 - GATE
- PIN 3 - SOURCE

DIM	INCH		MILLIMETER		DIM	INCH		MILLIMETER	
	MIN	MAX	MIN	MAX		MIN	MAX	MIN	MAX
A	.078	.082	1.98	2.08	F	.025 BSC		0.64 BSC	
A1	.039	.043	0.99	1.09	b1	.193	.199	4.90	5.06
A2	.040	.042	1.02	1.07	c1	.007	.011	0.18	0.28
D	.416	.424	10.57	10.77	aaa	.004		0.10	
D1	.378	.382	9.60	9.70					
D2	.290	.320	7.37	8.13					
D3	.016	.024	0.41	0.61					
E	.436	.444	11.07	11.28					
E1	.238	.242	6.04	6.15					
E2	.066	.074	1.68	1.88					
E3	.150	.180	3.81	4.57					
E4	.058	.066	1.47	1.68					
E5	.231	.235	5.87	5.97					

© FREESCALE SEMICONDUCTOR, INC. ALL RIGHTS RESERVED.		MECHANICAL OUTLINE		PRINT VERSION NOT TO SCALE	
TITLE: TO-270 SURFACE MOUNT			DOCUMENT NO: 98ASH98117A		REV: J
			CASE NUMBER: 1265-08		01 APR 2005
			STANDARD: NON-JEDEC		

How to Reach Us:

Home Page:

www.freescale.com

E-mail:

support@freescale.com

USA/Europe or Locations Not Listed:

Freescale Semiconductor
 Technical Information Center, CH370
 1300 N. Alma School Road
 Chandler, Arizona 85224
 +1-800-521-6274 or +1-480-768-2130
support@freescale.com

Europe, Middle East, and Africa:

Freescale Halbleiter Deutschland GmbH
 Technical Information Center
 Schatzbogen 7
 81829 Muenchen, Germany
 +44 1296 380 456 (English)
 +46 8 52200080 (English)
 +49 89 92103 559 (German)
 +33 1 69 35 48 48 (French)
support@freescale.com

Japan:

Freescale Semiconductor Japan Ltd.
 Headquarters
 ARCO Tower 15F
 1-8-1, Shimo-Meguro, Meguro-ku,
 Tokyo 153-0064
 Japan
 0120 191014 or +81 3 5437 9125
support.japan@freescale.com

Asia/Pacific:

Freescale Semiconductor Hong Kong Ltd.
 Technical Information Center
 2 Dai King Street
 Tai Po Industrial Estate
 Tai Po, N.T., Hong Kong
 +800 2666 8080
support.asia@freescale.com

For Literature Requests Only:

Freescale Semiconductor Literature Distribution Center
 P.O. Box 5405
 Denver, Colorado 80217
 1-800-441-2447 or 303-675-2140
 Fax: 303-675-2150
LDCForFreescaleSemiconductor@hibbertgroup.com

RoHS-compliant and/or Pb-free versions of Freescale products have the functionality and electrical characteristics of their non-RoHS-compliant and/or non-Pb-free counterparts. For further information, see <http://www.freescale.com> or contact your Freescale sales representative.

For information on Freescale's Environmental Products program, go to <http://www.freescale.com/epp>.

Information in this document is provided solely to enable system and software implementers to use Freescale Semiconductor products. There are no express or implied copyright licenses granted hereunder to design or fabricate any integrated circuits or integrated circuits based on the information in this document.

Freescale Semiconductor reserves the right to make changes without further notice to any products herein. Freescale Semiconductor makes no warranty, representation or guarantee regarding the suitability of its products for any particular purpose, nor does Freescale Semiconductor assume any liability arising out of the application or use of any product or circuit, and specifically disclaims any and all liability, including without limitation consequential or incidental damages. "Typical" parameters that may be provided in Freescale Semiconductor data sheets and/or specifications can and do vary in different applications and actual performance may vary over time. All operating parameters, including "Typicals", must be validated for each customer application by customer's technical experts. Freescale Semiconductor does not convey any license under its patent rights nor the rights of others. Freescale Semiconductor products are not designed, intended, or authorized for use as components in systems intended for surgical implant into the body, or other applications intended to support or sustain life, or for any other application in which the failure of the Freescale Semiconductor product could create a situation where personal injury or death may occur. Should Buyer purchase or use Freescale Semiconductor products for any such unintended or unauthorized application, Buyer shall indemnify and hold Freescale Semiconductor and its officers, employees, subsidiaries, affiliates, and distributors harmless against all claims, costs, damages, and expenses, and reasonable attorney fees arising out of, directly or indirectly, any claim of personal injury or death associated with such unintended or unauthorized use, even if such claim alleges that Freescale Semiconductor was negligent regarding the design or manufacture of the part.

Freescale™ and the Freescale logo are trademarks of Freescale Semiconductor, Inc. All other product or service names are the property of their respective owners.
 © Freescale Semiconductor, Inc. 2006. All rights reserved.

RoHS-compliant and/or Pb-free versions of Freescale products have the functionality and electrical characteristics of their non-RoHS-compliant and/or non-Pb-free counterparts. For further information, see <http://www.freescale.com> or contact your Freescale sales representative.

For information on Freescale's Environmental Products program, go to <http://www.freescale.com/epp>.