

Automotive-grade 10 A, 600 V, short-circuit rugged IGBT with Ultrafast diode

Datasheet - production data

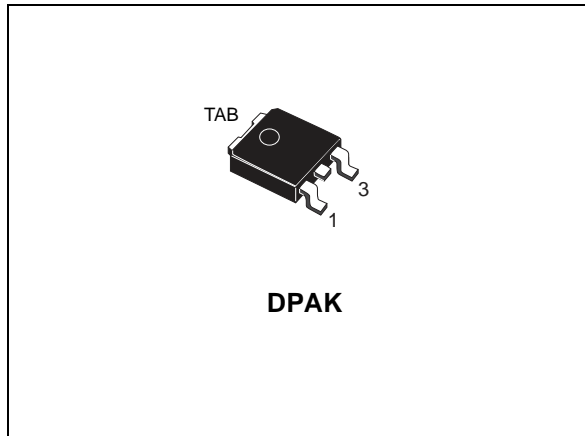
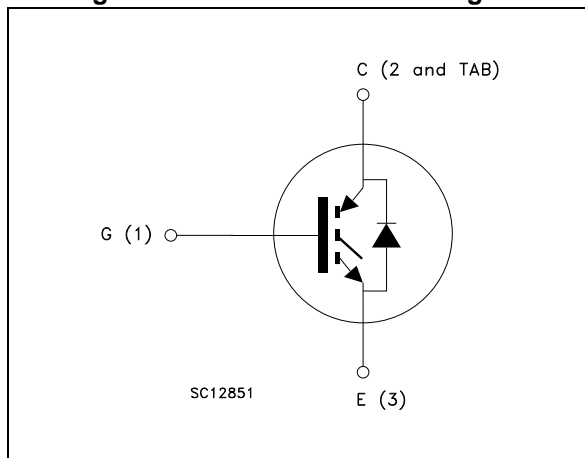

Figure 1. Internal schematic diagram



Features

- Designed for automotive applications and AEC-Q101 qualified
- Low on-voltage drop ($V_{CE(sat)}$)
- Low C_{res} / C_{ies} ratio (no cross conduction susceptibility)
- Switching losses include diode recovery energy
- Short-circuit rated
- Very soft Ultrafast recovery anti-parallel diode

Applications

- High frequency inverters
- SMPS and PFC in both hard switch and resonant topologies
- Motor drives
- Injection systems

Description

This device utilizes the advanced PowerMESH™ process for the IGBT and the Turbo 2 Ultrafast high voltage technology for the diode. The combination results in a very good trade-off between conduction losses and switching behavior rendering the product ideal for diverse high voltage applications operating at high frequencies.

Table 1. Device summary

Order code	Marking	Package	Packaging
STGD10HF60KD	GD10HF60KD	DPAK	Tape and reel

Contents

1	Electrical ratings	3
2	Electrical characteristics	4
2.1	Electrical characteristics (curves)	7
3	Test circuits	13
4	Package mechanical data	14
5	Packaging mechanical data	18
6	Revision history	20

1 Electrical ratings

$T_{CASE} = 25\text{ °C}$ unless otherwise specified.

Table 2. Absolute maximum ratings

Symbol	Parameter	Value	Unit
V_{CES}	Collector-emitter voltage ($V_{GE} = 0$)	600	V
$I_C^{(1)}$	Collector current (continuous) at $T_C = 25\text{ °C}$	18	A
$I_C^{(1)}$	Collector current (continuous) at $T_C = 100\text{ °C}$	10	A
$I_{CL}^{(2)}$	Turn-off latching current	30	A
$I_{CP}^{(3)}$	Pulsed collector current	30	A
V_{GE}	Gate-emitter voltage	± 20	V
V_{GEM}	Gate-emitter voltage pulsed ($t_p \leq 1\text{ ms}$)	± 30	V
I_F	Diode RMS forward current	7	A
I_{FSM}	Surge non repetitive forward current $t_p = 10\text{ ms}$ sinusoidal	20	A
P_{TOT}	Total dissipation	62.5	W
t_{scw}	Short circuit withstand time ($V_{CE} = 50\text{ V}$, $V_{GE} = 15\text{ V}$, $T_C = 150\text{ °C}$)	10	μs
T_j	IGBT operating junction temperature	- 55 to 150	$^{\circ}\text{C}$
	Diode operating junction temperature	- 55 to 175	$^{\circ}\text{C}$
T_{stg}	Storage temperature	- 65 to 150	$^{\circ}\text{C}$

1. Calculated according to the iterative formula:

$$I_C(T_C) = \frac{T_{j(max)} - T_C}{R_{thj-c} \times V_{CE(sat)(max)}(T_{j(max)}, I_C(T_C))}$$

2. $V_{clamp} = 80\%$ of V_{CES} , $T_j = 150\text{ °C}$, $R_G = 10\ \Omega$, $V_{GE} = 15\text{ V}$
3. Pulse width limited by max. junction temperature allowed

Table 3. Thermal data

Symbol	Parameter	Value	Unit
$R_{thj-case}$	Thermal resistance junction-case IGBT	2	$^{\circ}\text{C/W}$
$R_{thj-case}$	Thermal resistance junction-case diode	5.8	$^{\circ}\text{C/W}$
$R_{thj-amb}$	Thermal resistance junction-ambient	100	$^{\circ}\text{C/W}$

2 Electrical characteristics

T_{CASE}=25 °C unless otherwise specified.

Table 4. Static

Symbol	Parameter	Test conditions	Min.	Typ.	Max.	Unit
V _{(BR)CES}	Collector-emitter breakdown voltage (V _{GE} = 0)	I _C = 1 mA, T _C = -40 °C ⁽¹⁾		610		V
		I _C = 1 mA	600	650		V
		I _C = 1 mA, T _C = 150 °C		700		V
I _{GES}	Gate-emitter leakage current (V _{CE} = 0)	V _{GE} = ±20 V V _{GE} = ±20 V, T _C = 150 °C			±100 ± 1	nA µA
I _{CES}	Collector cut-off current (V _{GE} = 0)	V _{CE} = 600 V V _{CE} = 600 V, T _C = 150 °C			150 1	µA mA
V _{GE(th)}	Gate threshold voltage	V _{CE} = V _{GE} , I _C = 250 µA	4.5		6.5	V
V _{CE(sat)}	Collector-emitter saturation voltage	V _{GE} = 15 V, I _C = 5 A	1.4		2.5	V

1. Value guaranteed by design

Table 5. Dynamic ⁽¹⁾

Symbol	Parameter	Test conditions	Min.	Typ.	Max.	Unit
C _{ies}	Input capacitance	V _{CE} = 25 V, f = 1 MHz, V _{GE} = 0	-	430	-	pF
C _{oes}	Output capacitance		-	45	-	pF
C _{res}	Reverse transfer capacitance		-	10	-	pF
Q _g	Total gate charge	V _{CE} = 400 V, I _C = 5 A, V _{GE} = 15 V	-	23	-	nC
Q _{ge}	Gate-emitter charge		-	4	-	nC
Q _{gc}	Gate-collector charge		-	11	-	nC

1. Values guaranteed by design

Table 6. Switching on/off (inductive load) ⁽¹⁾

Symbol	Parameter	Test conditions	Min.	Typ.	Max.	Unit
$t_{d(on)}$	Turn-on delay time	$V_{CC} = 400\text{ V}, I_C = 5\text{ A}$ $R_G = 10\ \Omega, V_{GE} = 15\text{ V}$	-	9.5	-	ns
t_r	Current rise time		-	4.4	-	ns
$(di/dt)_{on}$	Turn-on current slope				930	
$t_{d(on)}$	Turn-on delay time	$V_{CC} = 400\text{ V}, I_C = 5\text{ A}$ $R_G = 10\ \Omega, V_{GE} = 15\text{ V}$ $T_C = 150\text{ }^\circ\text{C}$	-	11	-	ns
t_r	Current rise time		-	4.8	-	ns
$(di/dt)_{on}$	Turn-on current slope		-	904	-	A/ μ s
$t_{r(Voff)}$	Off voltage rise time	$V_{CC} = 400\text{ V}, I_C = 5\text{ A},$ $R_{GE} = 10\ \Omega, V_{GE} = 15\text{ V}$	-	34	-	ns
$t_{d(off)}$	Turn-off delay time		-	87	-	ns
t_f	Current fall time		-	100	-	ns
$t_{r(Voff)}$	Off voltage rise time	$V_{CC} = 400\text{ V}, I_C = 5\text{ A},$ $R_{GE} = 10\ \Omega, V_{GE} = 15\text{ V}$ $T_C = 150\text{ }^\circ\text{C}$	-	83	-	ns
$t_{d(off)}$	Turn-off delay time		-	93	-	ns
t_f	Current fall time		-	224	-	ns

1. Value guaranteed by design

Table 7. Switching energy (inductive load) ⁽¹⁾

Symbol	Parameter	Test conditions	Min	Typ.	Max	Unit
$E_{on}^{(2)}$	Turn-on switching losses	$V_{CC} = 400\text{ V}, I_C = 5\text{ A}$ $R_G = 10\ \Omega, V_{GE} = 15\text{ V}$	-	45	-	μ J
$E_{off}^{(3)}$	Turn-off switching losses		-	105	-	μ J
E_{ts}	Total switching losses		-	150	-	μ J
$E_{on}^{(2)}$	Turn-on switching losses	$V_{CC} = 400\text{ V}, I_C = 5\text{ A}$ $R_G = 10\ \Omega, V_{GE} = 15\text{ V}$ $T_C = 150\text{ }^\circ\text{C}$	-	84	-	μ J
$E_{off}^{(3)}$	Turn-off switching losses		-	286	-	μ J
E_{ts}	Total switching losses		-	370	-	μ J

- Value guaranteed by design
- IGBT and diode are at the same temperature
- Turn-off losses include also the tail of the collector current

Table 8. Collector-emitter diode

Symbol	Parameter	Test conditions	Min	Typ.	Max	Unit
V_F	Forward on-voltage	$I_F = 3 \text{ A}$	-	1.75	2.5	V
		$I_F = 3 \text{ A}, T_C = 150 \text{ }^\circ\text{C}$	-	1.45		V
$t_{rr}^{(1)}$	Reverse recovery time	$I_F = 3 \text{ A}, V_R = 400 \text{ V},$ $di/dt = 100 \text{ A}/\mu\text{s}$	-	50		ns
$Q_{rr}^{(1)}$	Reverse recovery charge		-	45		nC
$I_{rm}^{(1)}$	Reverse recovery current		-	1.7		A
$t_{rr}^{(1)}$	Reverse recovery time	$I_F = 3 \text{ A}, V_R = 400 \text{ V},$ $T_C = 150 \text{ }^\circ\text{C},$ $di/dt = 100 \text{ A}/\mu\text{s}$	-	100		ns
$Q_{rr}^{(1)}$	Reverse recovery charge		-	150		nC
$I_{rm}^{(1)}$	Reverse recovery current		-	3.1		A

1. Value guaranteed by design

2.1 Electrical characteristics (curves)

Figure 2. Output characteristics ($T_C = -50^\circ\text{C}$)

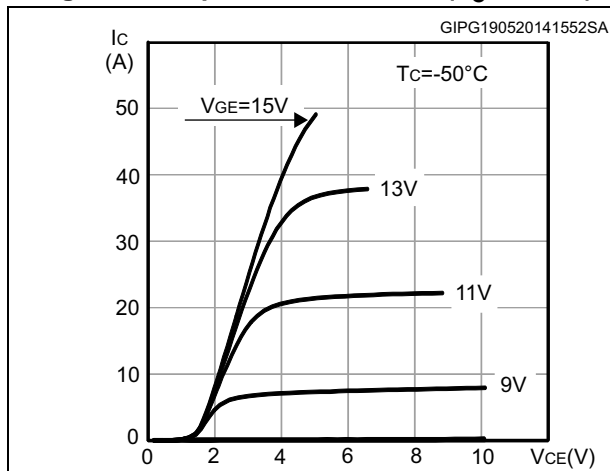

Figure 3. Output characteristics ($T_C = 25^\circ\text{C}$)

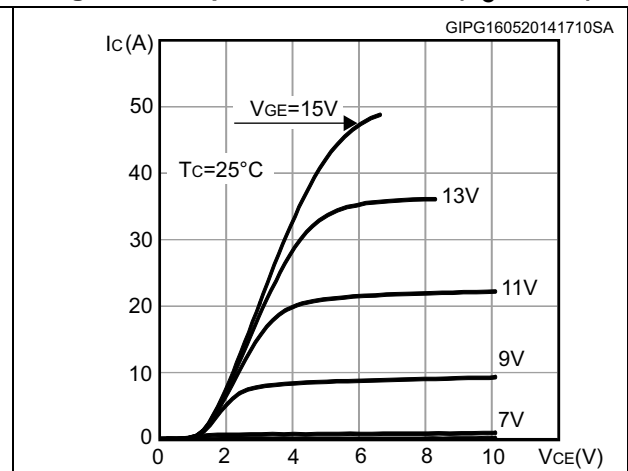

Figure 4. Output characteristics ($T_C = 150^\circ\text{C}$)

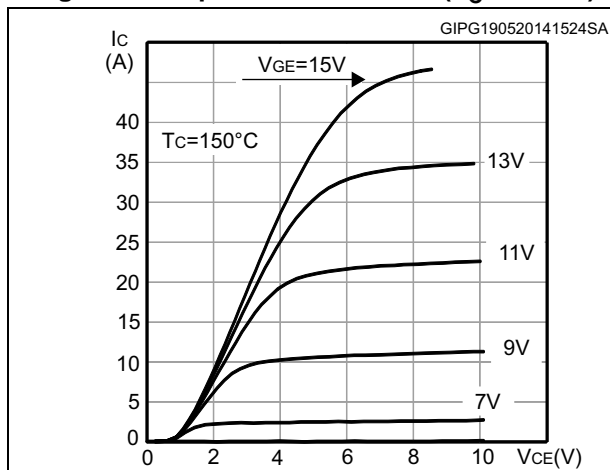

Figure 5. Transfer characteristics

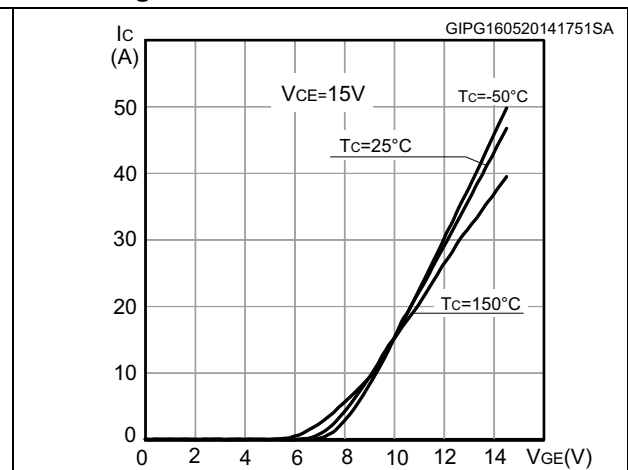

Figure 6. Collector-emitter on voltage vs. collector current

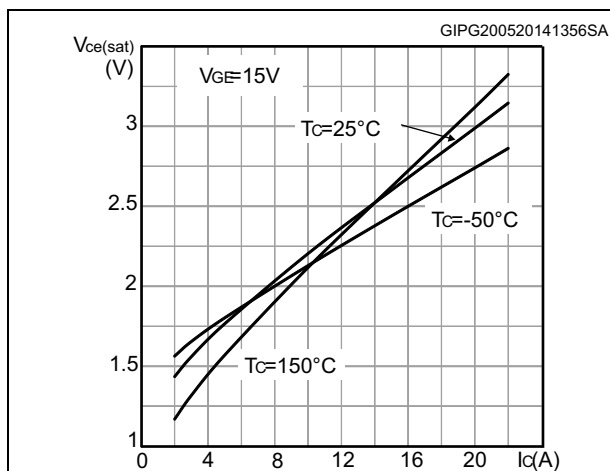

Figure 7. Collector-emitter on voltage vs. temperature

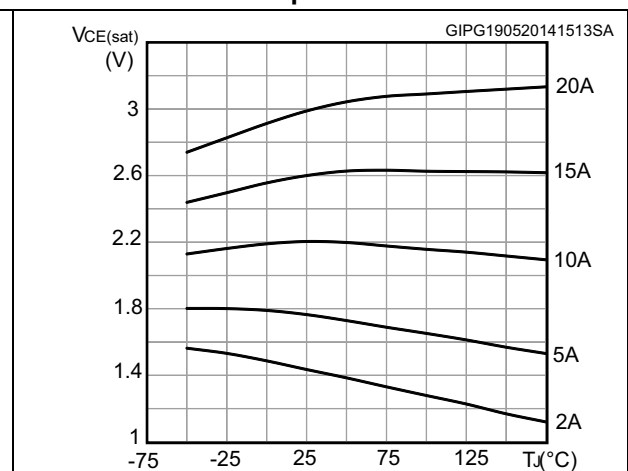

Figure 8. Normalized $V_{(BR)CES}$ vs. temperature

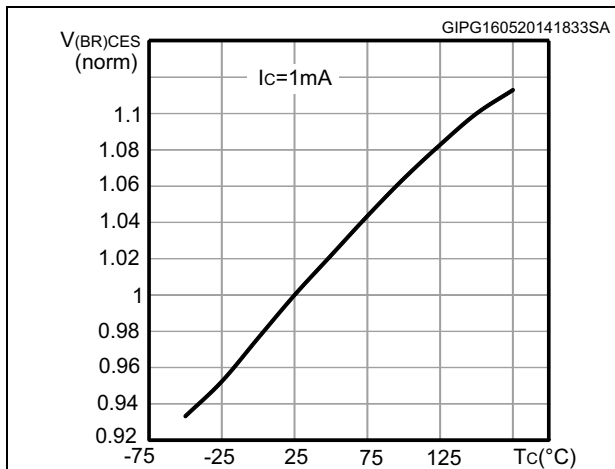

Figure 9. Normalized gate threshold vs. temperature

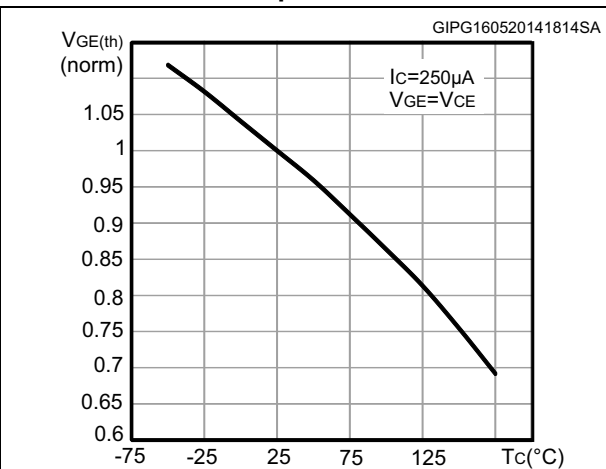

Figure 10. Gate charge vs. gate-emitter voltage

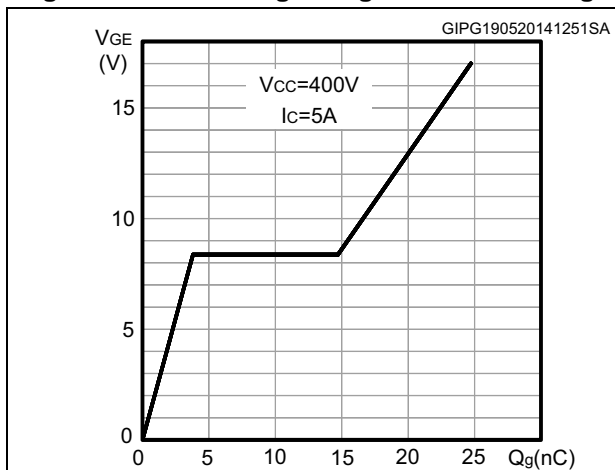

Figure 11. Capacitance variations

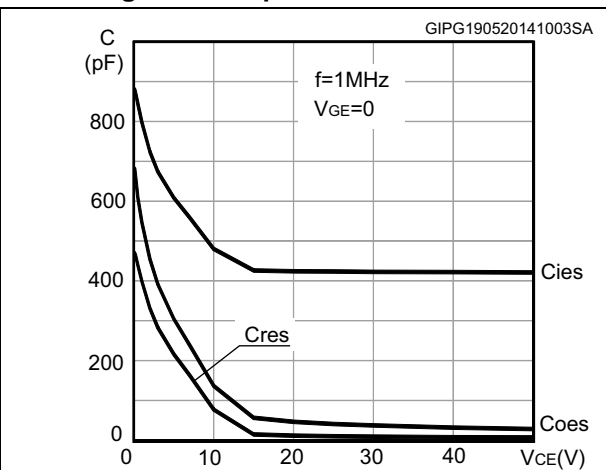

Figure 12. Switching losses vs. temperature

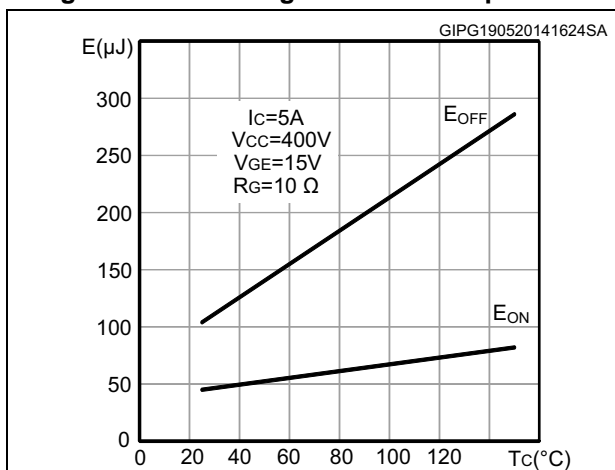

Figure 13. Switching losses vs. gate resistance

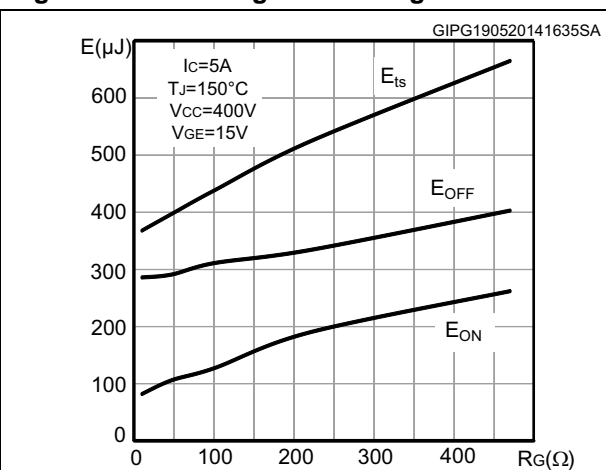

Figure 14. Switching losses vs. collector current

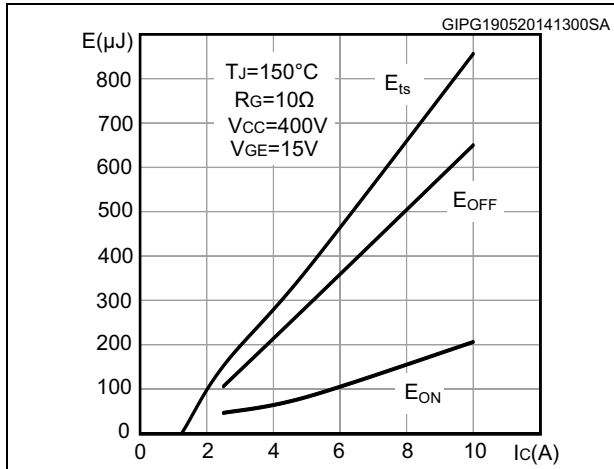

Figure 16. RBSOA

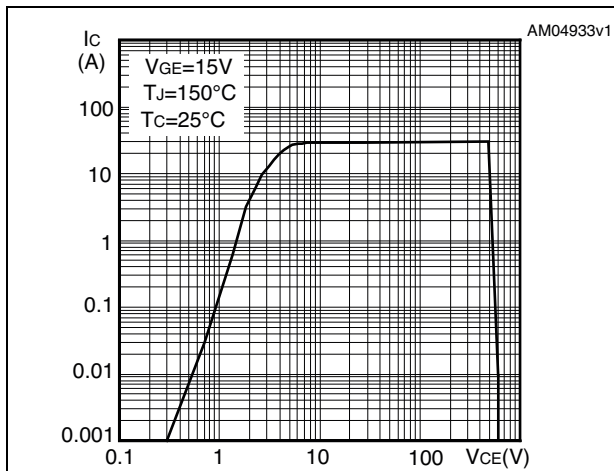

Figure 18. Switching times vs. gate resistance at Tj=150 °C

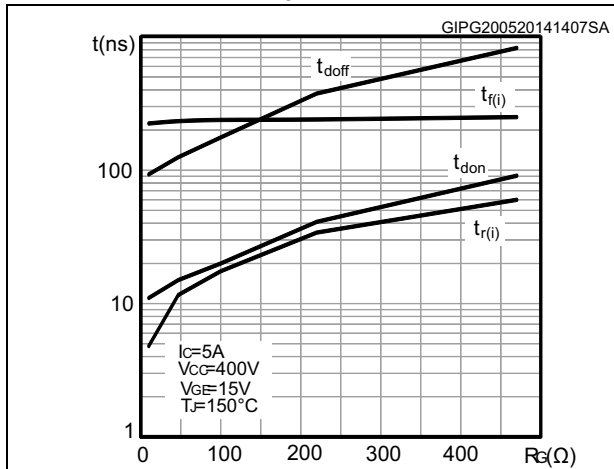

Figure 15. Short-circuit withstand time and current vs. gate-emitter voltage

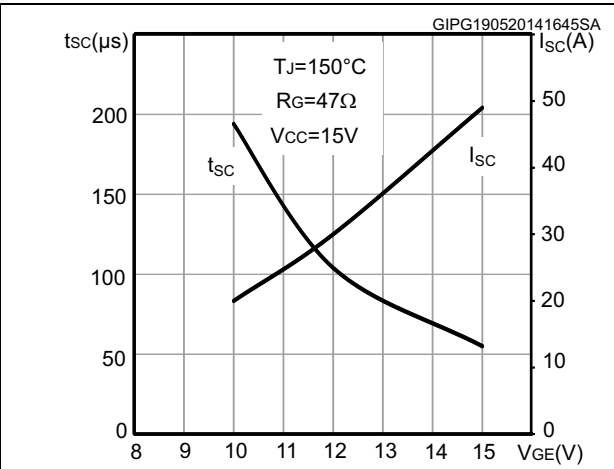

Figure 17. Switching times vs. gate resistance at Tj=25 °C

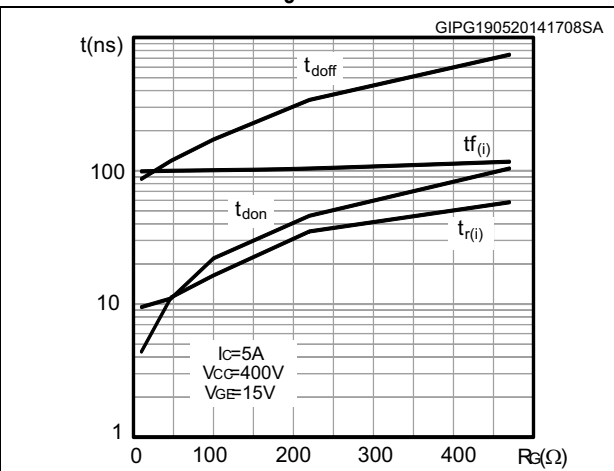

Figure 19. Switching times vs. collector current

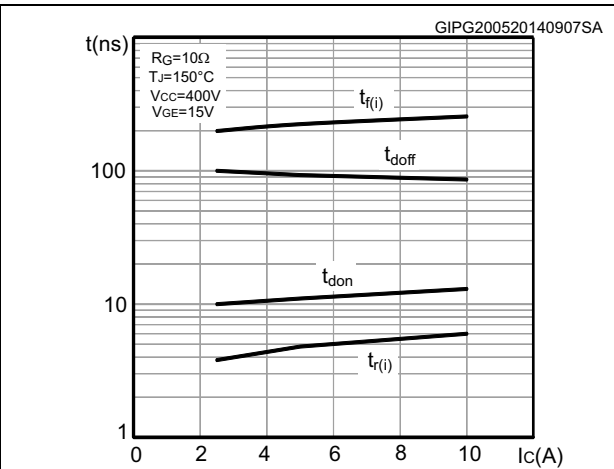

Figure 20. Diode forward voltage drop vs. forward current

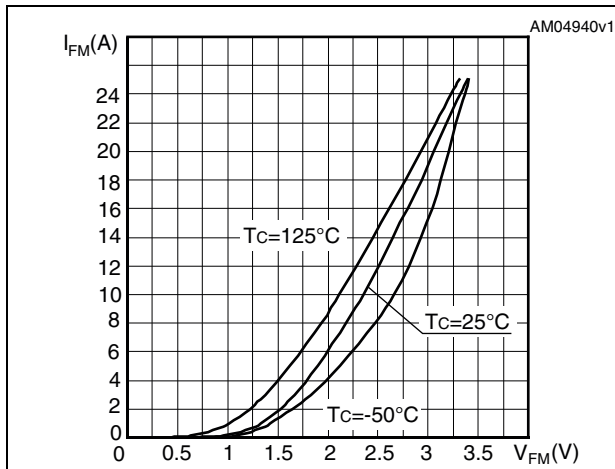

Figure 21. Peak reverse recovery current vs. di/dt

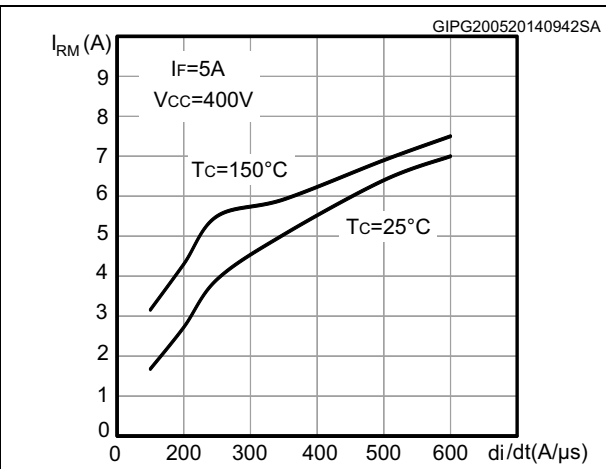

Figure 22. Reverse recovery time vs. di/dt

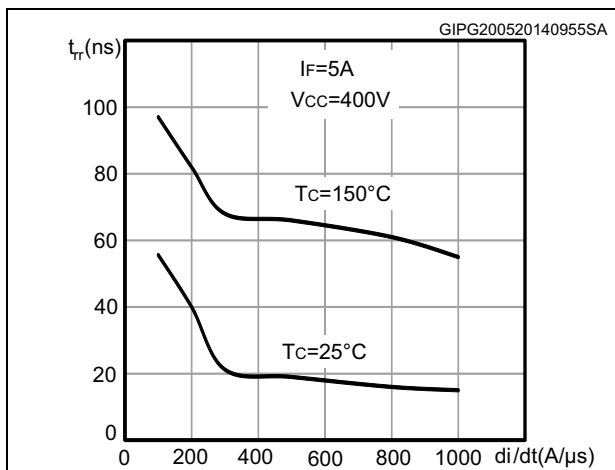

Figure 23. Reverse recovery softness factor vs. di/dt

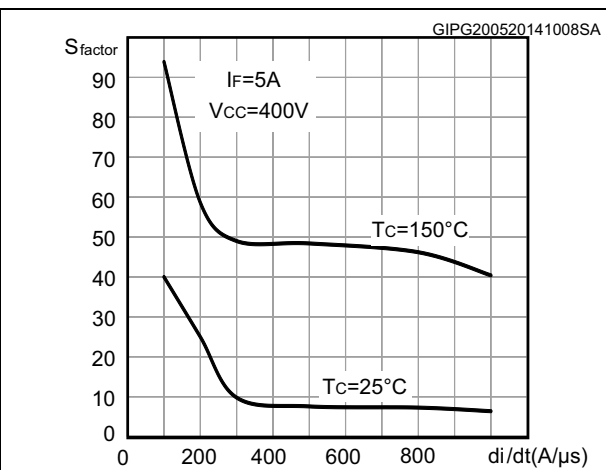

Figure 24. Reverse recovery charges vs. di/dt

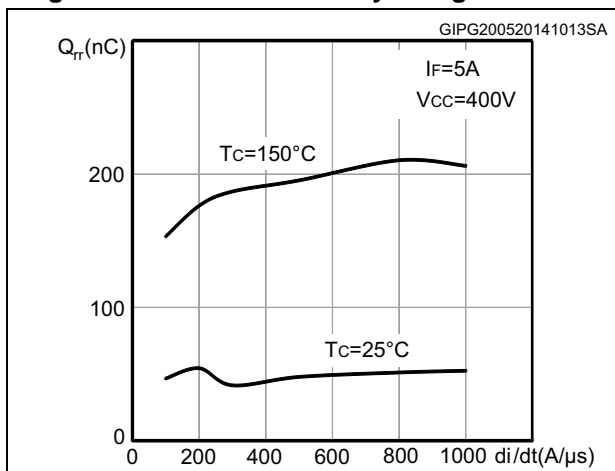

Figure 25. IGBT thermal impedance

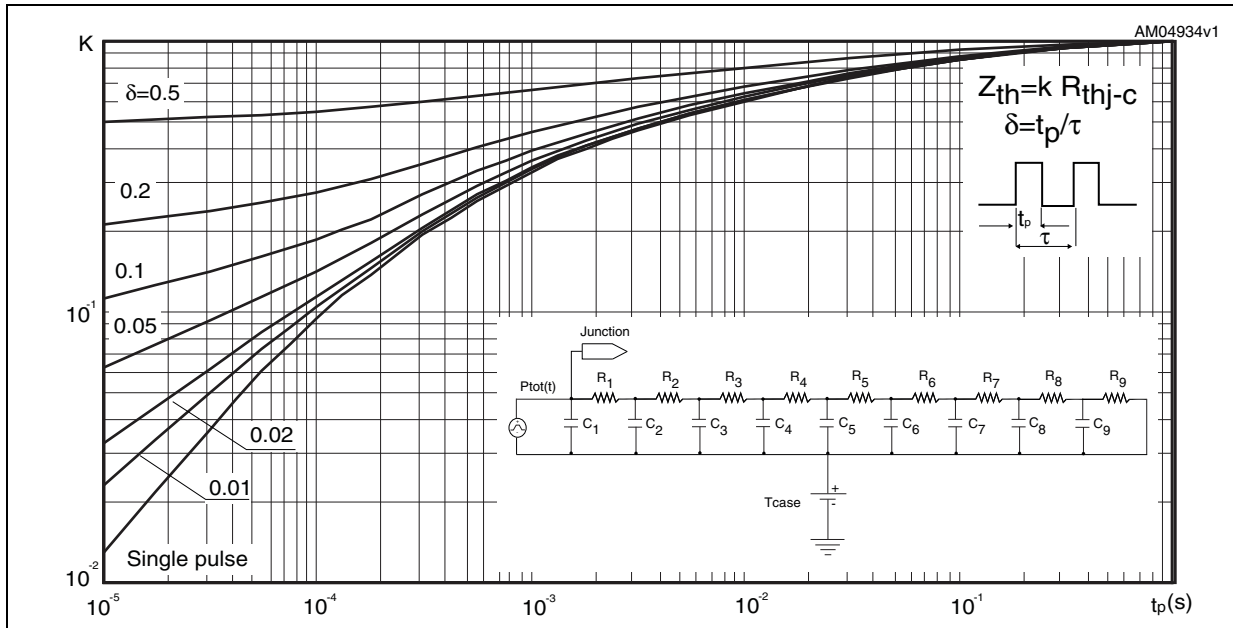

Table 9. IGBT RC-Cauer thermal network

Symbol	Value	Unit	Symbol	Value	Unit
\$R_1\$	0.344	\$^\circ\text{C}/\text{W}\$	\$C_1\$	0.4E-3	\$\text{W}^*\text{s}/^\circ\text{C}\$
\$R_2\$	0.0686	\$^\circ\text{C}/\text{W}\$	\$C_2\$	0.162E-4	\$\text{W}^*\text{s}/^\circ\text{C}\$
\$R_3\$	0.0958	\$^\circ\text{C}/\text{W}\$	\$C_3\$	0.684E-3	\$\text{W}^*\text{s}/^\circ\text{C}\$
\$R_4\$	0.177	\$^\circ\text{C}/\text{W}\$	\$C_4\$	0.923E-4	\$\text{W}^*\text{s}/^\circ\text{C}\$
\$R_5\$	0.250	\$^\circ\text{C}/\text{W}\$	\$C_5\$	0.3E-2	\$\text{W}^*\text{s}/^\circ\text{C}\$
\$R_6\$	0.245	\$^\circ\text{C}/\text{W}\$	\$C_6\$	0.9E-2	\$\text{W}^*\text{s}/^\circ\text{C}\$
\$R_7\$	0.152	\$^\circ\text{C}/\text{W}\$	\$C_7\$	0.678E-3	\$\text{W}^*\text{s}/^\circ\text{C}\$
\$R_8\$	0.135	\$^\circ\text{C}/\text{W}\$	\$C_8\$	0.807E-3	\$\text{W}^*\text{s}/^\circ\text{C}\$
\$R_9\$	0.530	\$^\circ\text{C}/\text{W}\$	\$C_9\$	0.248	\$\text{W}^*\text{s}/^\circ\text{C}\$

Figure 26. Diode thermal impedance

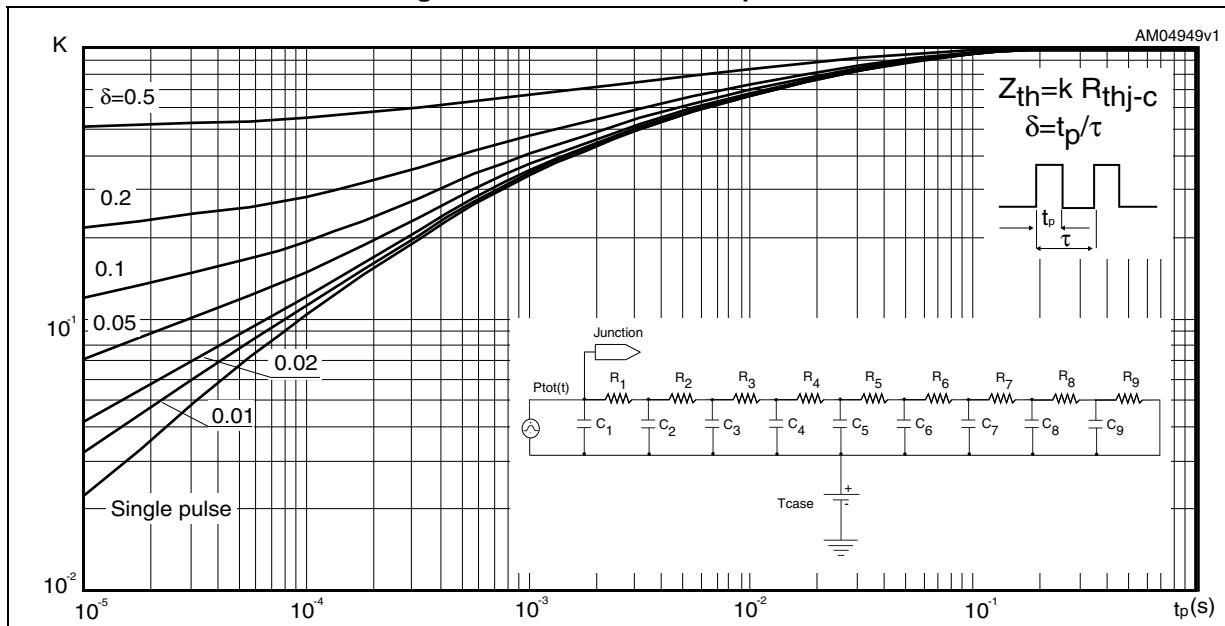
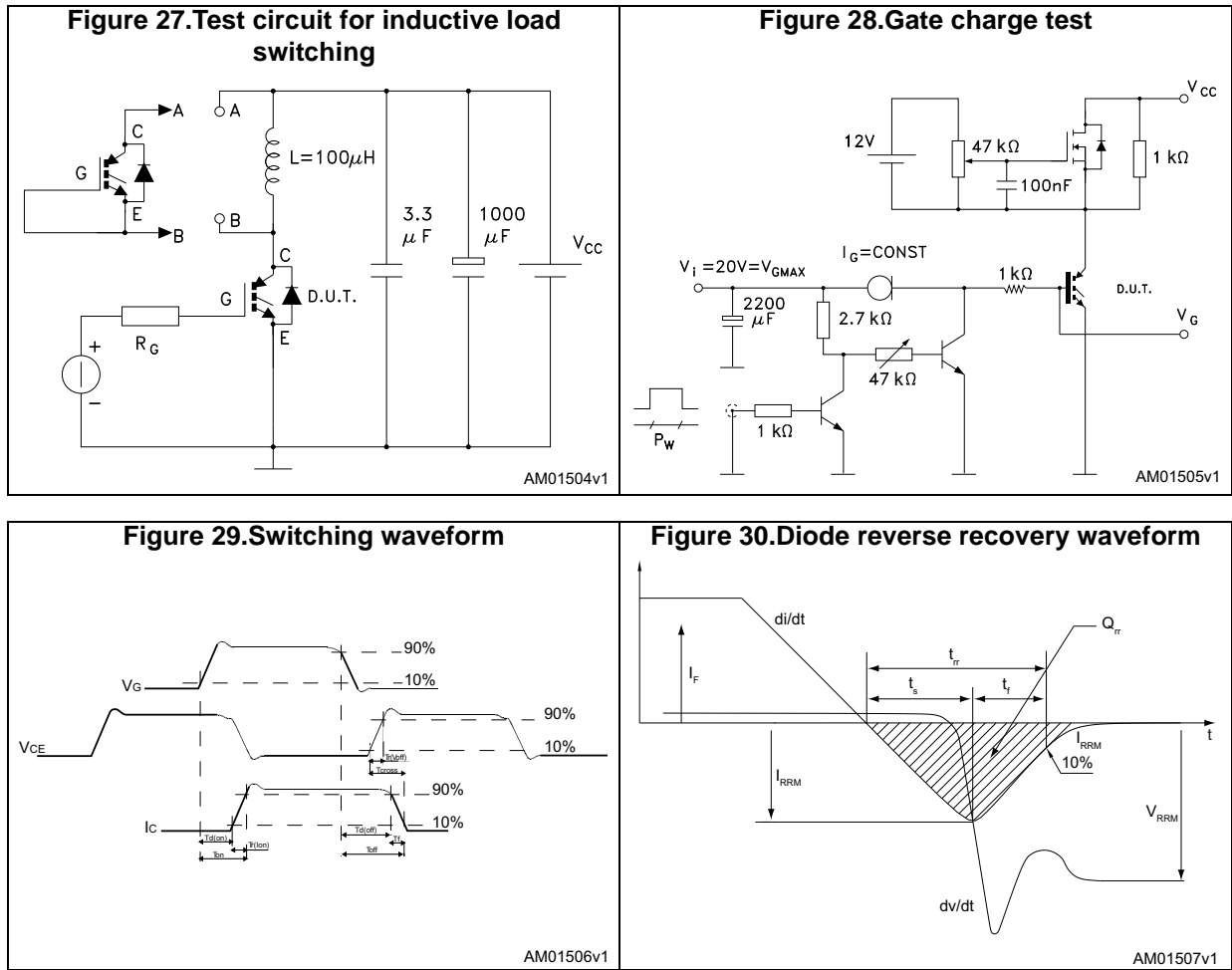

Table 10. Diode RC-Cauer thermal network

Symbol	Value	Unit	Symbol	Value	Unit
R ₁	0.478	°C/W	C ₁	0.8E-4	W*s/°C
R ₂	0.542	°C/W	C ₂	1E-4	W*s/°C
R ₃	0.600	°C/W	C ₃	2E-4	W*s/°C
R ₄	0.277	°C/W	C ₄	0.5E-5	W*s/°C
R ₅	0.844	°C/W	C ₅	0.145E-2	W*s/°C
R ₆	0.313	°C/W	C ₆	0.499E-4	W*s/°C
R ₇	0.108	°C/W	C ₇	0.727E-3	W*s/°C
R ₈	0.891	°C/W	C ₈	0.393E-4	W*s/°C
R ₉	1.73	°C/W	C ₉	0.0176	W*s/°C

3 Test circuits



4 Package mechanical data

In order to meet environmental requirements, ST offers these devices in different grades of ECOPACK[®] packages, depending on their level of environmental compliance. ECOPACK[®] specifications, grade definitions and product status are available at: www.st.com. ECOPACK[®] is an ST trademark.

Figure 31. DPAK (TO-252) type A outline

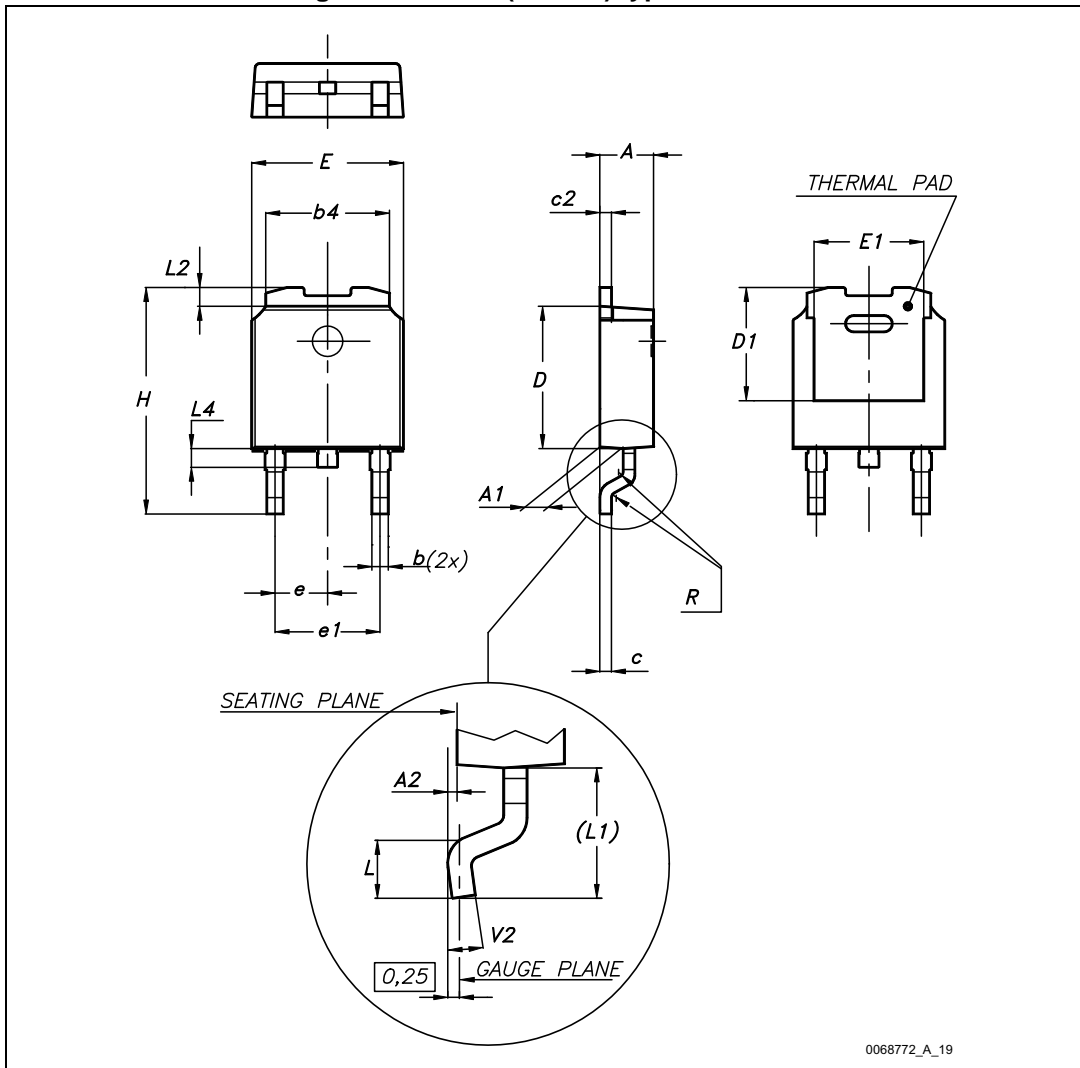

0068772_A_19

Table 11. DPAK (TO-252) type A mechanical data

Dim.	mm		
	Min.	Typ.	Max.
A	2.20		2.40
A1	0.90		1.10
A2	0.03		0.23
b	0.64		0.90
b4	5.20		5.40
c	0.45		0.60
c2	0.48		0.60
D	6.00		6.20
D1	4.95	5.10	5.25
E	6.40		6.60
E1	4.60	4.70	4.80
e	2.16	2.28	2.40
e1	4.40		4.60
H	9.35		10.10
L	1.00		1.50
(L1)	2.60	2.80	3.00
L2	0.65	0.80	0.95
L4	0.60		1.00
R		0.20	
V2	0°		8°

Figure 32. DPAK (TO-252) footprint (a)

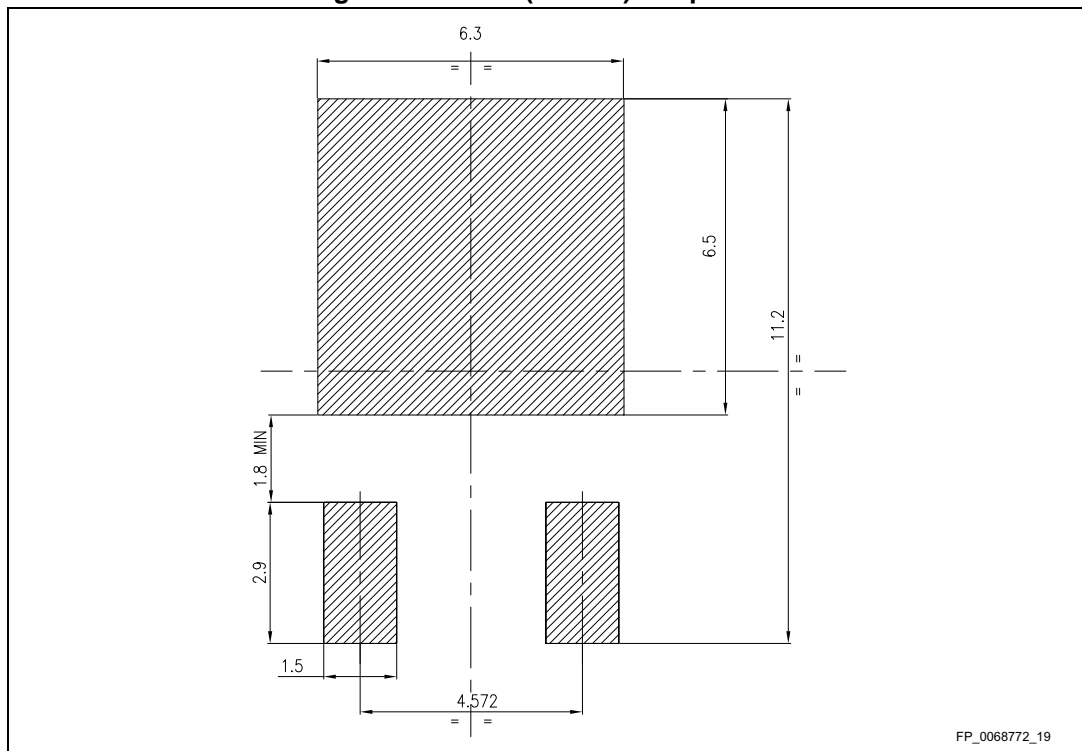

a. All dimensions are in millimeters

5 Packaging mechanical data

Figure 33. Tape for DPAK (TO-252)

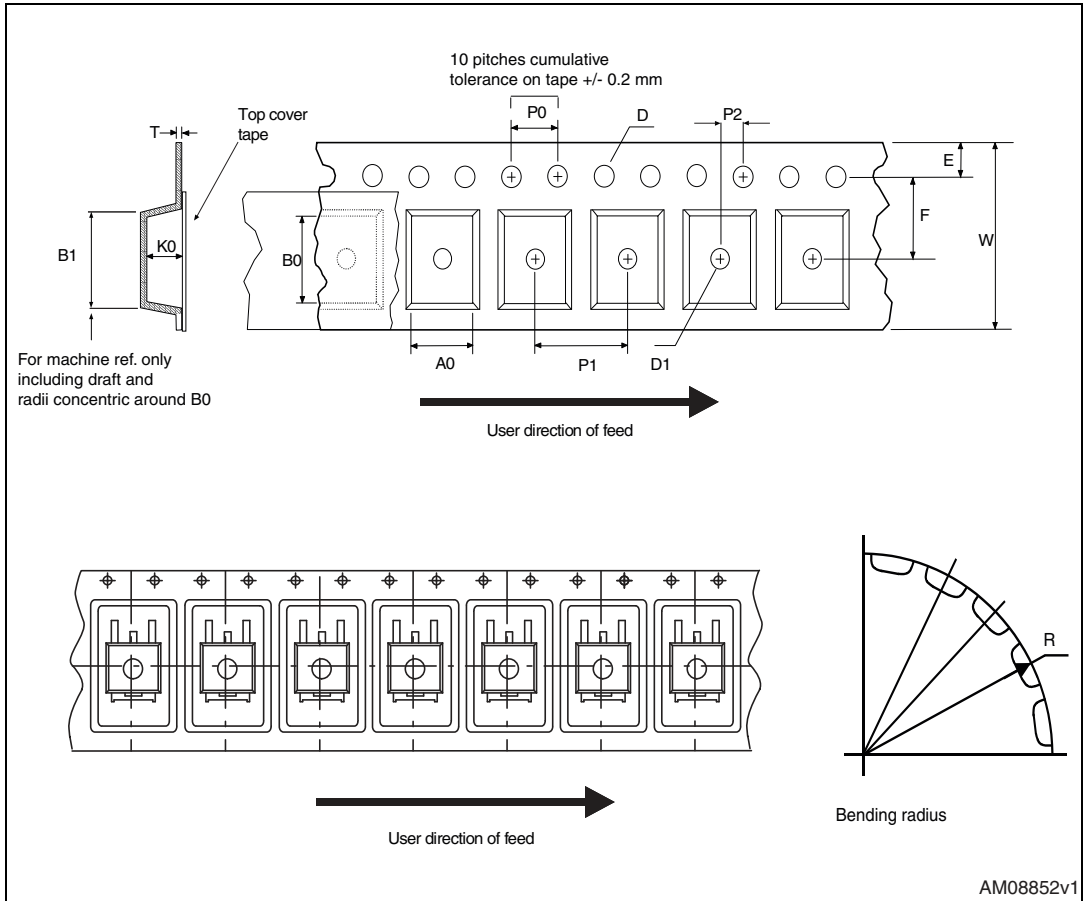

Figure 34. Reel for DPAK (TO-252)

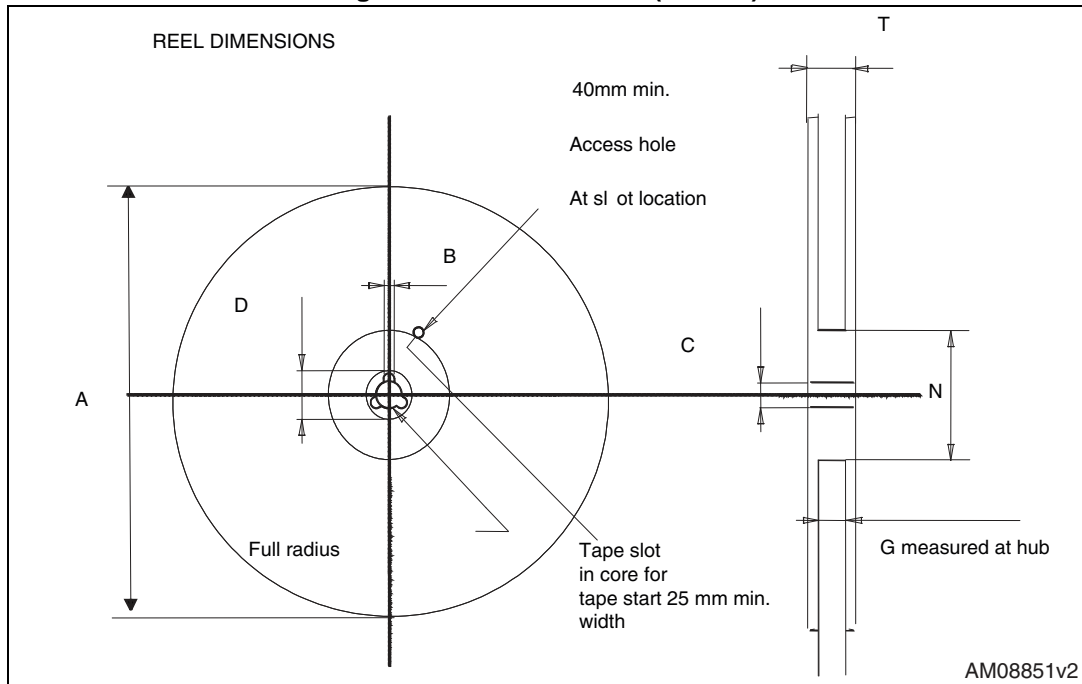

Table 12. DPAK (TO-252) tape and reel mechanical data

Tape			Reel		
Dim.	mm		Dim.	mm	
	Min.	Max.		Min.	Max.
A0	6.8	7	A		330
B0	10.4	10.6	B	1.5	
B1		12.1	C	12.8	13.2
D	1.5	1.6	D	20.2	
D1	1.5		G	16.4	18.4
E	1.65	1.85	N	50	
F	7.4	7.6	T		22.4
K0	2.55	2.75			
P0	3.9	4.1		Base qty.	2500
P1	7.9	8.1		Bulk qty.	2500
P2	1.9	2.1			
R	40				
T	0.25	0.35			
W	15.7	16.3			

6 Revision history

Table 13. Document revision history

Date	Revision	Changes
28-Feb-2012	1	First release
27-May-2014	2	<ul style="list-style-type: none">– Added: electrical characteristics (curves) section– Updated: package mechanical data section– Minor text changes
15-Sep-2015	3	<ul style="list-style-type: none">– Modified: $V_{CE(sat)}$ (min and max) values in static table– Modified: note 1 relative to collector-emitter diode table– Modified: collector-emitter on voltage vs. collector current figure and collector-emitter on voltage vs. temperature– Updated: test circuits section– Updated: Package mechanical data section– Minor text changes

IMPORTANT NOTICE – PLEASE READ CAREFULLY

STMicroelectronics NV and its subsidiaries ("ST") reserve the right to make changes, corrections, enhancements, modifications, and improvements to ST products and/or to this document at any time without notice. Purchasers should obtain the latest relevant information on ST products before placing orders. ST products are sold pursuant to ST's terms and conditions of sale in place at the time of order acknowledgement.

Purchasers are solely responsible for the choice, selection, and use of ST products and ST assumes no liability for application assistance or the design of Purchasers' products.

No license, express or implied, to any intellectual property right is granted by ST herein.

Resale of ST products with provisions different from the information set forth herein shall void any warranty granted by ST for such product.

ST and the ST logo are trademarks of ST. All other product or service names are the property of their respective owners.

Information in this document supersedes and replaces information previously supplied in any prior versions of this document.

© 2015 STMicroelectronics – All rights reserved