

# IRF7103QPbF

HEXFET® Power MOSFET

## Benefits

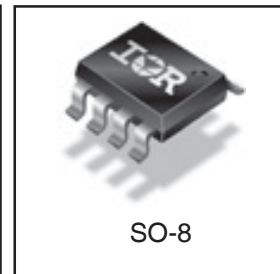
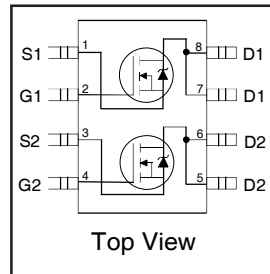
- Advanced Process Technology
- Dual N-Channel MOSFET
- Ultra Low On-Resistance
- 175°C Operating Temperature
- Repetitive Avalanche Allowed up to Tjmax
- Lead-Free

## Description

This HEXFET® Power MOSFET's in a Dual SO-8 package utilize the latest processing techniques to achieve extremely low on-resistance per silicon area. Additional features of these HEXFET Power MOSFET's are a 175°C junction operating temperature, fast switching speed and improved repetitive avalanche rating. These benefits combine to make this design an extremely efficient and reliable device for use in a wide variety of applications.

The efficient SO-8 package provides enhanced thermal characteristics and dual MOSFET die capability making it ideal in a variety of power applications. This dual, surface mount SO-8 can dramatically reduce board space and is also available in Tape & Reel.

| V <sub>DSS</sub> | R <sub>DS(on)</sub> max (mΩ) | I <sub>D</sub> |
|------------------|------------------------------|----------------|
| 50V              | 130 @ V <sub>GS</sub> = 10V  | 3.0A           |
|                  | 200 @ V <sub>GS</sub> = 4.5V | 1.5A           |



## Absolute Maximum Ratings

|  | Parameter  | Max.                      | Units |
|--|--|---------------------------|-------|
| I <sub>D</sub> @ T <sub>A</sub> = 25°C | Continuous Drain Current, V <sub>GS</sub> @ 4.5V | 3.0                       | A     |
| I <sub>D</sub> @ T <sub>A</sub> = 70°C | Continuous Drain Current, V <sub>GS</sub> @ 4.5V | 2.5                       |       |
| I <sub>DM</sub>                        | Pulsed Drain Current ①                           | 25                        |       |
| P <sub>D</sub> @ T <sub>A</sub> = 25°C | Power Dissipation ②                              | 2.4                       | W     |
|  | Linear Derating Factor                           | 16                        | W/°C  |
| V <sub>GS</sub>                        | Gate-to-Source Voltage                           | ± 20                      | V     |
| E <sub>AS</sub>                        | Single Pulse Avalanche Energy ④                  | 22                        | mJ    |
| I <sub>AR</sub>                        | Avalanche Current ①                              | See Fig. 16c, 16d, 19, 20 | A     |
| E <sub>AR</sub>                        | Repetitive Avalanche Energy ⑥                    |                           | mJ    |
| dv/dt                                  | Peak Diode Recovery dv/dt ⑤                      | 12                        | V/ns  |
| T <sub>J</sub>                         | Operating Junction and                           | -55 to + 175              | °C    |
| T <sub>STG</sub>                       | Storage Temperature Range                        |                           |       |

## Thermal Resistance

|                  | Parameter              | Typ. | Max. | Units |
|------------------|------------------------|------|------|-------|
| R <sub>θJL</sub> | Junction-to-Drain Lead | —    | 20   | °C/W  |
| R <sub>θJA</sub> | Junction-to-Ambient ④⑤ | —    | 62.5 |       |

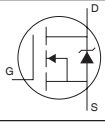
# IRF7103QPbF

International  
**IR** Rectifier

## Electrical Characteristics @ $T_J = 25^\circ\text{C}$ (unless otherwise specified)

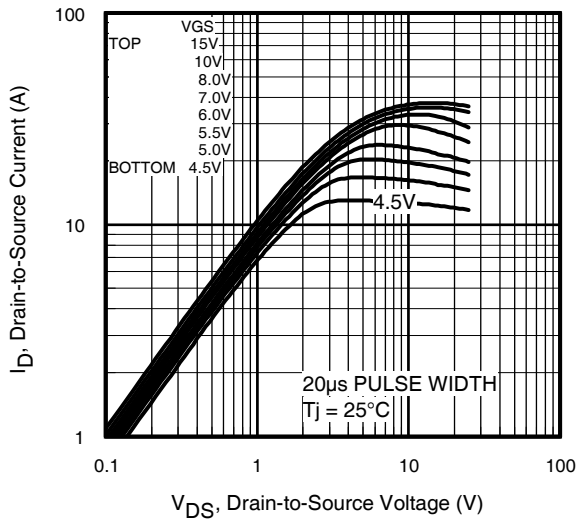
|                                 | Parameter                            | Min. | Typ.  | Max. | Units      | Conditions  |
|---------------------------------|--------------------------------------|------|-------|------|------------|---|
| $V_{(BR)DSS}$                   | Drain-to-Source Breakdown Voltage    | 50   | —     | —    | V          | $V_{GS} = 0V, I_D = 250\mu A$                       |
| $\Delta V_{(BR)DSS}/\Delta T_J$ | Breakdown Voltage Temp. Coefficient  | —    | 0.057 | —    | V/°C       | Reference to $25^\circ\text{C}, I_D = 1\text{mA}$   |
| $R_{DS(on)}$                    | Static Drain-to-Source On-Resistance | —    | —     | 130  | m $\Omega$ | $V_{GS} = 10V, I_D = 3.0A$ ②                        |
|                                 |                                      | —    | —     | 200  |            | $V_{GS} = 4.5V, I_D = 1.5A$ ②                       |
| $V_{GS(th)}$                    | Gate Threshold Voltage               | 1.0  | —     | 3.0  | V          | $V_{DS} = V_{GS}, I_D = 250\mu A$                   |
| $g_{fs}$                        | Forward Transconductance             | 3.4  | —     | —    | S          | $V_{DS} = 15V, I_D = 3.0A$                          |
| $I_{DSS}$                       | Drain-to-Source Leakage Current      | —    | —     | 2.0  | $\mu A$    | $V_{DS} = 40V, V_{GS} = 0V$                         |
|                                 |                                      | —    | —     | 25   |            | $V_{DS} = 40V, V_{GS} = 0V, T_J = 55^\circ\text{C}$ |
| $I_{GSS}$                       | Gate-to-Source Forward Leakage       | —    | —     | 100  | nA         | $V_{GS} = 20V$                                      |
|                                 | Gate-to-Source Reverse Leakage       | —    | —     | -100 |            | $V_{GS} = -20V$                                     |
| $Q_g$                           | Total Gate Charge                    | —    | 10    | 15   | nC         | $I_D = 2.0A$  |
| $Q_{gs}$                        | Gate-to-Source Charge                | —    | 1.2   | —    |            | $V_{DS} = 40V$                                      |
| $Q_{gd}$                        | Gate-to-Drain ("Miller") Charge      | —    | 2.8   | —    |            | $V_{GS} = 10V$                                      |
| $t_{d(on)}$                     | Turn-On Delay Time                   | —    | 5.1   | —    | ns         | $V_{DD} = 25V$ ②                                    |
| $t_r$                           | Rise Time                            | —    | 1.7   | —    |            | $I_D = 1.0A$  |
| $t_{d(off)}$                    | Turn-Off Delay Time                  | —    | 15    | —    |            | $R_G = 6.0\Omega$                                   |
| $t_f$                           | Fall Time                            | —    | 2.3   | —    |            | $R_D = 25\Omega$                                    |
| $C_{iss}$                       | Input Capacitance                    | —    | 255   | —    | pF         | $V_{GS} = 0V$                                       |
| $C_{oss}$                       | Output Capacitance                   | —    | 69    | —    |            | $V_{DS} = 25V$                                      |
| $C_{rss}$                       | Reverse Transfer Capacitance         | —    | 29    | —    |            | $f = 1.0\text{MHz}$                                 |

## Source-Drain Ratings and Characteristics

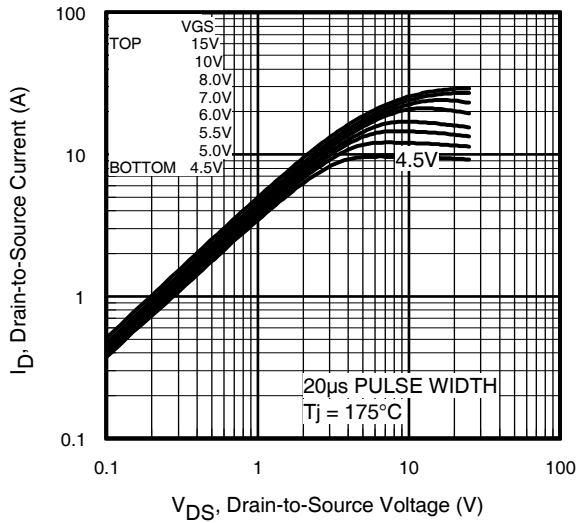
|          | Parameter                              | Min. | Typ. | Max. | Units | Conditions   |
|----------|--|------|------|------|-------|--|
| $I_S$    | Continuous Source Current (Body Diode) | —    | —    | 3.0  | A     | MOSFET symbol showing the integral reverse p-n junction diode.  |
| $I_{SM}$ | Pulsed Source Current (Body Diode) ①   | —    | —    | 12   |       |  |
| $V_{SD}$ | Diode Forward Voltage                  | —    | —    | 1.2  | V     | $T_J = 25^\circ\text{C}, I_S = 1.5A, V_{GS} = 0V$ ②  |
| $t_{rr}$ | Reverse Recovery Time                  | —    | 35   | 53   | ns    | $T_J = 25^\circ\text{C}, I_F = 1.5A$   |
| $Q_{rr}$ | Reverse Recovery Charge                | —    | 45   | 67   | nC    | $di/dt = 100A/\mu s$ ②   |

### Notes:

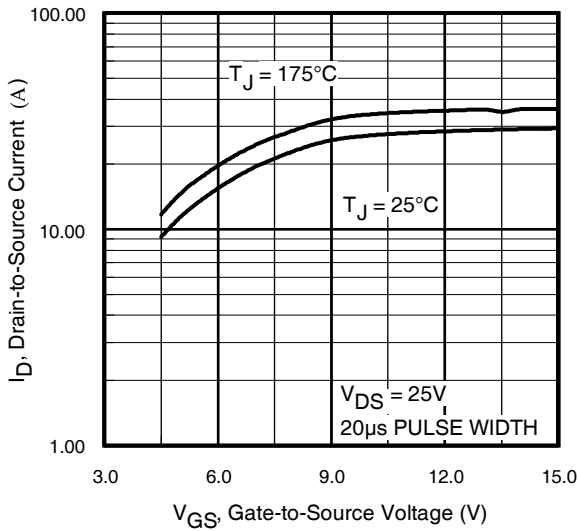
- ① Repetitive rating; pulse width limited by max. junction temperature.
- ② Pulse width  $\leq 400\mu s$ ; duty cycle  $\leq 2\%$ .
- ③ Surface mounted on 1 in square Cu board
- ④ Starting  $T_J = 25^\circ\text{C}, L = 4.9\text{mH}$   
 $R_G = 25\Omega, I_{AS} = 3.0A$ . (See Figure 12).
- ⑤  $I_{SD} \leq 2.0A, di/dt \leq 155A/\mu s, V_{DD} \leq V_{(BR)DSS}, T_J \leq 175^\circ\text{C}$
- ⑥ Limited by  $T_{Jmax}$ , see Fig.16c, 16d, 19, 20 for typical repetitive avalanche performance.



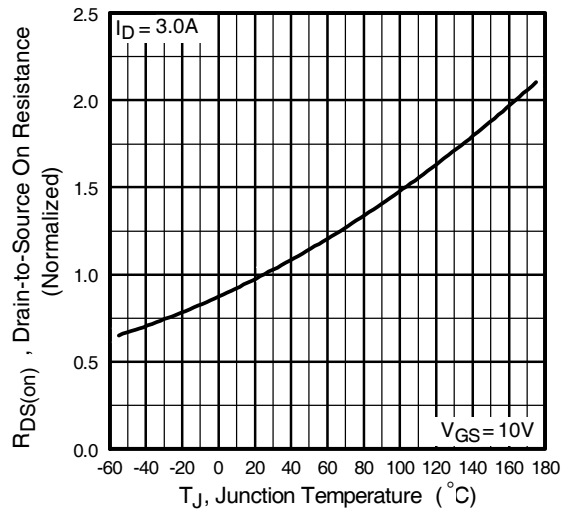
**Fig 1.** Typical Output Characteristics



**Fig 2.** Typical Output Characteristics

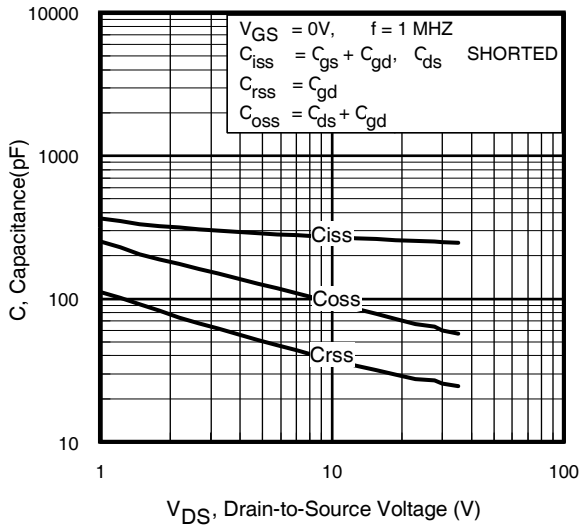


**Fig 3.** Typical Transfer Characteristics

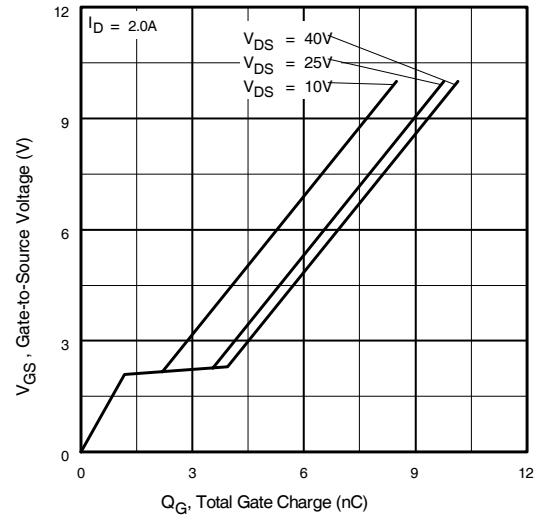


**Fig 4.** Normalized On-Resistance Vs. Temperature

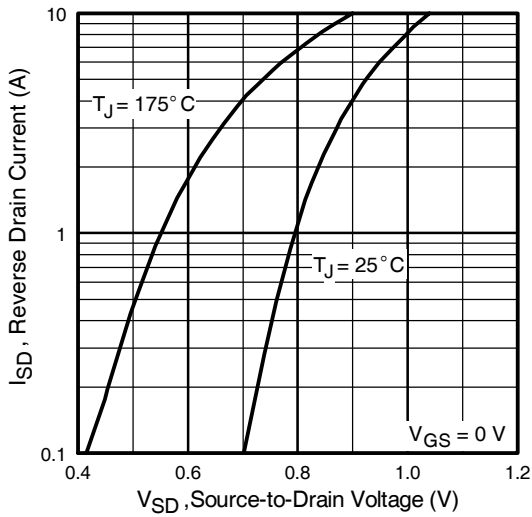
# IRF7103QPbF



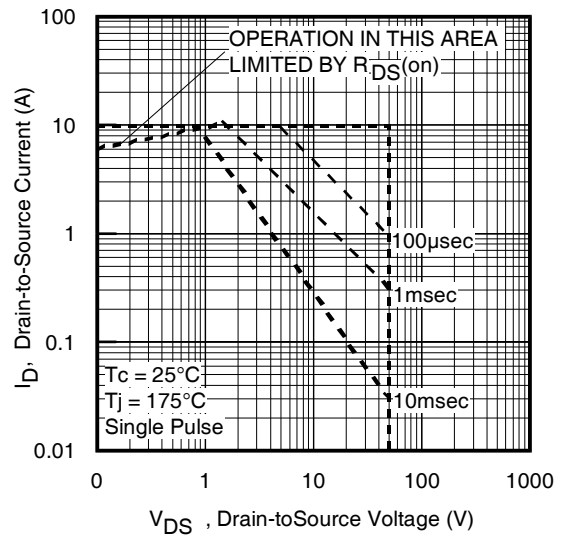
**Fig 5.** Typical Capacitance Vs. Drain-to-Source Voltage



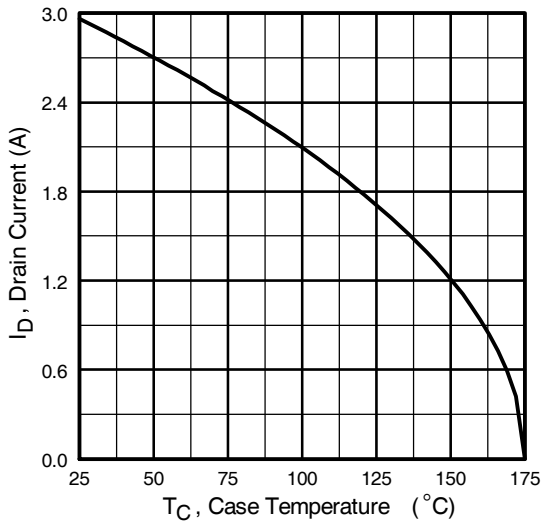
**Fig 6.** Typical Gate Charge Vs. Gate-to-Source Voltage



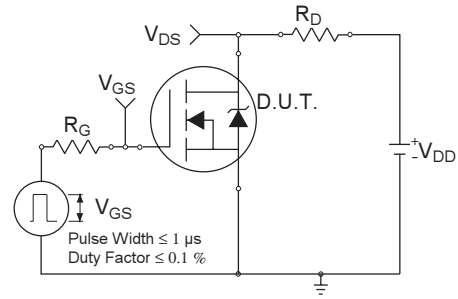
**Fig 7.** Typical Source-Drain Diode Forward Voltage



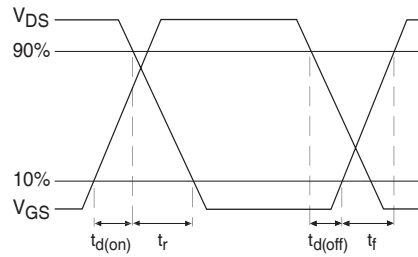
**Fig 8.** Maximum Safe Operating Area



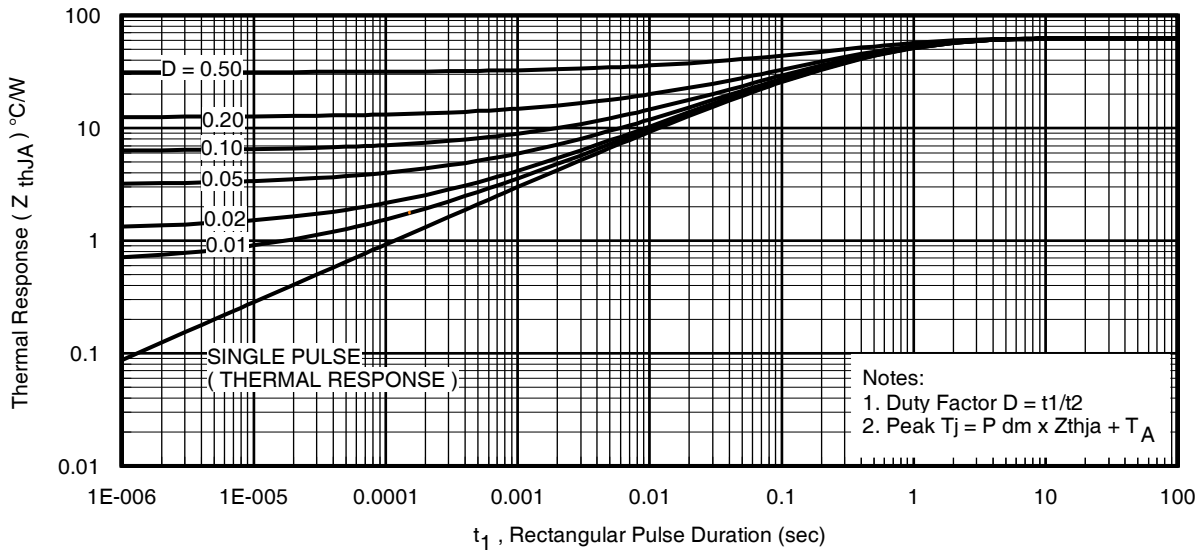
**Fig 9.** Maximum Drain Current Vs. Case Temperature



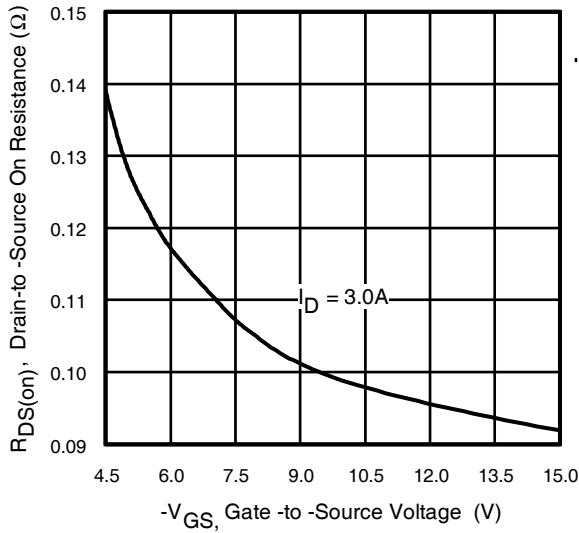
**Fig 10a.** Switching Time Test Circuit



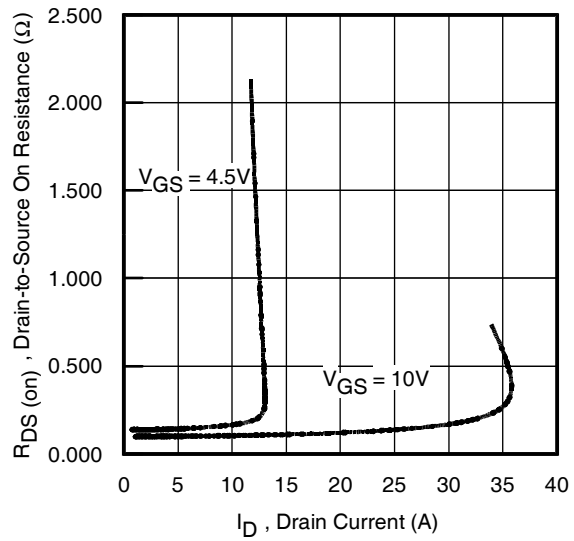
**Fig 10b.** Switching Time Waveforms



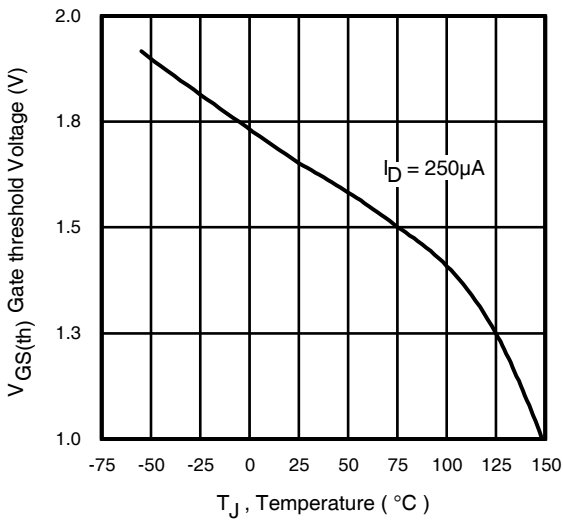
**Fig 11.** Typical Effective Transient Thermal Impedance, Junction-to-Ambient



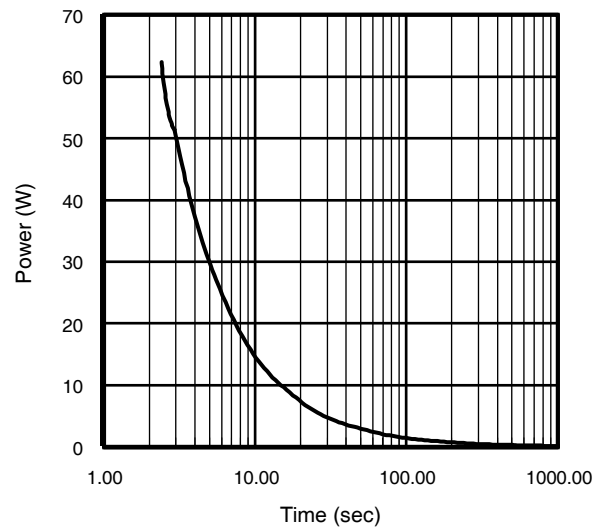
**Fig 12.** Typical On-Resistance Vs. Gate Voltage



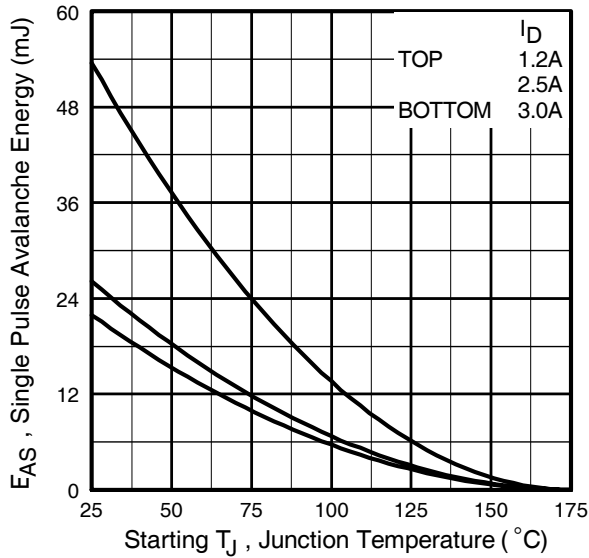
**Fig 13.** Typical On-Resistance Vs. Drain Current



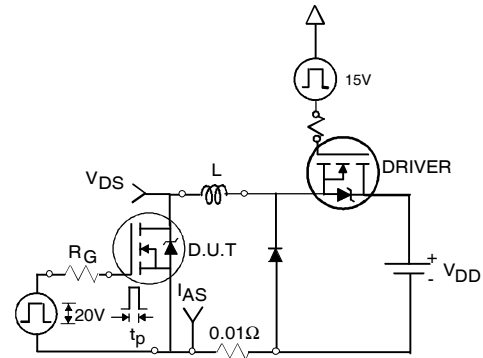
**Fig 14.** Typical Threshold Voltage Vs. Junction Temperature



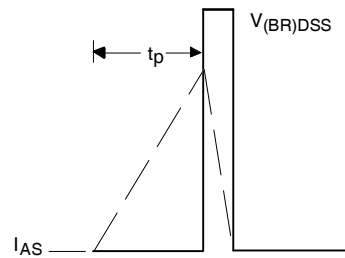
**Fig 15.** Typical Power Vs. Time



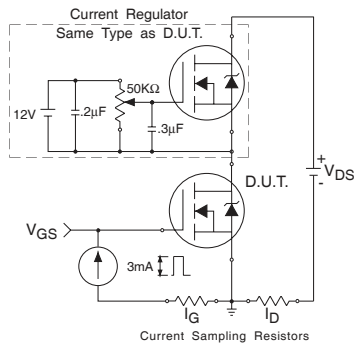
**Fig 16a.** Maximum Avalanche Energy Vs. Drain Current



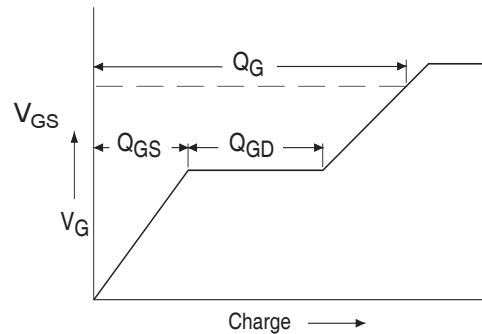
**Fig 16c.** Unclamped Inductive Test Circuit



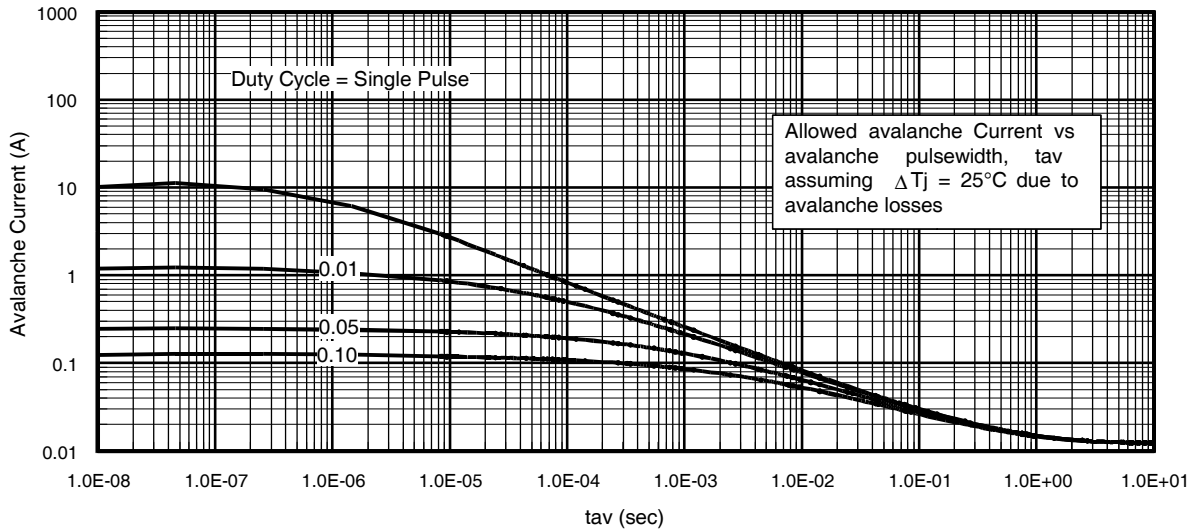
**Fig 16d.** Unclamped Inductive Waveforms



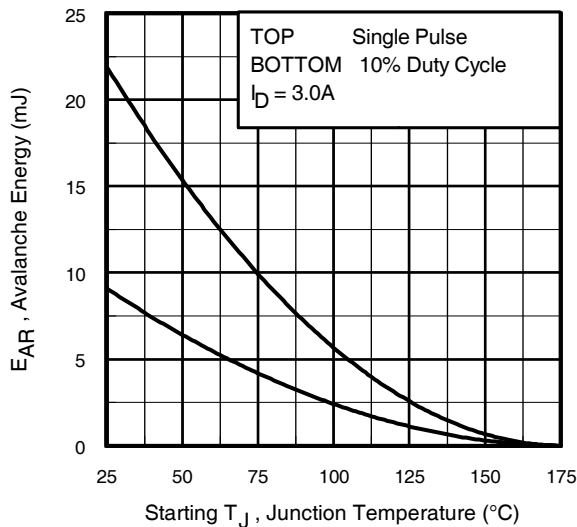
**Fig 17.** Gate Charge Test Circuit



**Fig 18.** Basic Gate Charge Waveform



**Fig 19.** Typical Avalanche Current Vs.Pulsewidth



**Fig 20.** Maximum Avalanche Energy Vs. Temperature

**Notes on Repetitive Avalanche Curves , Figures 15, 16:**  
(For further info, see AN-1005 at [www.irf.com](http://www.irf.com))

1. Avalanche failures assumption:  
Purely a thermal phenomenon and failure occurs at a temperature far in excess of  $T_{jmax}$ . This is validated for every part type.
2. Safe operation in Avalanche is allowed as long as  $T_{jmax}$  is not exceeded.
3. Equation below based on circuit and waveforms shown in Figures 12a, 12b.
4.  $P_{D(ave)}$  = Average power dissipation per single avalanche pulse.
5.  $BV$  = Rated breakdown voltage (1.3 factor accounts for voltage increase during avalanche).
6.  $I_{av}$  = Allowable avalanche current.
7.  $\Delta T$  = Allowable rise in junction temperature, not to exceed  $T_{jmax}$  (assumed as  $25^\circ\text{C}$  in Figure 15, 16).  
 $t_{av}$  = Average time in avalanche.  
 $D$  = Duty cycle in avalanche =  $t_{av} \cdot f$   
 $Z_{thJC}(D, t_{av})$  = Transient thermal resistance, see figure 11)

$$P_{D(ave)} = 1/2 ( 1.3 \cdot BV \cdot I_{av} ) = \Delta T / Z_{thJC}$$

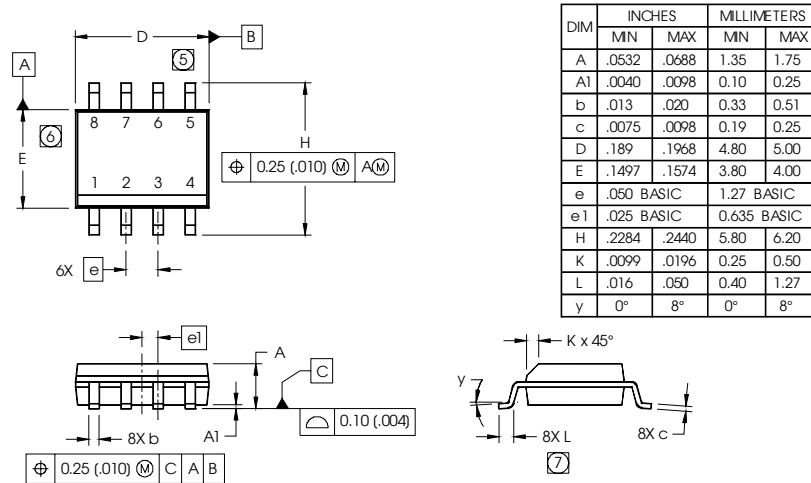
$$I_{av} = 2\Delta T / [1.3 \cdot BV \cdot Z_{th}]$$

$$E_{AS(AR)} = P_{D(ave)} \cdot t_{av}$$



## SO-8 Package Outline

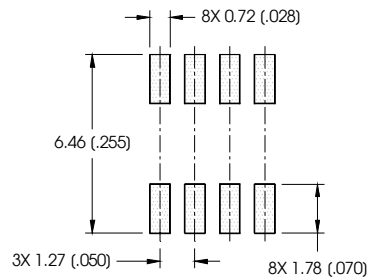
Dimensions are shown in millimeters (inches)



**NOTES:**

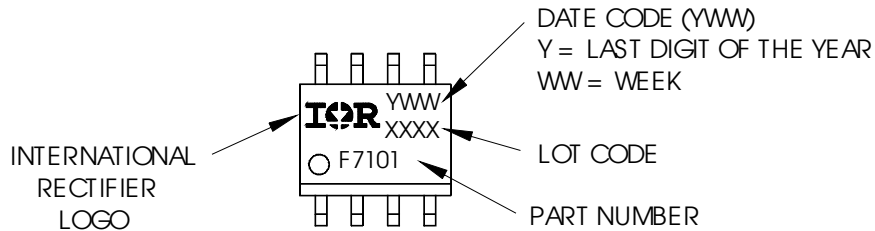
1. DIMENSIONING & TOLERANCING PER ASME Y14.5M-1994.
2. CONTROLLING DIMENSION: MILLIMETER
3. DIMENSIONS ARE SHOWN IN MILLIMETERS (INCHES).
4. OUTLINE CONFORMS TO JEDEC OUTLINE MS-012AA.
5. DIMENSION DOES NOT INCLUDE MOLD PROTRUSIONS. MOLD PROTRUSIONS NOT TO EXCEED 0.15 (.006).
6. DIMENSION DOES NOT INCLUDE MOLD PROTRUSIONS. MOLD PROTRUSIONS NOT TO EXCEED 0.25 (.010).
7. DIMENSION IS THE LENGTH OF LEAD FOR SOLDERING TO A SUBSTRATE.

**FOOTPRINT**



## SO-8 Part Marking

EXAMPLE: THIS IS AN IRF7101 (MOSFET)



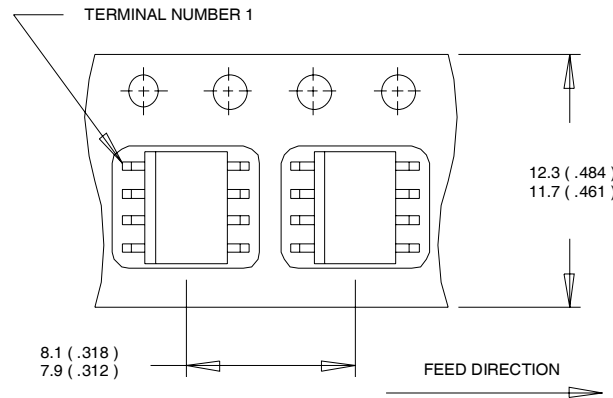
**Notes:**

1. For an Automotive Qualified version of this part please see <http://www.irf.com/product-info/auto/>
2. For the most current drawing please refer to IR website at <http://www.irf.com/package/>

# IRF7103QPbF

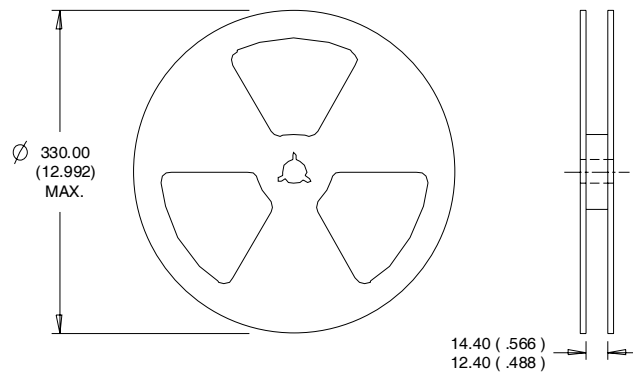
International  
**IR** Rectifier

## SO-8 Tape and Reel



### NOTES:

1. CONTROLLING DIMENSION : MILLIMETER.
2. ALL DIMENSIONS ARE SHOWN IN MILLIMETERS(INCHES).
3. OUTLINE CONFORMS TO EIA-481 & EIA-541.



### NOTES :

1. CONTROLLING DIMENSION : MILLIMETER.
2. OUTLINE CONFORMS TO EIA-481 & EIA-541.

Data and specifications subject to change without notice.  
This product has been designed and qualified for the Industrial market.  
Qualification Standards can be found on IR's Web site.

International  
**IR** Rectifier

**IR WORLD HEADQUARTERS:** 233 Kansas St., El Segundo, California 90245, USA Tel: (310) 252-7105  
TAC Fax: (310) 252-7903

Visit us at [www.irf.com](http://www.irf.com) for sales contact information.08/2010

[www.irf.com](http://www.irf.com)