

WiFi 3 click schematic v101

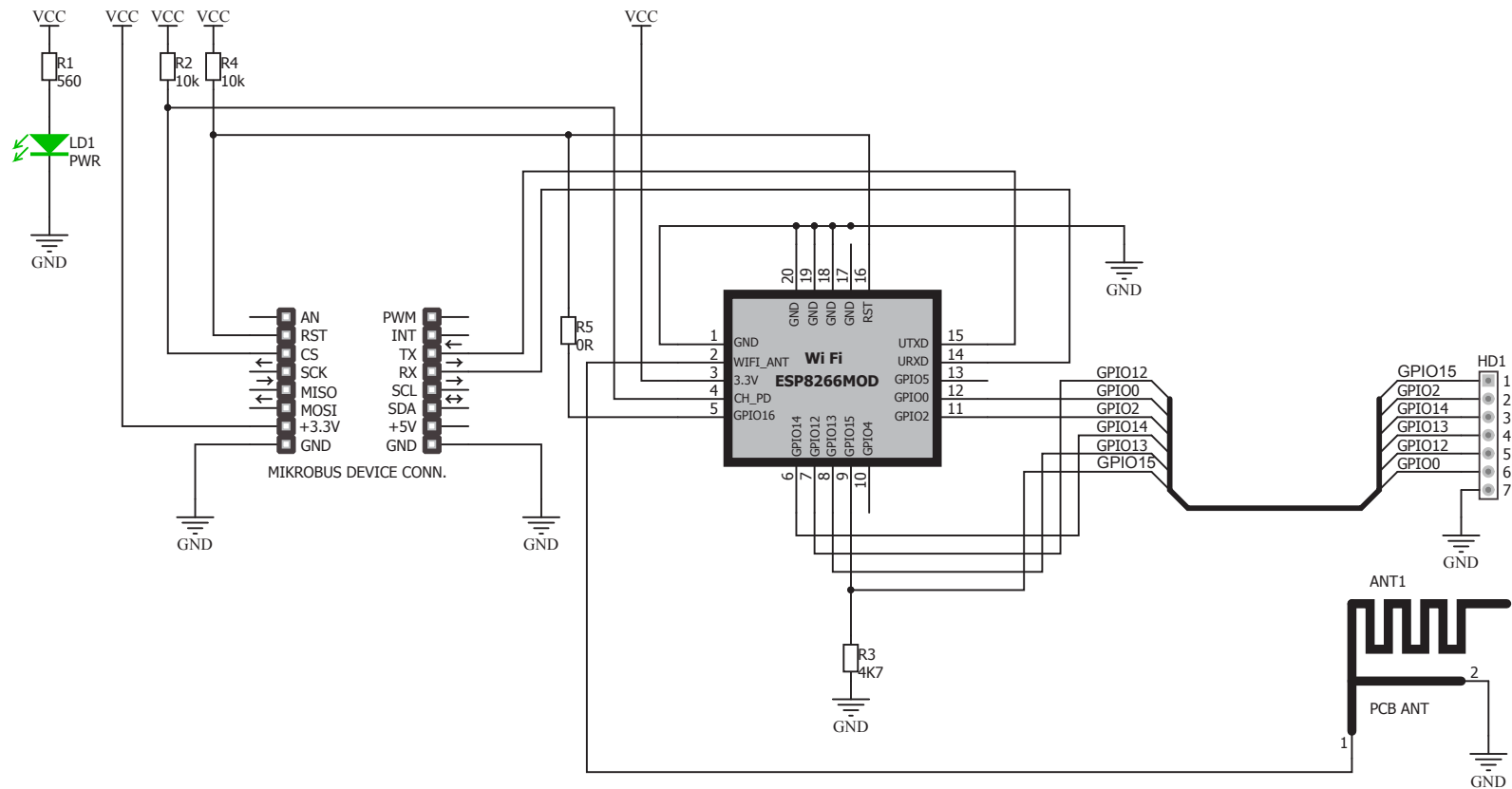

www.mikroe.com