

POWER MANAGEMENT
Description

The SC1453 is a low dropout linear regulator that operates from a +2.25V to +6.5V input range and delivers up to 150mA. A PMOS pass transistor allows the low 75 μ A supply current to remain independent of load, making these devices ideal for battery operated portable equipment such as cellular phones, cordless phones and personal digital assistants.

The SC1453 has a bandgap reference bypass pin for very low noise operation - a 10nF (typ.) capacitor may be connected between this pin and ground. Other features include low powered shutdown, short circuit protection, thermal shutdown protection and reverse battery protection. The SC1453 comes in the tiny 5 lead SOT-23 package and the ultra-low profile 5 lead TSOT-23.

Features

- ◆ "2982/5205" compatible pinout
- ◆ Guaranteed 150 mA output current
- ◆ 2% output accuracy guaranteed over line, load and temperature
- ◆ Very small external components - designed to work with ceramic capacitors
- ◆ Low 26 μ V_{RMS} output noise (1.5V option, C_{IN} = C_{OUT} = 1 μ F, C_{BYP} = 10nF)
- ◆ Very low supply current
- ◆ Thermal overload protection
- ◆ Reverse battery protection
- ◆ Low power shutdown
- ◆ Full industrial temperature range
- ◆ Very low profile packaging available (1mm max. height)
- ◆ Surface mount packaging (5 pin SOT-23 and TSOT-23)
- ◆ Available in Lead-free packages, fully WEEE and RoHS compliant

Applications

- ◆ Battery Powered Systems
- ◆ Cellular Telephones
- ◆ Cordless Telephones
- ◆ Personal Digital Assistants
- ◆ Portable Instrumentation
- ◆ Modems
- ◆ PCMCIA cards

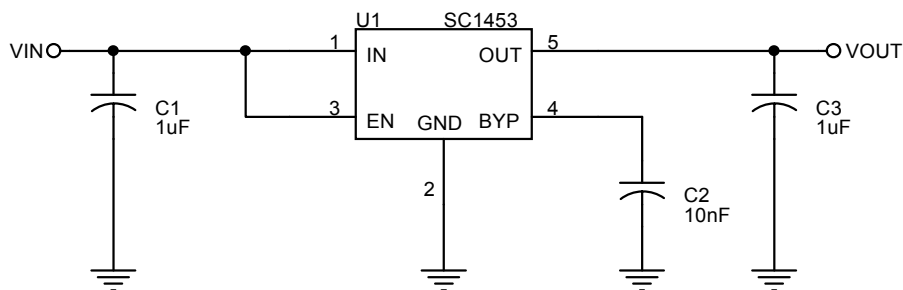
Typical Application Circuit

POWER MANAGEMENT

Absolute Maximum Ratings

Exceeding the specifications below may result in permanent damage to the device, or device malfunction. Operation outside of the parameters specified in the Electrical Characteristics section is not implied.

Parameter	Symbol	Maximum	Units
Input Supply Voltage	V_{IN}	-0.6 to +7	V
Thermal Resistance Junction to Ambient	θ_{JA}	256	°C/W
Thermal Resistance Junction to Case	θ_{JC}	81	°C/W
Operating Ambient Temperature Range	T_A	-40 to +85	°C
Operating Junction Temperature Range	T_J	-40 to +125	°C
Storage Temperature Range	T_{STG}	-65 to 150	°C
Lead Temperature (Soldering) 10 Sec.	T_{LEAD}	300	°C
ESD Rating	ESD	2	kV

Electrical Characteristics

Unless specified: $V_{IN} = V_{OUT} + 1V$, $V_{EN} = V_{IN}$, $I_{OUT} = 100\mu A$, $C_{IN} = C_{OUT} = 1\mu F$, $T_A = 25^\circ C$. Values in **bold** apply over full operating ambient temperature range.

Parameter	Symbol	Conditions	Min	Typ	Max	Units
IN						
Supply Voltage Range	V_{IN}		2.25		6.50	V
Supply Current	I_Q	$I_{OUT} = 0mA$ to 150mA $V_{IN} = 6.5V$, $V_{EN} = 0V$		75	130	μA
					160	
				0.1	1.0	μA
					1.5	
OUT						
Output Voltage ⁽¹⁾	V_{OUT}	$I_{OUT} = 1mA$	-1.5%	V_{OUT}	+1.5%	V
		$0mA \leq I_{OUT} \leq 150mA$, $V_{OUT} + 1V \leq V_{IN} \leq 5.5V$	-2.0%		+2.0%	
Line Regulation ⁽¹⁾⁽²⁾	$REG_{(LINE)}$	$(V_{OUT(NOM)} + 0.1V) \leq V_{IN} \leq 5.5V$, $I_{OUT} = 1mA$		2.5	10	mV
					12	
Load Regulation ⁽¹⁾	$REG_{(LOAD)}$	$I_{OUT} = 0.1mA$ to 150mA		-3	-10	mV
					-20	

POWER MANAGEMENT

Electrical Characteristics (Cont.)

Unless specified: $V_{IN} = V_{OUT} + 1V$, $V_{EN} = V_{IN}$, $I_{OUT} = 100\mu A$, $C_{IN} = C_{OUT} = 1\mu F$, $T_A = 25^\circ C$. Values in **bold** apply over full operating ambient temperature range.

Parameter	Symbol	Conditions	Min	Typ	Max	Units
OUT (Cont.)						
Current Limit	I_{LIM}		400			mA
Dropout Voltage ⁽¹⁾⁽³⁾	V_D	$I_{OUT} = 1mA$		1		mV
		$I_{OUT} = 50mA$		50	65	mV
					75	
		$I_{OUT} = 100mA$		100	125	mV
					155	
$I_{OUT} = 150mA$		150	190	mV		
			230			
Output Voltage Noise, $C_{OUT} = 1\mu F$	e_n	10Hz to 100kHz, $I_{OUT} = 1mA$ $C_{BYP} = 10nF$, $V_{OUT} = 1.5V$		26		μV_{RMS}
		10Hz to 100kHz, $I_{OUT} = 1mA$ $C_{BYP} = 10nF$, $V_{OUT} = 3.3V$		54		
Output Voltage Noise, $C_{OUT} = 100\mu F$	e_n	10Hz to 100kHz, $I_{OUT} = 1mA$ $C_{BYP} = 10nF$, $V_{OUT} = 1.5V$		13		μV_{RMS}
		10Hz to 100kHz, $I_{OUT} = 1mA$ $C_{BYP} = 10nF$, $V_{OUT} = 3.3V$		29		
Power Supply Rejection Ratio	PSRR	$f = 120Hz$, $C_{BYP} = 10nF$		61		dB
BYP						
Start-up Rise Time	t_r	$C_{BYP} = 10nF$		1.3		ms
EN						
Enable Input Threshold	V_{IH}	$2.25V \leq V_{IN} \leq 6.5V$	1.6			V
	V_{IL}	$2.25V \leq V_{IN} \leq 6.5V$			0.4	
Enable Input Bias Current ⁽⁴⁾	I_{EN}	$0V \leq V_{EN} \leq V_{IN}$	-0.5	0	+0.5	μA
Over Temperature Protection						
High Trip Level	T_{HI}			150		$^\circ C$
Hysteresis	T_{HYST}			20		$^\circ C$

Notes:

- (1) Low duty cycle pulse testing with Kelvin connections required.
- (2) $V_{IN(MIN)} = 2.25V$.
- (3) Defined as the input to output differential at which the output voltage drops 100mV below the value measured at a differential of 1V. Not measurable on 1.5V and 1.8V parts due to minimum V_{IN} constraints.
- (4) Guaranteed by design.

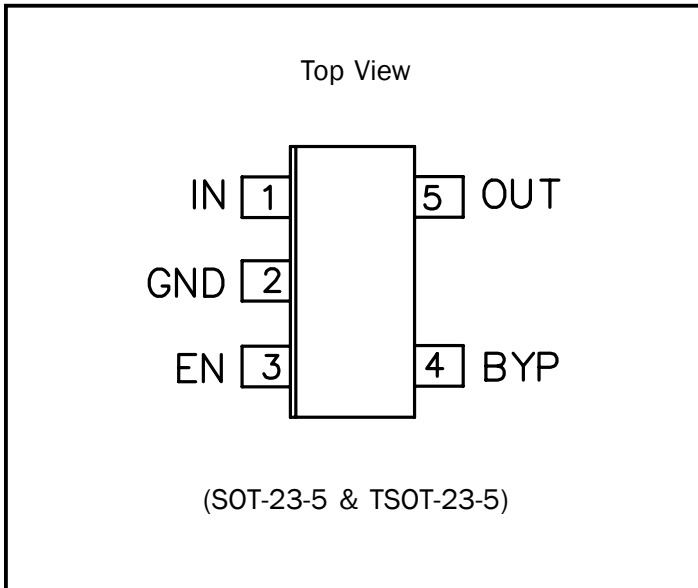
POWER MANAGEMENT
Pin Configuration

Pin Descriptions

Pin #	Pin Name	Pin Function
1	IN	Input pin.
2	GND	Ground pin. Can be used for heatsinking if needed.
3	EN	Active high enable pin. Connect to IN if not being used.
4	BYP	Reference bypass. Connect a 10nF capacitor (typical) between this pin and GND to reduce output noise.
5	OUT	Regulator output, sourcing up to 150mA.

POWER MANAGEMENT

Ordering Information

Package	Voltage Option (V)	Part Number
SOT-23-5 ⁽¹⁾	1.5	SC1453ISK-1.5TR
	1.8	SC1453ISK-1.8TR
	2.5	SC1453ISK-2.5TR
	2.7	SC1453ISK-2.7TR
	2.8	SC1453ISK-2.8TR
	2.9	SC1453ISK-2.9TR
	3.0	SC1453ISK-3.0TR
	3.1	SC1453ISK-3.1TR
	3.2	SC1453ISK-3.2TR
	3.3	SC1453ISK-3.3TR
Lead-free SOT-23-5 ⁽¹⁾⁽²⁾	1.5	SC1453ISK1.5TRT
	1.8	SC1453ISK18TRT
	2.5	SC1453ISK2.5TRT
	2.7	SC1453ISK2.7TRT
	2.8	SC1453ISK2.8TRT
	2.9	SC1453ISK2.9TRT
	3.0	SC1453ISK3.0TRT
	3.1	SC1453ISK3.1TRT
	3.2	SC1453ISK3.2TRT
	3.3	SC1453ISK33TRT

Package	Voltage Option (V)	Part Number
TSOT-23-5 ⁽¹⁾	1.5	SC1453ITSK1.5TR
	1.8	SC1453ITSK1.8TR
	2.5	SC1453ITSK2.5TR
	2.7	SC1453ITSK2.7TR
	2.8	SC1453ITSK2.8TR
	2.85	SC1453ITSK285TR
	2.9	SC1453ITSK2.9TR
	3.0	SC1453ITSK3.0TR
	3.1	SC1453ITSK3.1TR
	3.2	SC1453ITSK3.2TR
Lead-free TSOT-23-5 ⁽¹⁾⁽²⁾	3.3	SC1453ITSK3.3TR
	1.5	SC1453ITSK15TRT
	1.8	SC1453ITSK18TRT
	2.5	SC1453ITSK25TRT
	2.7	SC1453ITSK27TRT
	2.8	SC1453ITSK28TRT
	2.85	SC1453TSK285TRT
	2.9	SC1453ITSK29TRT
	3.0	SC1453ITSK30TRT
	3.1	SC1453ITSK31TRT
Evaluation Board ⁽³⁾	3.2	SC1453ITSK32TRT
	3.3	SC1453ITSK33TRT
	Specify	SC1453EVB

Notes:

(1) Only available in tape and reel packaging. A reel contains 3000 devices.

(2) Lead free packaging (ordered with suffix extension "TRT") is optional. Consult factory for availability. This product is fully WEEE and RoHS compliant.

(3) Evaluation board for SC1453. Specify output voltage option when ordering.

POWER MANAGEMENT

Marking Information

Top Mark

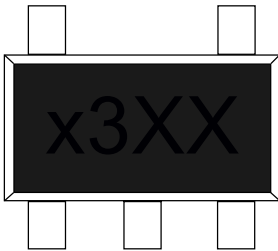

x = package (5 for SOT-23-5, T for TSOT-23-5)
 3 = SC1453
 XX = voltage option
 (examples: 5331 for 3.1V option in SOT-23-5)

Bottom Mark

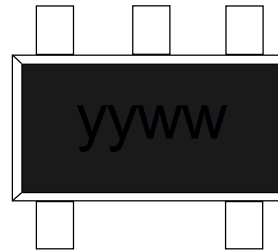

yyww = Date code
 (example: 0008 for week 8 of 2000)

Top Mark

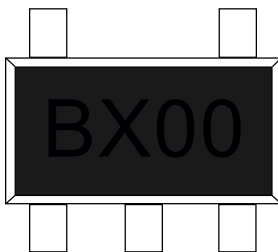

For SC1453, 2.85V option:
 X = L for SOT-23-5 and N for TSOT-23-5

Bottom Mark

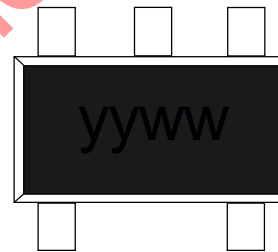

yyww = Date code
 (example: 0008 for week 8 of 2000)

Block Diagram

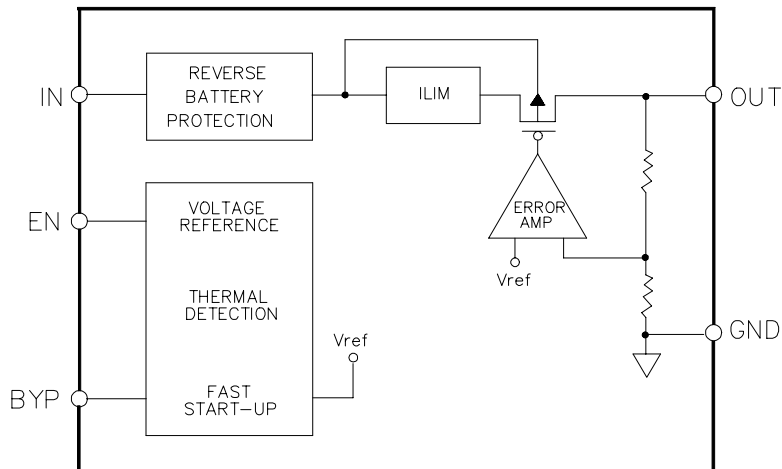

POWER MANAGEMENT

Applications Information

Theory Of Operation

The SC1453 is intended for applications where very low dropout voltage, low supply current and low output noise are critical. It provides a very simple, low cost solution that uses very little pcb real estate. Only three external capacitors are required for operation (two if a low noise output is not required).

The SC1453 contains a bandgap reference trimmed for optimal temperature coefficient which is fed into the inverting input of an error amplifier. The output voltage of the regulator is divided down internally using a resistor divider and compared to the bandgap voltage. The error amplifier drives the gate of a low $R_{DS(ON)}$ P-channel MOSFET pass device.

An active high enable pin (EN) allows the regulator to be shut down. Pulling this pin low causes the device to enter a very low power shutdown mode, where it will draw typically 0.1µA from the input supply.

A bypass pin (BYP) is provided to decouple the bandgap reference to reduce output noise and also to improve power supply rejection. This pin can be left open if low noise operation is not required.

The regulator has its own current limit circuitry to ensure that the output current will not damage the device during output short, overload or start-up. The current limit is guaranteed to be greater than 400mA to allow fast charging of the output capacitor and high initial currents for DSP initialization.

The SC1453 has a fast start-up circuit to speed up the initial charging time of the bypass capacitor to enable the output voltage to come up quicker (typically 1.3ms with $C_{BYP} = 10nF$).

The SC1453 includes thermal shutdown circuitry to turn off the device if T_j exceeds 150°C (typical), with the device remaining off until T_j drops by 20°C (typical). Reverse battery protection circuitry ensures that the device cannot be damaged if the input supply is accidentally reversed, limiting the reverse current to less than 1.5mA.

Component Selection - General

Output capacitor - Semtech recommends a minimum capacitance of 1µF at the output with an equivalent series resistance (ESR) of < 1Ω over temperature. While the SC1453 has been designed to be used with ceramic capacitors, it does not have to be used with ceramic capacitors, allowing the designer a choice. Increasing the bulk capacitance will further reduce output noise and improve the overall transient response.

Input capacitor - Semtech recommends the use of a 1µF ceramic capacitor at the input. This allows for the device being some distance from any bulk capacitance on the rail. Additionally, input droop due to load transients is reduced, improving overall load transient response.

Bypass capacitor - Semtech recommends the use of a 10nF ceramic capacitor to bypass the bandgap reference. Increasing this capacitor to 100nF will further improve power supply rejection and overall output noise. C_{BYP} may be omitted if low noise operation is not required.

Thermal Considerations

The worst-case power dissipation for this part is given by:

$$P_{D(MAX)} = (V_{IN(MAX)} - V_{OUT(MIN)}) \cdot I_{OUT(MAX)} + V_{IN(MAX)} \cdot I_{Q(MAX)} \quad (1)$$

For all practical purposes, equation (1) can be reduced to the following expression:

$$P_{D(MAX)} = (V_{IN(MAX)} - V_{OUT(MIN)}) \cdot I_{OUT(MAX)} \quad (2)$$

Looking at a typical application, 3.3V to 2.8V at 150mA:

$$\begin{aligned} V_{IN(MAX)} &= 3.3 + 5\% = 3.465V \\ V_{OUT(MIN)} &= 2.8V - 2\% = 2.744V \\ I_{OUT} &= 150mA \\ T_A &= 85^\circ C \end{aligned}$$

POWER MANAGEMENT

Applications Information (Cont.)

Inserting these values into equation (2) gives us:

$$P_{D(MAX)} = (3.465 - 2.744) \cdot 0.150 = 108\text{mW}$$

Using this figure, we can calculate the maximum thermal impedance allowable to maintain $T_J \leq 125^\circ\text{C}$:

$$\theta_{JA(MAX)} = \frac{(T_{J(MAX)} - T_{A(MAX)})}{P_{D(MAX)}} = \frac{(125 - 85)}{0.108} = 370^\circ\text{C/W}$$

With the standard SOT-23-5/TSOT-23-5 Land Pattern shown at the end of this datasheet, and minimum trace widths, the thermal impedance junction to ambient for SC1453ISK is 256°C/W . Thus no additional heatsinking is required for this example.

The junction temperature can be reduced further (or higher power dissipation can be allowed) by the use of larger trace widths and connecting PCB copper to the GND pin (pin 2), which connects directly to the device substrate. Adding approximately one square inch of PCB copper to pin 2 will reduce θ_{JA} to approximately 130°C/W and $T_{J(MAX)}$ for the example above to approximately 100°C for the SOT-23-5 package. The use of multi layer boards with internal ground/power planes will lower the junction temperature and improve overall output voltage accuracy.

Layout Considerations

While layout for linear devices is generally not as critical as for a switching application, careful attention to detail will ensure reliable operation.

- 1) Attaching the part to a larger copper footprint will enable better heat transfer from the device, especially on PCBs where there are internal ground and power planes.
- 2) Place the input, output and bypass capacitors close to the device for optimal transient response and device behaviour.
- 3) Connect all ground connections directly to the ground plane. If there is no ground plane, connect to a common local ground point before connecting to board ground.

NOT RECOMMENDED FOR NEW DESIGN

POWER MANAGEMENT

Typical Characteristics

Quiescent Current vs. Junction Temperature vs. Input Voltage

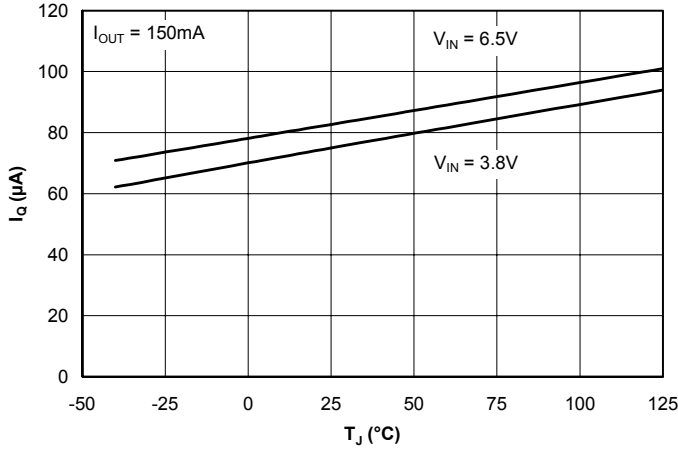

Off-State Quiescent Current vs. Junction Temperature

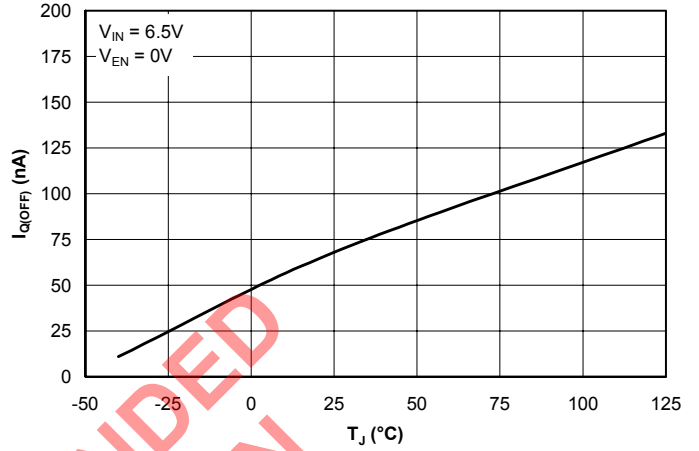

Output Voltage vs. Junction Temperature vs. Output Current

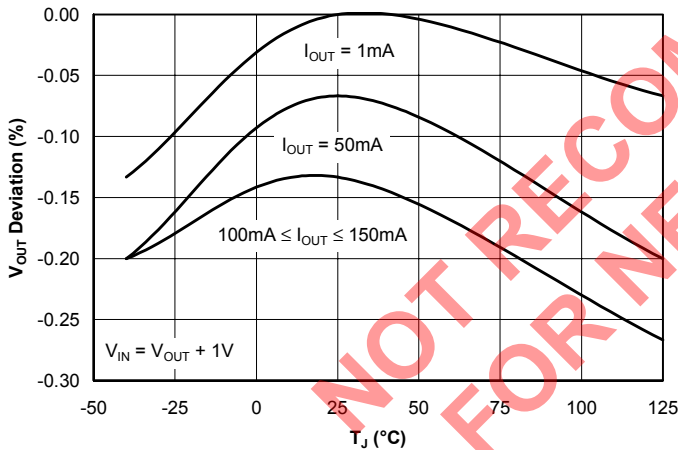

Line Regulation vs. Junction Temperature vs. Input Voltage Change

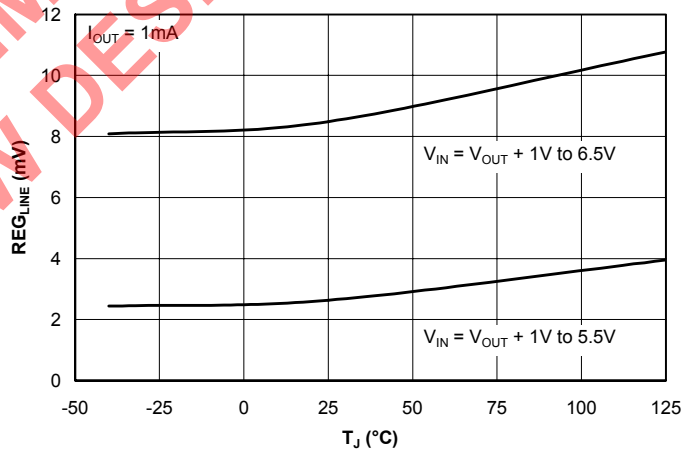

Load Regulation vs. Junction Temperature

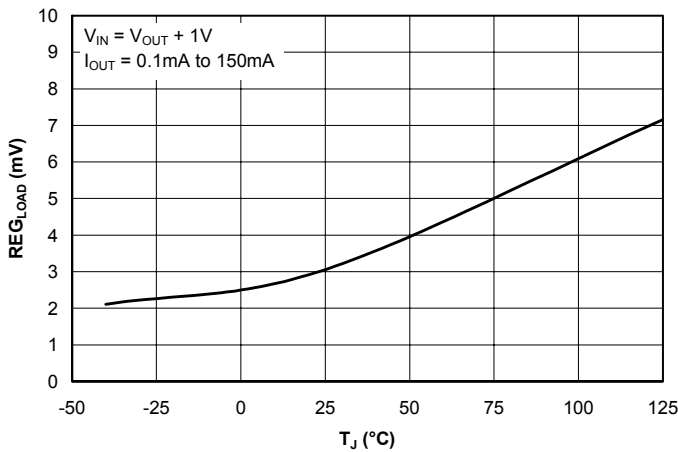

Current Limit vs. Junction Temperature vs. Input Voltage

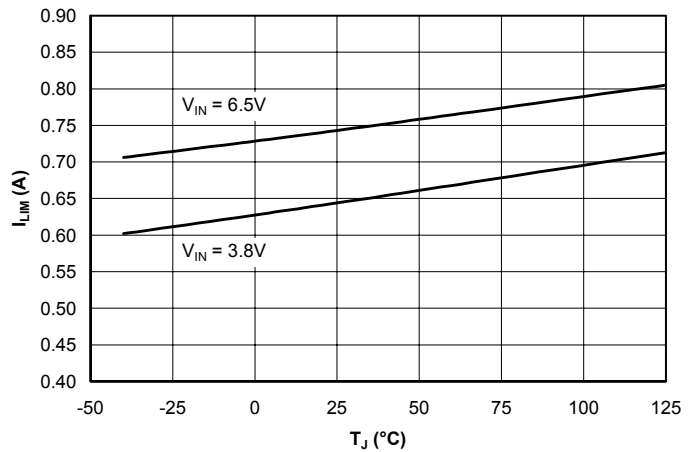

POWER MANAGEMENT

Typical Characteristics (Cont.)

Dropout Voltage vs. Junction Temperature vs. Output Current

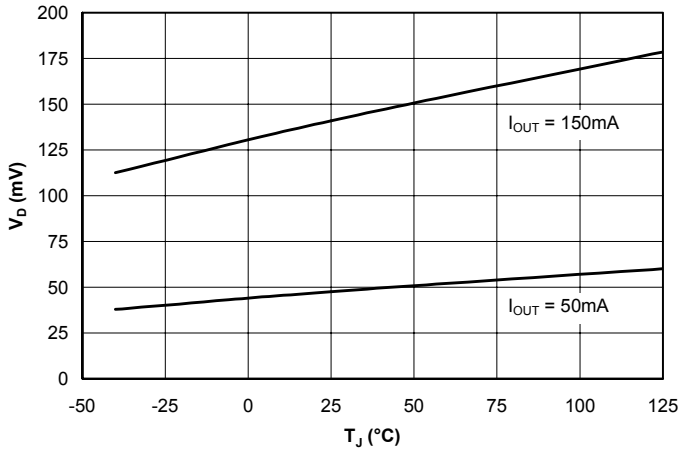

Dropout Voltage vs. Output Current vs. Junction Temperature

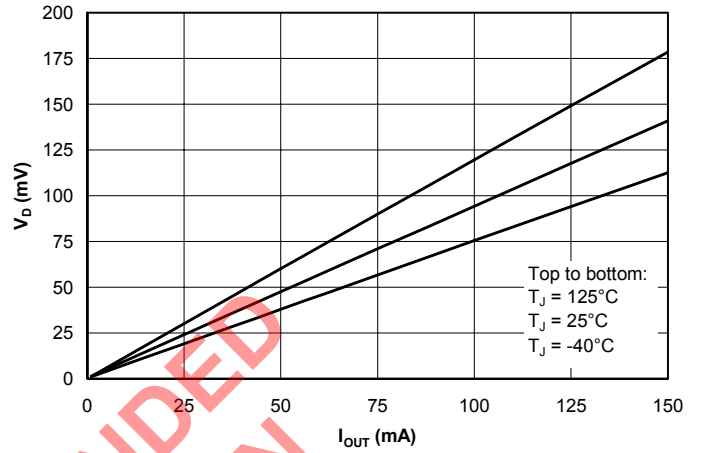

Bypass Start-up Rise Time vs. Junction Temperature vs. Input Voltage

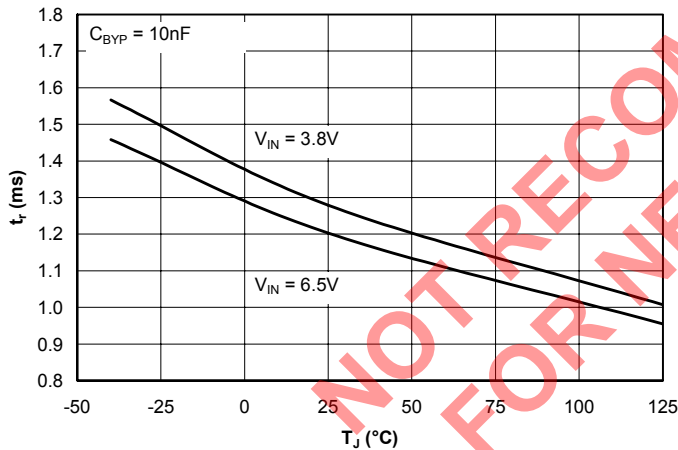

Enable Input Threshold Voltage vs. Junction Temperature vs. Input Voltage

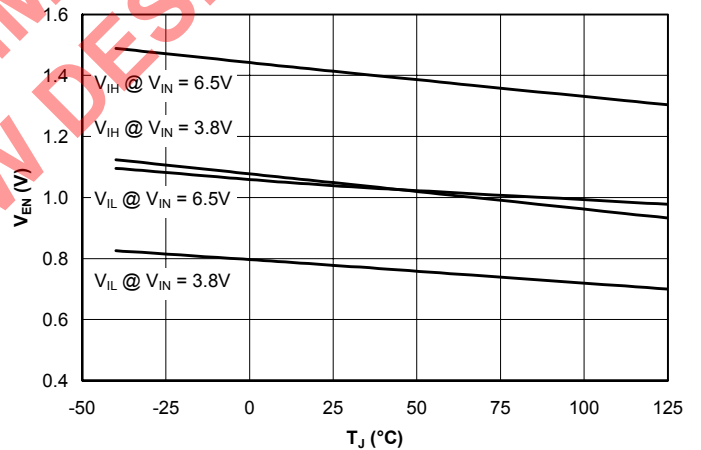

Reverse Battery Protection vs. Junction Temperature

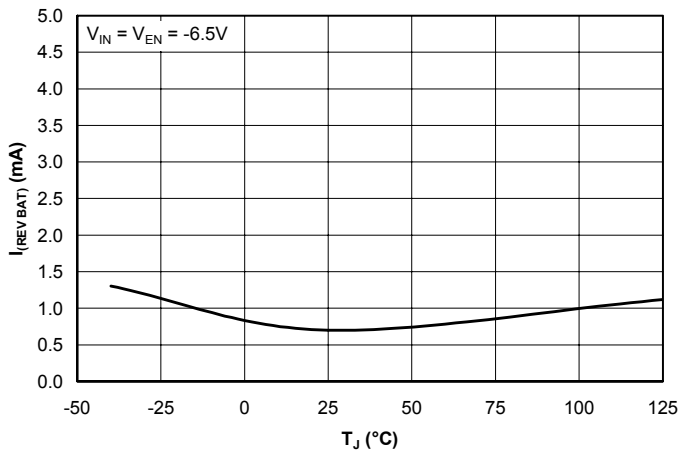

Output Spectral Noise Density vs. Frequency vs. Output Voltage, Cout = 1µF

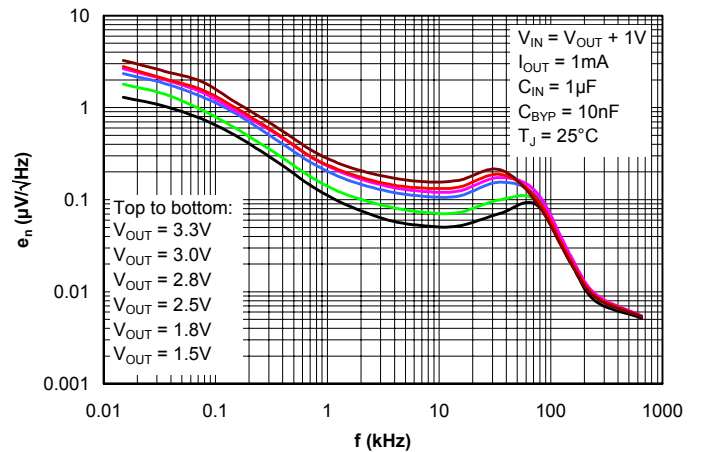

POWER MANAGEMENT

Typical Characteristics (Cont.)

Output Spectral Noise Density vs. Frequency vs. Output Voltage, $C_{OUT} = 100\mu F$

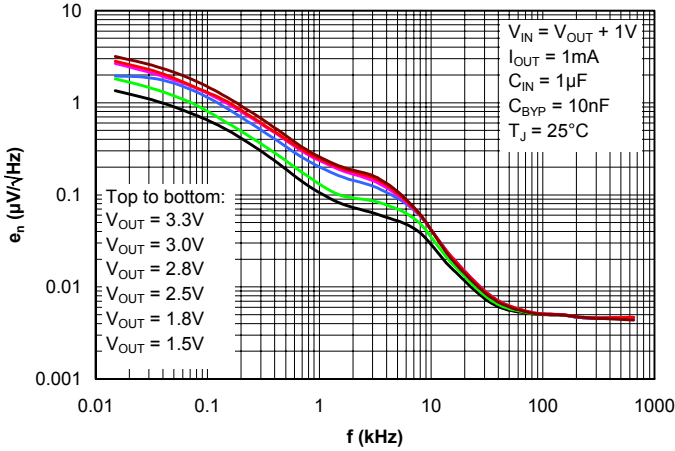

Output Spectral Noise Density vs. Frequency vs. Output Capacitance

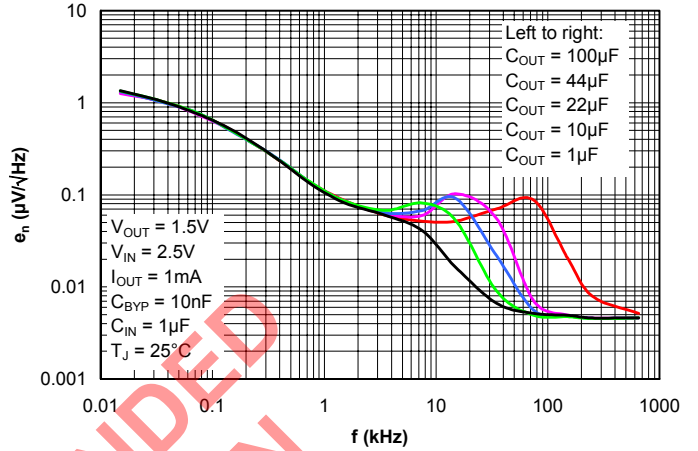

Output Spectral Noise Density vs. Frequency vs. Bypass Capacitance

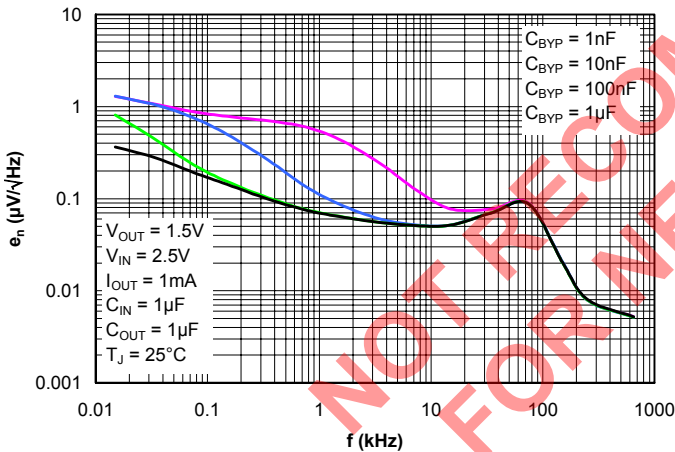

Output Spectral Noise Density vs. Frequency vs. Output Current

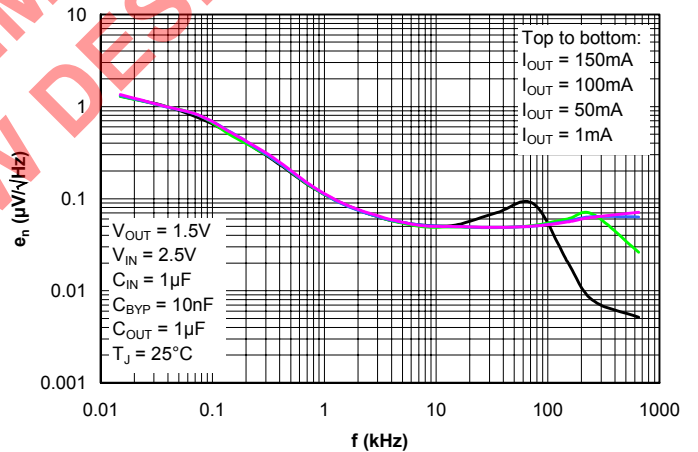

Power Supply Rejection Ratio vs. Frequency vs. Output Voltage, $C_{BYP} = 10nF$

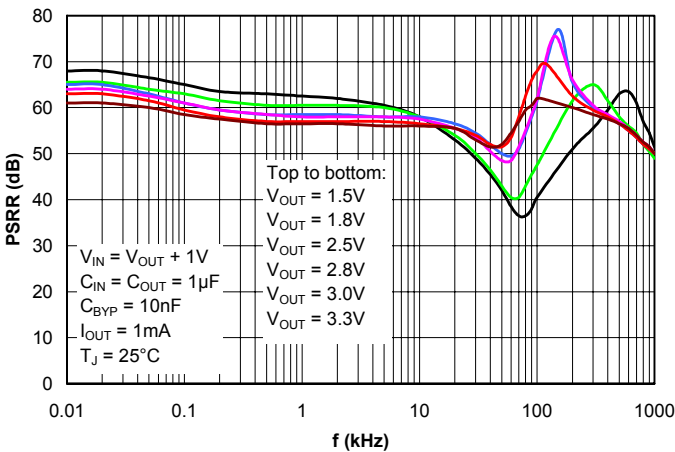

Power Supply Rejection Ratio vs. Frequency vs. Output Voltage, $C_{BYP} = 100nF$

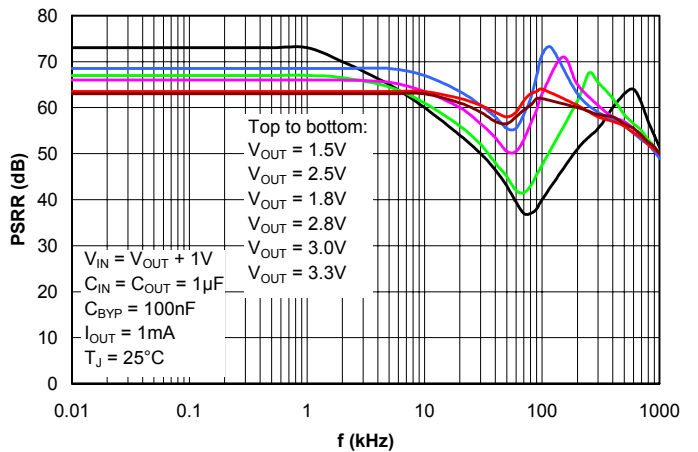

POWER MANAGEMENT

Evaluation Board Schematic

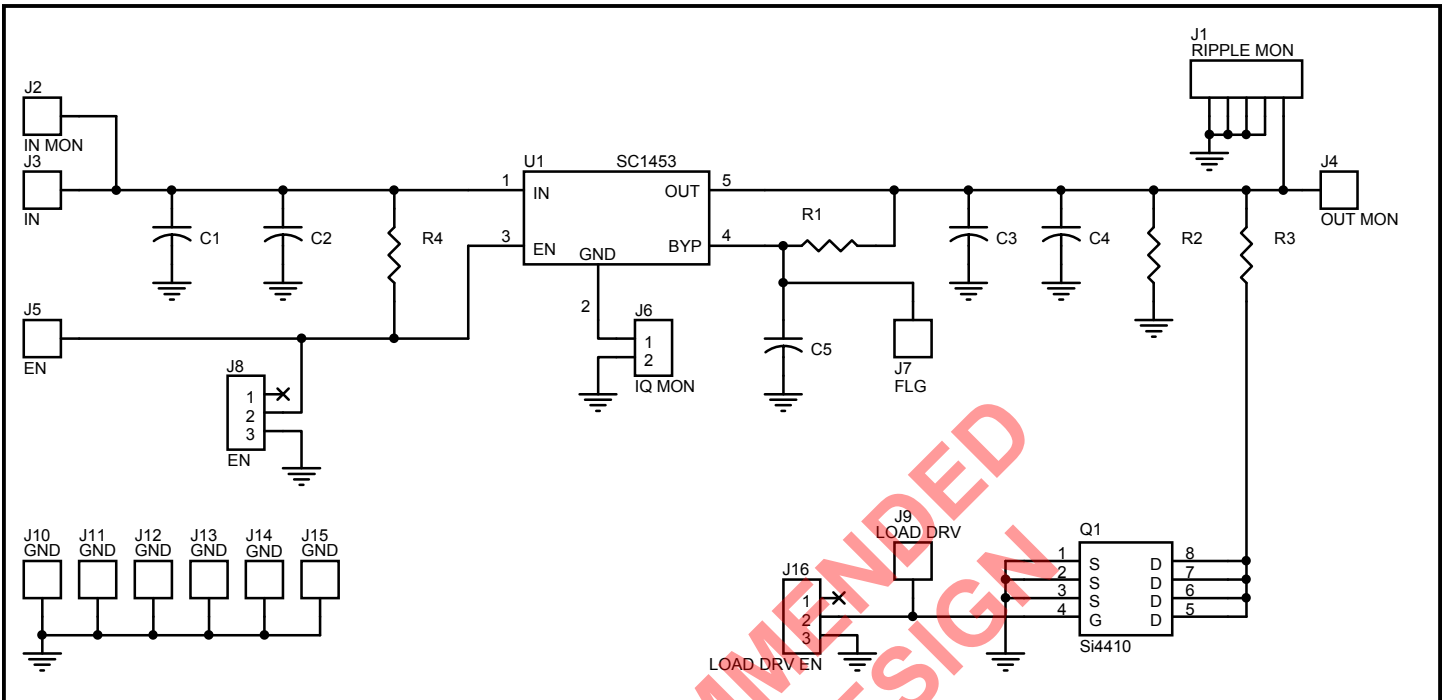

Evaluation Board Bill of Materials

Quantity	Reference	Part/Description	Vendor	Notes
2	C1, C4	Not placed		
2	C2, C3	1 μ F ceramic	Murata	GRM42-6X7R105K10
1	C5	10nF ceramic	Various	
1	J1	BNC socket	Various	V _{OUT} ripple monitor
3	J2 - J4	Test pin	Various	Red
1	J5	Test pin	Various	White
1	J6	Header, 2 pin	Various	
1	J7	Not placed		
2	J8, J16	Header, 3 pin	Various	
1	J9	Test pin	Various	Orange
6	J10 - J15	Test pin	Various	Black (J14 not placed)
1	Q1	Si4410	Vishay	
2	R1, R2	Not placed		
1	R3	See next page	Various	
1	R4	10k Ω , 1/10W	Various	
1	U1	SC1453ISK-X.X or SC1453ITSK-XX	Semtech	

POWER MANAGEMENT

Evaluation Board Gerber Plots

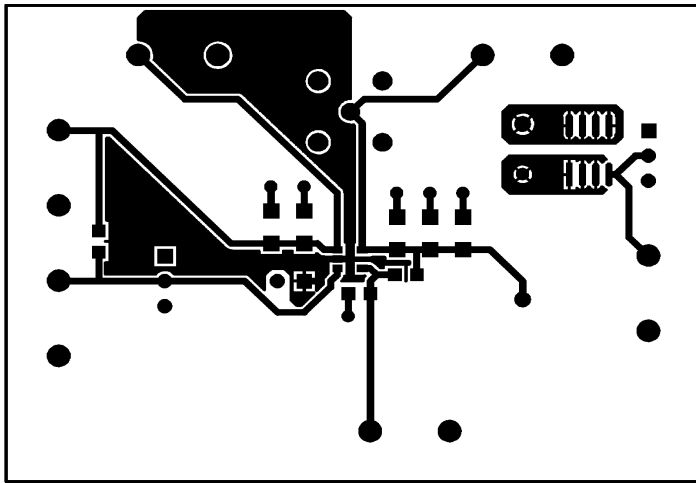

Top Copper

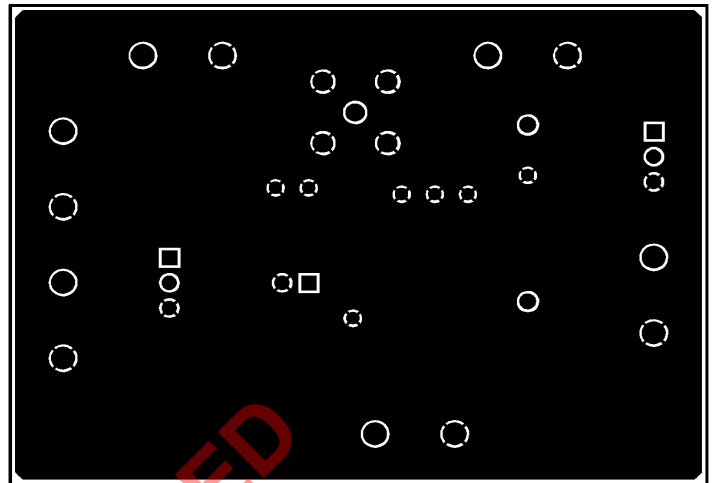

Bottom Copper

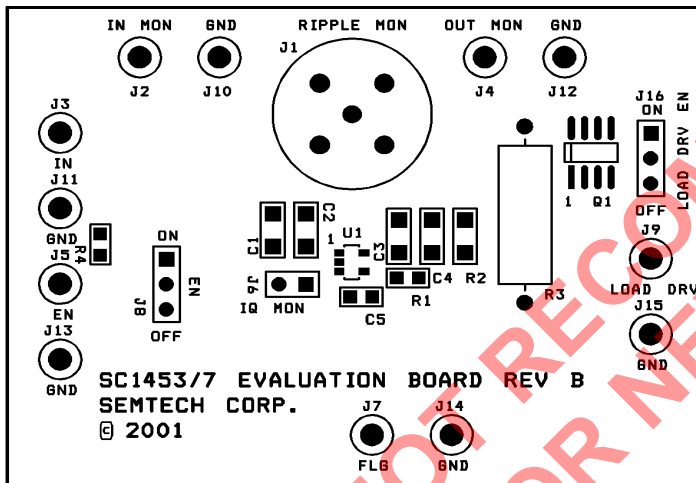

Top Silk Screen

Output Voltage Option (V)	R3 Value/Size
1.5	10Ω/0.5W
1.8	12Ω/0.5W
2.5	16Ω/0.5W
2.6	16Ω/0.5W
2.7	18Ω/0.5W
2.8	18Ω/0.5W
2.85	18Ω/0.5W
2.9	18Ω/0.5W
3.0	20Ω/0.5W
3.1	20Ω/0.5W
3.2	22Ω/0.5W
3.3	22Ω/0.5W

POWER MANAGEMENT

Outline Drawing - SOT-23-5

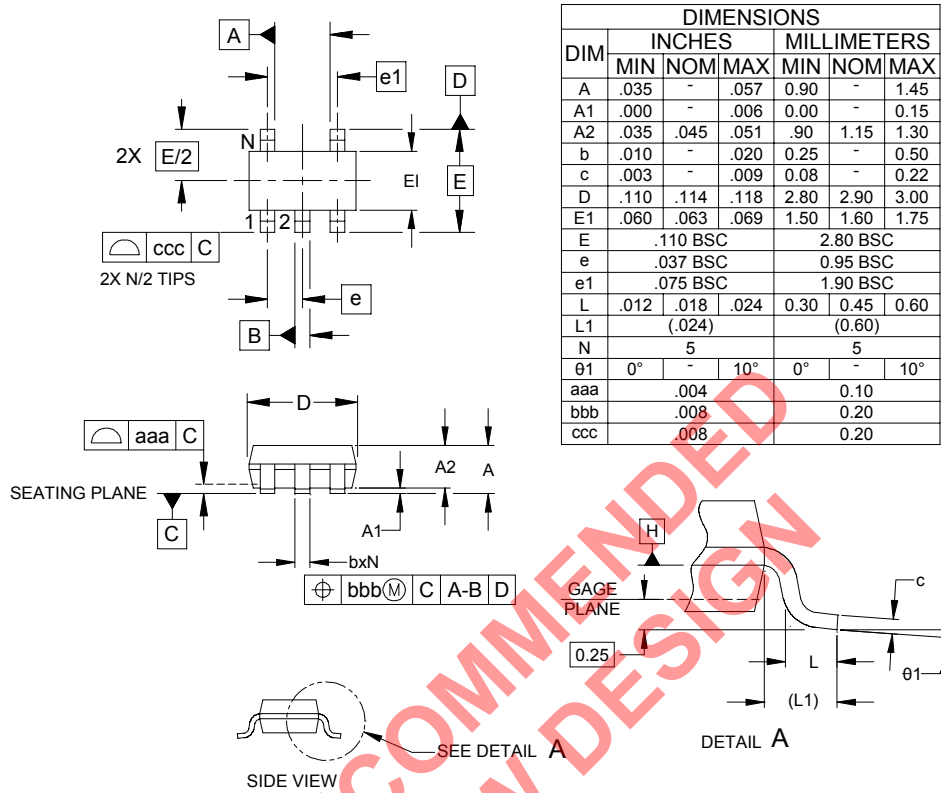

NOTES:

1. CONTROLLING DIMENSIONS ARE IN MILLIMETERS (ANGLES IN DEGREES).
2. DATUMS **-A-** AND **-B-** TO BE DETERMINED AT DATUM PLANE **-H-**
3. DIMENSIONS "E1" AND "D" DO NOT INCLUDE MOLD FLASH, PROTRUSIONS OR GATE BURRS.

Land Pattern - SOT-23-5

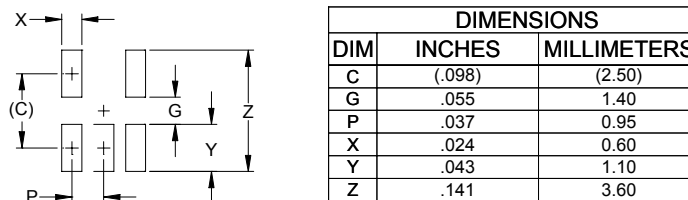

NOTES:

1. THIS LAND PATTERN IS FOR REFERENCE PURPOSES ONLY. CONSULT YOUR MANUFACTURING GROUP TO ENSURE YOUR COMPANY'S MANUFACTURING GUIDELINES ARE MET.

POWER MANAGEMENT

Outline Drawing - TSOT-23-5

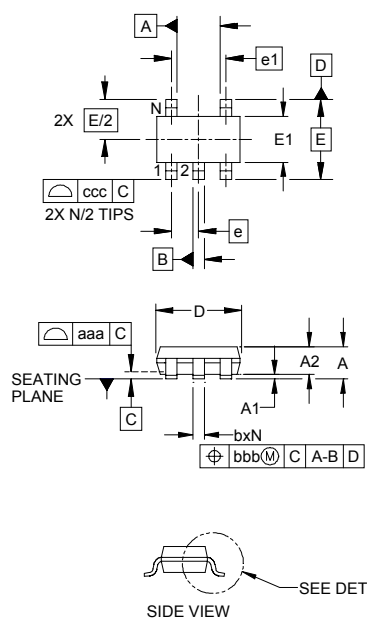

DIM	INCHES			MILLIMETERS		
	MIN	NOM	MAX	MIN	NOM	MAX
A	-	-	.039	-	-	1.00
A1	.000	-	.004	0.00	-	0.10
A2	.028	-	.035	0.70	-	0.90
b	.012	-	.020	0.30	-	0.50
c	.003	-	.008	0.08	-	0.20
D	.110	.114	.118	2.80	2.90	3.00
E1	.060	.063	.067	1.50	1.60	1.70
E	.110 BSC			2.80 BSC		
e	.037 BSC			0.95 BSC		
e1	.075 BSC			1.90 BSC		
L	.012	.018	.024	0.30	0.45	0.60
L1	(.024)			(0.60)		
N	5			5		
theta1	0°	-	8°	0°	-	8°
aaa	.004			0.10		
bbb	.008			0.20		
ccc	.010			0.25		

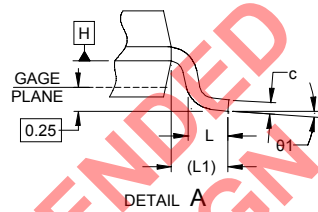

- NOTES:
1. CONTROLLING DIMENSIONS ARE IN MILLIMETERS (ANGLES IN DEGREES).
 2. DATUMS **-A-** AND **-B-** TO BE DETERMINED AT DATUM PLANE **-H-**
 3. DIMENSIONS "E1" AND "D" DO NOT INCLUDE MOLD FLASH, PROTRUSIONS OR GATE BURRS.
 4. REFERENCE JEDEC STD MO-193, VARIATION AB.

Land Pattern - TSOT-23-5

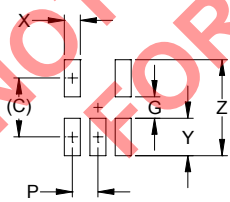

DIM	INCHES	MILLIMETERS
C	(.087)	(2.20)
G	.031	0.80
P	.037	0.95
X	.024	0.60
Y	.055	1.40
Z	.141	3.60

- NOTES:
1. THIS LAND PATTERN IS FOR REFERENCE PURPOSES ONLY. CONSULT YOUR MANUFACTURING GROUP TO ENSURE YOUR COMPANY'S MANUFACTURING GUIDELINES ARE MET.

Contact Information

Semtech Corporation
 Power Management Products Division
 200 Flynn Road, Camarillo, CA 93012
 Phone: (805)498-2111 FAX (805)498-3804