



## Part Number: D4I8016

### Electrical Specifications

Frequency Range (GHz):	7.7 - 8.4
Isolation (dB):	34 MIN
Insertion Loss (dB):	1.2 MAX
VSWR:	1.35:1 MIN
Forward Power (W):	10 AVG 30 PK
Reflective Power (W):	2 AVG

### Mechanical/Environmental Specifications

Connector Type:	SMA
Connector Body:	Passivated stainless steel
Connector Pin:	Gold plated copper
Load Body:	Brass
Magnetic Shunt:	Nickel plated CRS
Operational Temp:	-20°C to +65°C
Weight (oz)	2.0 MAX

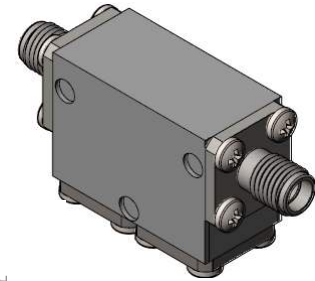

### D4I8016 Dimensions

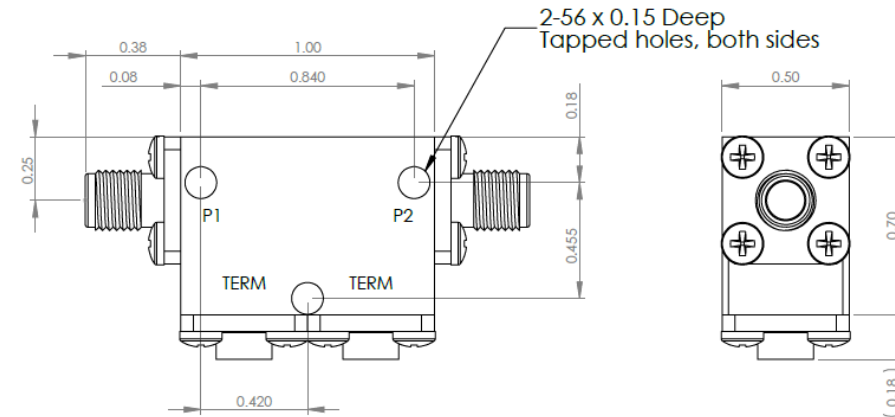

### D4I8016-3 Dimensions

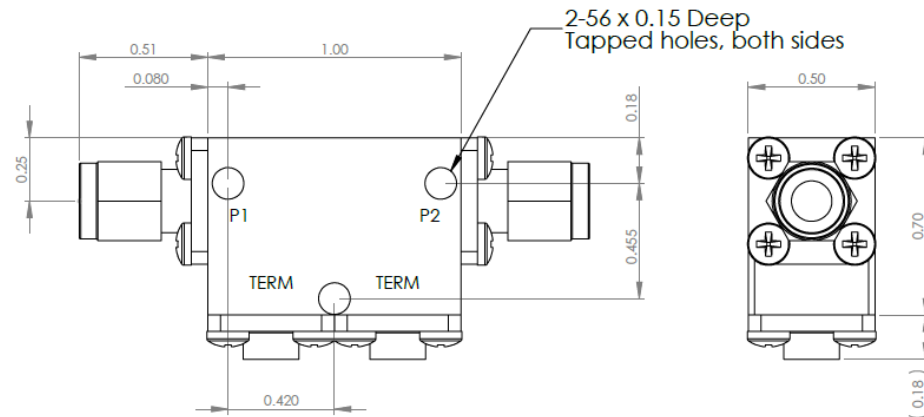

Dimensions are in inches  
Tolerance

XX ±0.03  
XXX ±0.010

Type of Device	PN Suffix	Connector Configuration Input / Output	PN Example
Single and Dual Junction Isolator, 2-Port Device  Input / Output	N/A	Female / Female	D4I8016
	-1	Male / Female	D4I8016-1
	-2	Female / Male	D4I8016-2
	-3	Male / Male	D4I8016-3



# MEASURED DATA

Part Number: D4I8016, +25°C

