

AR1086CHSCT



Sample image

Order symbol: AR1086CHSCT

Product nbr: 8561018

Description: PC Enclosure

Remarks: Hinged transparent screw cover

EAN: 6418074066565

El. number:

- Finland:
- Denmark:
- Sweden:

Including: Hinged screw cover. Base with 10-32 brass inserts, cover with formed in place PUR gasket, stainless hinge pin and 2 cover screws. Enclosure mounting foot kit. Accessory 10-32 screws for panel mounting.

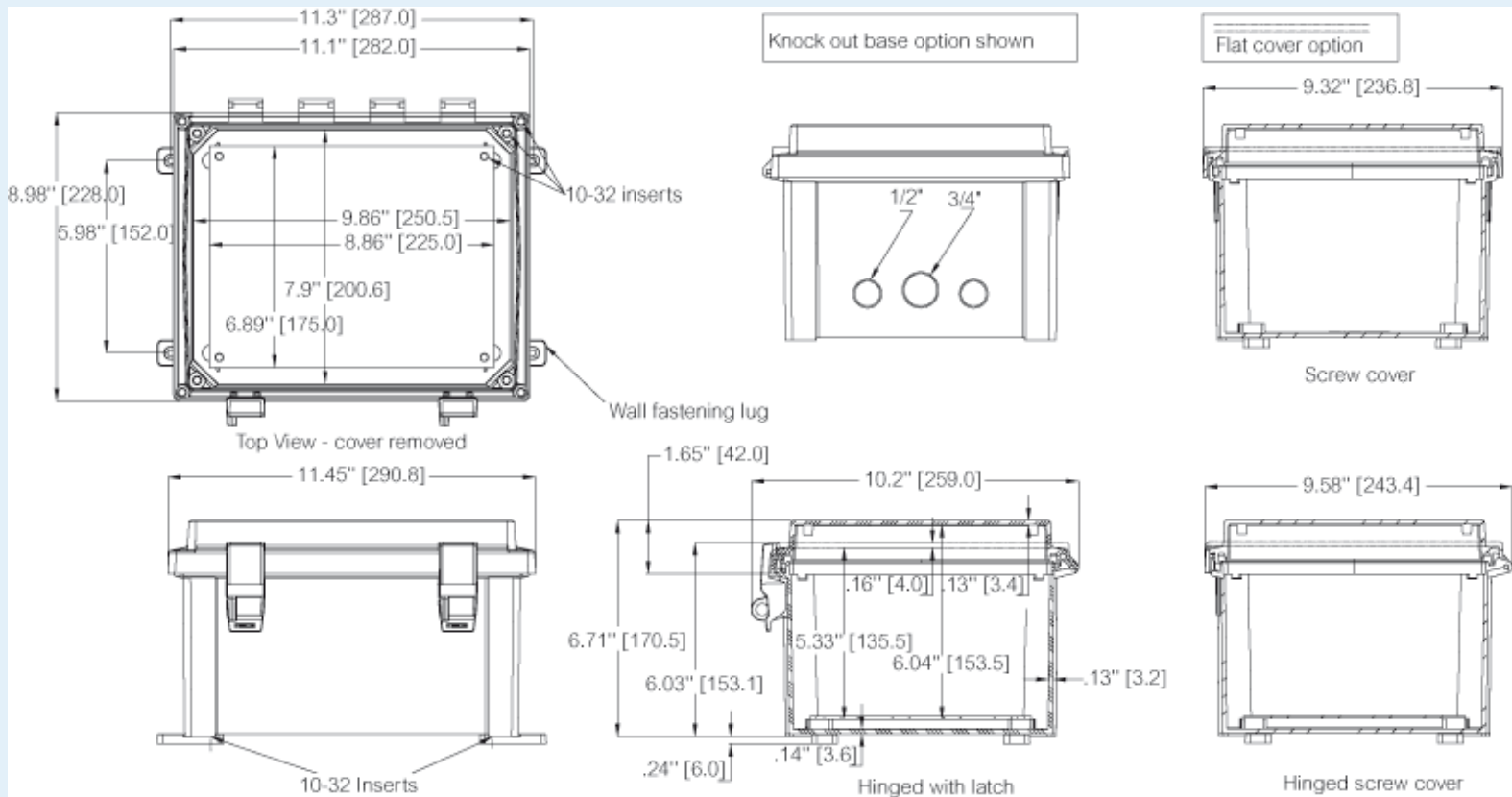

Dimensions:	Height	Width	Depth
mm:	254	203	152
inch:	10	8	6

Accessories:

ASPHK10	Swing Panel Kit w/o Panel
ABP108	Painted Steel Back Panel

Materials:

Material:	Polycarbonate
Base colour:	RAL 7035 -light grey
Cover colour:	Transparent
Gasket material:	Polyurethane

Temperatures:

Temperature °C (short term)::	-40 ... 140
Temperature °C (continuous):	-40 ... 80
Temperature °F (short term):	-40 ... 250
Temperature °F (continuous):	-40 ... 175

(226 x 175)

ADFP108	Dead Front Panel w/ screws (208 x 256 x 0)
ASP108	Aluminum Swing Panel (204.5 x 255 x 0)
ASPK108	Swing Panel Kit incl. Panel
ALBP108	Aluminum Back Panel (226 x 175)
AMFL8	8" Mounting Flange Set
APBP108	PVC Back Panel (226 x 175)

Rating:

Ingress protection (EN 60529):	IP66; IP67;
Impact Resistance (EN 62262):	IK09;
Electrical insulation:	Not insulated
Halogen free (DIN/VDE 0472, Part 815):	1
UV resistance:	UL 508
Flammability Rating:	UL 508
Glow Wire Test (IEC 695-2-1) °C:	960 °C
NEMA Class	NEMA 4, 4X, 6, 6P, 12, 12K and 13

Certificates:

ARCA_CertificateofCompliance