

Mounting Feet

Mounting Flanges



Features & Benefits

- **Quality material** – bases, opaque covers and clear covers are all made of high-impact, UV resistant polycarbonate.
- **Flexible interior mounting** – features the unique and patented Integra adjustable depth “T-Rail” back panel mounting system (back panel and adjustable brackets sold separately).
- **Wide range** of sizes, configurations and accessories provides capabilities for every application.
- **Brass inserts** – in corner bosses for easy component installation.
- **Standard color** – light gray with a gloss finish.
- **UL-50 / c-UL Listed** (files # E229365, # E207562)

Mechanical & Thermal	Test Spec.	Unit	Rating
Instrumented Dart Impact @ 73° F	-	in-lbs	565
Falling Ball Impact @ 73° F	UL-746	in-lbs	900
Deflection Temperature @ 264 psi	ASTM D648	Deg. F	270
Modulus of Elasticity	ASTM D790	ksi	340
Temperature Range	-	Deg. F	-40 to 265
Flame Rating - UL	UL 94	-	5VA
Outdoor UV Exposure	UL	-	F1

Part Number	4X IP66	6P IP68	Hinged Cover	Screw Cover	Opaque Cover	Clear Cover	Mounting Feet	Mounting Flange	Stainless Steel Locking Latch	Non-Metallic Locking Latch
H6062S	✓	✓		✓	✓		✓			
H6062SC	✓	✓		✓		✓	✓			
H6062SF	✓	✓		✓	✓			✓		
H6062SCF	✓	✓		✓		✓		✓		
H6062H	✓		✓	✓	✓		✓			
H6062HC	✓		✓	✓		✓	✓			
H6062HF	✓		✓	✓	✓			✓		
H6062HCF	✓		✓	✓		✓		✓		
★ H6062HLL	✓		✓		✓		✓		✓	
★ H6062HCLL	✓		✓			✓	✓		✓	
H6062HFLL	✓		✓		✓			✓	✓	
H6062HCFLL	✓		✓			✓		✓	✓	
H6062HNL	✓		✓		✓		✓			✓
H6062HCNL	✓		✓			✓	✓			✓
H6062HFNL	✓		✓		✓			✓		✓
H6062HCFNL	✓		✓			✓		✓		✓
H6062H-6P	✓	✓	✓	✓	✓		✓			
H6062HC-6P	✓	✓	✓	✓		✓	✓			
H6062HF-6P	✓	✓	✓	✓	✓			✓		
H6062HCF-6P	✓	✓	✓	✓		✓		✓		

★ **POPULAR CONFIGURATIONS:** Most popular configurations are available for *QuickShip*. Please send requests to customerservice@integraenclosures.com to take advantage of our *QuickShip* option.



6X6X2 PREMIUM LINE

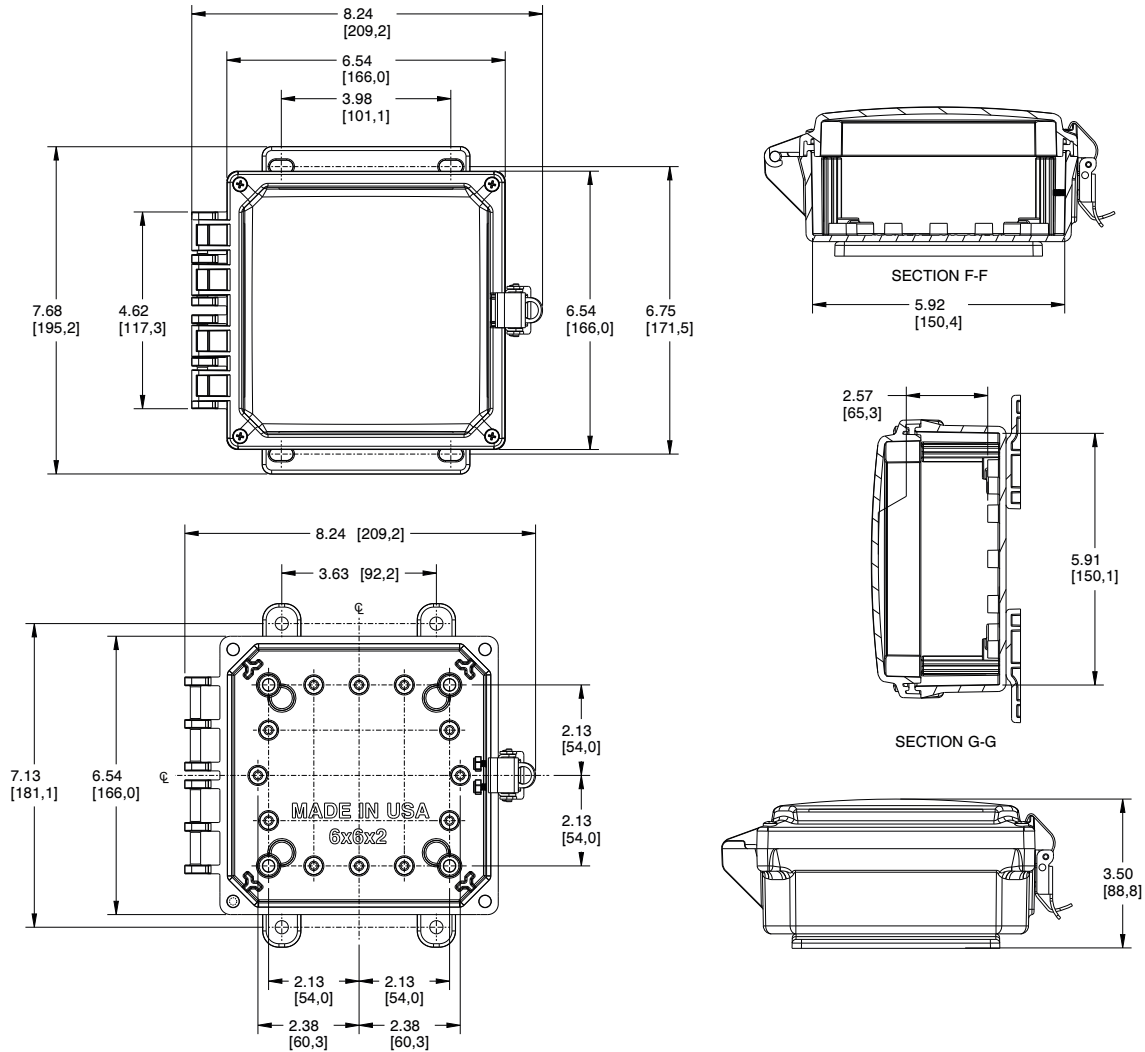

TORQUE SPECIFICATIONS:

Mounting Feet - 1/4"-20 x 0.5" SS countersunk Phillips drive screws (torque limit = 32 in lbs)









Covers/Doors - #10-32 x 0.75" SS pan Phillips drive screws (torque limit = 10 in lbs)

Panels - #10-32 x 0.375" pan Phillips drive screws (torque limit = 10-15 in lbs)

[Bracketed dimensions in mm]

Register online to download detailed drawing files at www.integraenclosures.com

Accessories for 6x6x2 (For complete accessories, see pages 77-81)

 <p>Back Panels ABP66 - Aluminum panel SBP66 - Steel panel PVCBP66 - PVC panel</p>	 <p>Aluminum Swing Out Panels ABP-66-USOPK - Complete kit ABP-66USP - Panel only USOPK - Hardware only</p>	 <p>Back Panel Adjustment Kit BPAKG - Gray, Set Screw BPAKB - Black, Set Screw UBPAKG - Gray, Thumb Screw UBPAKB - Black Thumb Screw</p>
 <p>Air Vents VENT 3 - Aluminum louvered VENT 2 - Outdoor labyrinth</p>	 <p>Steel Swing Out Panels SBP-66-USOPK - Complete kit SBP-66USP - Panel only USOPK - Hardware only</p>	 <p>Cord Grips IP68/NEMA 4X/6P rated See page 74 for more details and part numbers.</p>
 <p>Din Rail DIN 6 - 2 rails, 4 screws</p>	 <p>Pole Mounting Kit PMKG-26 - 2" pole PMKG-36 - 3" pole PMKG-46 - 4" pole PMKG-126 - 12" pole</p>	 <p>Mounting Feet & Flange Kits MFKG - Premium line feet MFKSS - Stainless steel feet MFLK6 - 6" Flange kit</p>