

## Product Summary

<b>V<sub>BR</sub> (Min)</b>	<b>I<sub>PP</sub> (Max)</b>	<b>C<sub>T</sub> (Typ)</b>
25.4V	3A	11pF

## Features

- 200W Peak Power Dissipation per Line (8/20µs Waveform)
  - Provides ESD Protection per IEC 61000-4-2 Standard: Air ±30kV, Contact ±30kV
  - 2 Channels of ESD Protection
  - Low Channel Input Capacitance
  - **Totally Lead-Free & Fully RoHS Compliant (Notes 1 & 2)**
  - **Halogen and Antimony Free. "Green" Device (Note 3)**
  - **The DESD1FLEX2SOQ is suitable for automotive applications requiring specific change control; this part is AEC-Q101 qualified, PPAP capable, and manufactured in IATF 16949 certified facilities.**
- <https://www.diodes.com/quality/product-definitions/>

## Description and Applications

This DESD1FLEX2SOQ is a next generation ESD and surge protection device packaged in a small footprint surface mount package. It is qualified to AEC-Q101, supported by a PPAP and is designed to protect two automotive FlexRay bus lines from ElectroStatic Discharge and other transients.

- FlexRay Bus Protection
- Industrial Control Network

## Mechanical Data

- Case: SOT23
- Case Material: Molded Plastic, "Green" Molding Compound. UL Flammability Classification Rating 94V-0
- Moisture Sensitivity: Level 1 per J-STD-020
- Terminals: Matte Tin Finish Annealed over Alloy 42 Leadframe (Lead Free Plating). Solderable per MIL-STD-202, Method 208(Ⓔ)
- Weight: 0.009 grams (Approximate)

### SOT23



Bottom View

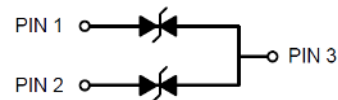

Device Schematic

## Ordering Information (Note 4)

Part Number	Compliance	Marking	Reel Size (inches)	Tape Width (mm)	Quantity per Reel
DESD1FLEX2SOQ-7	Automotive	QE7	7	8	3,000/Tape & Reel

- Notes:
1. No purposely added lead. Fully EU Directive 2002/95/EC (RoHS), 2011/65/EU (RoHS 2) & 2015/863/EU (RoHS 3) compliant.
  2. See <https://www.diodes.com/quality/lead-free/> for more information about Diodes Incorporated's definitions of Halogen- and Antimony-free, "Green" and Lead-free.
  3. Halogen- and Antimony-free "Green" products are defined as those which contain <900ppm bromine, <900ppm chlorine (<1500ppm total Br + Cl) and <1000ppm antimony compounds.
  4. For packaging details, go to our website at <https://www.diodes.com/design/support/packaging/diodes-packaging/>.

## Marking Information

### SOT23

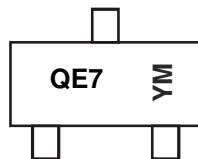

QE7 = Product Type Marking Code  
 YM = Date Code Marking  
 Y = Year (ex: H = 2020)  
 M = Month (ex: 9 = September)

### Date Code Key

Year	2016	...	2020	2021	2022	2023	2024	2025	2026	2027	2028	2029
Code	D	...	H	I	J	K	L	M	N	O	P	R
Month	Jan	Feb	Mar	Apr	May	Jun	Jul	Aug	Sep	Oct	Nov	Dec
Code	1	2	3	4	5	6	7	8	9	O	N	D

**Maximum Ratings** (@T<sub>A</sub> = +25°C, unless otherwise specified.)

Characteristic	Symbol	Value	Unit	Conditions
Peak Pulse Power Dissipation	P <sub>PP</sub>	200	W	8/20μs, per Figure 1
Peak Pulse Current	I <sub>PP</sub>	3	A	8/20μs, per Figure 1
ESD Protection – Contact Discharge	V <sub>ESD_Contact</sub>	±30	kV	IEC 61000-4-2 Standard
ESD Protection – Air Discharge	V <sub>ESD_Air</sub>	±30	kV	IEC 61000-4-2 Standard

**Thermal Characteristics**

Characteristic	Symbol	Value	Unit
Package Power Dissipation (Note 5)	P <sub>D</sub>	300	mW
Thermal Resistance, Junction to Ambient (Note 5)	R <sub>θJA</sub>	417	°C/W
Operating and Storage Temperature Range	T <sub>J</sub> , T <sub>STG</sub>	-65 to +150	°C

**Electrical Characteristics** (@T<sub>A</sub> = +25°C, unless otherwise specified.)

Characteristic	Symbol	Min	Typ	Max	Unit	Test Conditions
Reverse Standoff Voltage	V <sub>RWM</sub>	—	—	24	V	—
Channel Leakage Current (Note 6)	I <sub>RM</sub>	—	<1	50	nA	V <sub>RWM</sub> = 24V
Clamping Voltage, Positive Transients	V <sub>CL</sub>	—	—	40	V	I <sub>PP</sub> = 1A, t <sub>p</sub> = 8/20μs, Figure 1
		—	—	70		I <sub>PP</sub> = 3A, t <sub>p</sub> = 8/20μs, Figure 1
Breakdown Voltage	V <sub>BR</sub>	25.4	27.8	30.3	V	I <sub>R</sub> = 1mA
Channel Input Capacitance	C <sub>T</sub>	—	11	17	pF	V <sub>R</sub> = 0V, f = 5MHz
		—	—	17		
ABS Parasitic Capacitance Matching (Channel 1 – Channel 2)	Δ (C <sub>T_Ch1</sub> -C <sub>T_Ch2</sub> ) / C <sub>T_Max</sub> )	—	0.12	2	%	V <sub>R</sub> = 5V, f = 5MHz
	Δ (C <sub>T_Ch1</sub> -C <sub>T_Ch2</sub> )	—	0.02	0.34	pF	

- Notes:
- Device mounted on FR-4 PCB pad layout (2oz copper) as shown on Diodes Incorporated's suggested pad layout, which can be found on our website at <http://www.diodes.com/package-outlines.html>.
  - Short duration pulse test used to minimize self-heating effect.

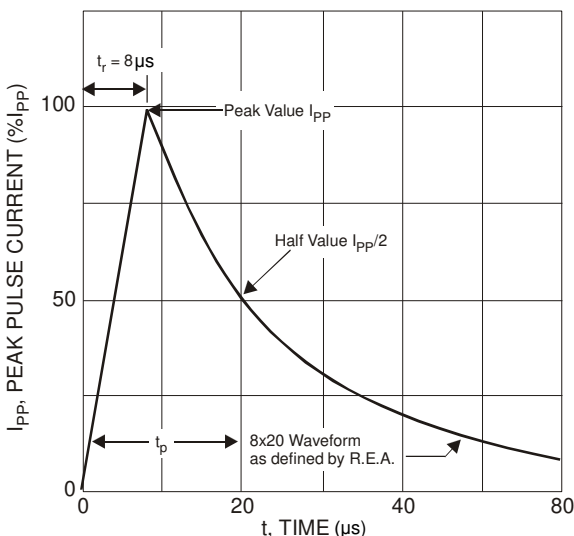
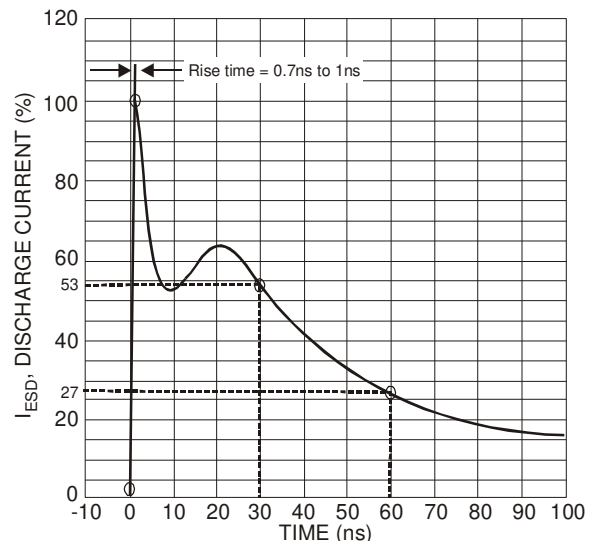

Figure 1 Pulse Waveform

 Figure 2 ESD Discharge Current Wave Form  
IEC 61000-4-2 (330Ω/150pF)

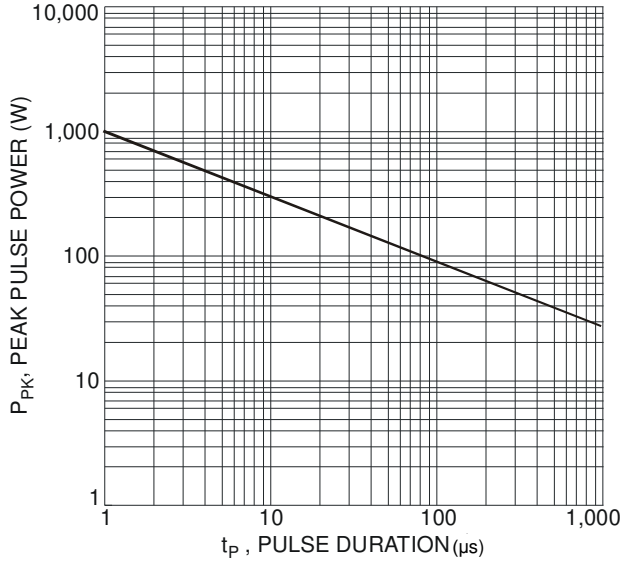

Figure 3 Peak Pulse Power vs. Pulse Duration

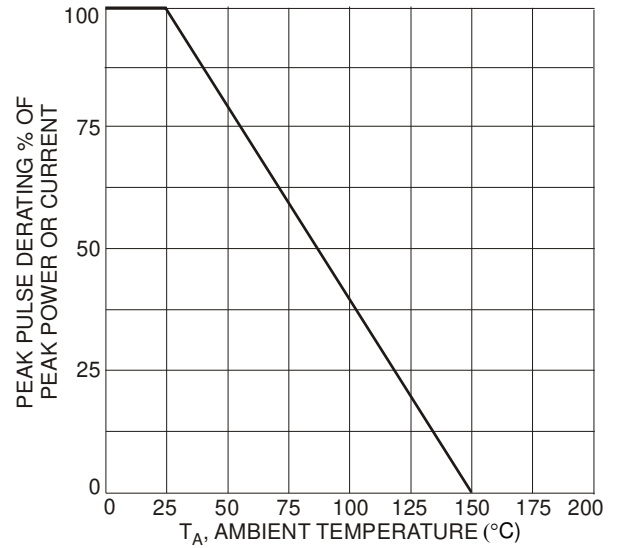

Figure 4 Pulse Derating Curve

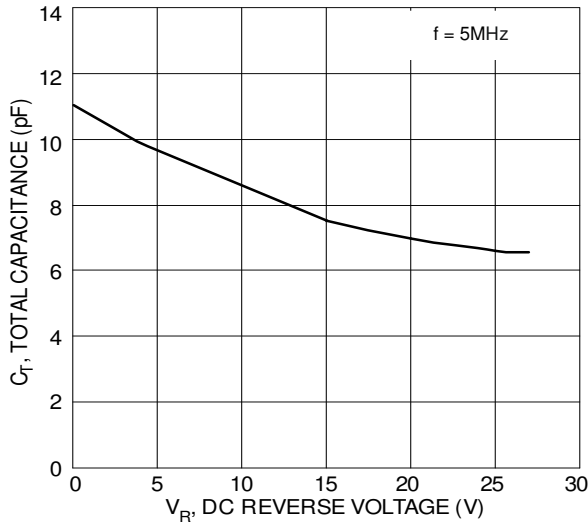

Figure 5 Total Capacitance vs. Reverse Voltage

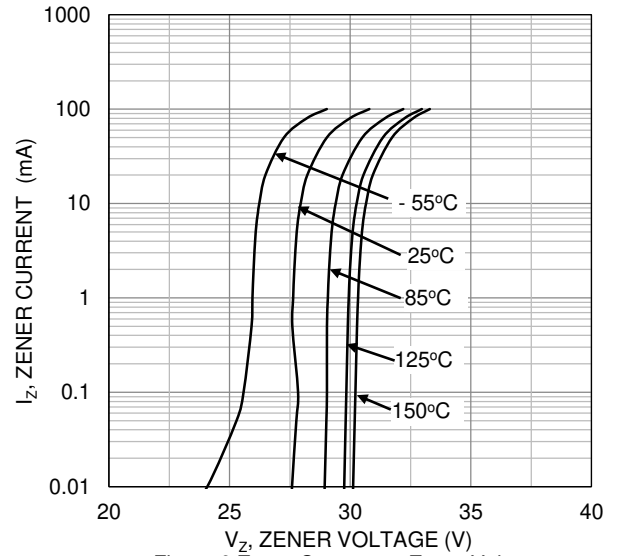

Figure 6 Zener Current vs. Zener Voltage

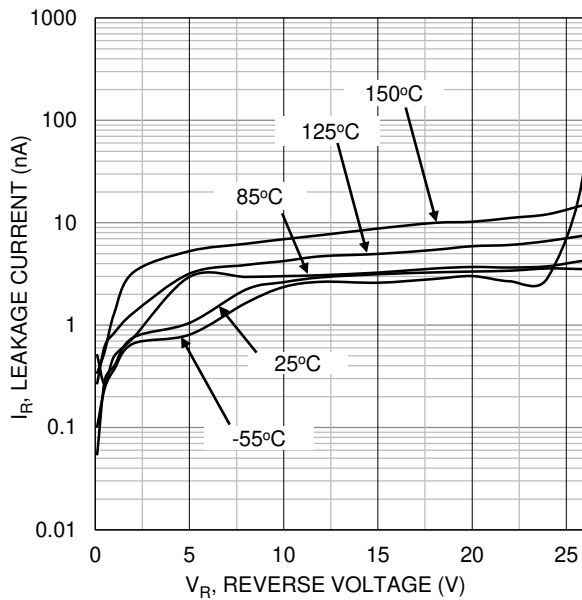
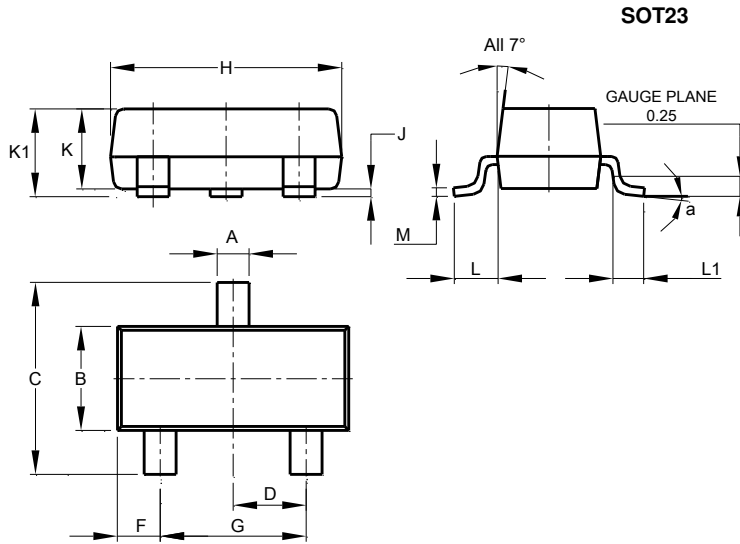

Figure 7  $I_R$  vs.  $V_R$  Temperature Characteristic

**Package Outline Dimensions**

Please see <http://www.diodes.com/package-outlines.html> for the latest version.



SOT23			
Dim	Min	Max	Typ
A	0.37	0.51	0.40
B	1.20	1.40	1.30
C	2.30	2.50	2.40
D	0.89	1.03	0.915
F	0.45	0.60	0.535
G	1.78	2.05	1.83
H	2.80	3.00	2.90
J	0.013	0.10	0.05
K	0.890	1.00	0.975
K1	0.903	1.10	1.025
L	0.45	0.61	0.55
L1	0.25	0.55	0.40
M	0.085	0.150	0.110
a	0°	8°	--
<b>All Dimensions in mm</b>			

**Suggested Pad Layout**

Please see <http://www.diodes.com/package-outlines.html> for the latest version.

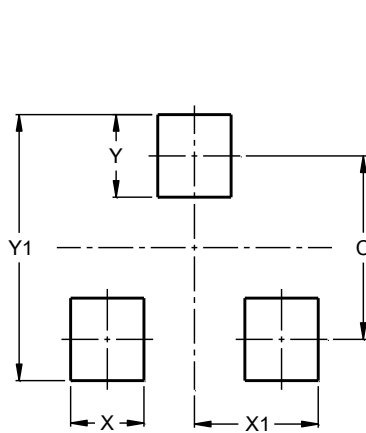

Dimensions	Value (in mm)
C	2.0
X	0.8
X1	1.35
Y	0.9
Y1	2.9

**IMPORTANT NOTICE**

DIODES INCORPORATED MAKES NO WARRANTY OF ANY KIND, EXPRESS OR IMPLIED, WITH REGARDS TO THIS DOCUMENT, INCLUDING, BUT NOT LIMITED TO, THE IMPLIED WARRANTIES OF MERCHANTABILITY AND FITNESS FOR A PARTICULAR PURPOSE (AND THEIR EQUIVALENTS UNDER THE LAWS OF ANY JURISDICTION).

Diodes Incorporated and its subsidiaries reserve the right to make modifications, enhancements, improvements, corrections or other changes without further notice to this document and any product described herein. Diodes Incorporated does not assume any liability arising out of the application or use of this document or any product described herein; neither does Diodes Incorporated convey any license under its patent or trademark rights, nor the rights of others. Any Customer or user of this document or products described herein in such applications shall assume all risks of such use and will agree to hold Diodes Incorporated and all the companies whose products are represented on Diodes Incorporated website, harmless against all damages.

Diodes Incorporated does not warrant or accept any liability whatsoever in respect of any products purchased through unauthorized sales channel. Should Customers purchase or use Diodes Incorporated products for any unintended or unauthorized application, Customers shall indemnify and hold Diodes Incorporated and its representatives harmless against all claims, damages, expenses, and attorney fees arising out of, directly or indirectly, any claim of personal injury or death associated with such unintended or unauthorized application.

Products described herein may be covered by one or more United States, international or foreign patents pending. Product names and markings noted herein may also be covered by one or more United States, international or foreign trademarks.

This document is written in English but may be translated into multiple languages for reference. Only the English version of this document is the final and determinative format released by Diodes Incorporated.

**LIFE SUPPORT**

Diodes Incorporated products are specifically not authorized for use as critical components in life support devices or systems without the express written approval of the Chief Executive Officer of Diodes Incorporated. As used herein:

A. Life support devices or systems are devices or systems which:

1. are intended to implant into the body, or
2. support or sustain life and whose failure to perform when properly used in accordance with instructions for use provided in the labeling can be reasonably expected to result in significant injury to the user.

B. A critical component is any component in a life support device or system whose failure to perform can be reasonably expected to cause the failure of the life support device or to affect its safety or effectiveness.

Customers represent that they have all necessary expertise in the safety and regulatory ramifications of their life support devices or systems, and acknowledge and agree that they are solely responsible for all legal, regulatory and safety-related requirements concerning their products and any use of Diodes Incorporated products in such safety-critical, life support devices or systems, notwithstanding any devices- or systems-related information or support that may be provided by Diodes Incorporated. Further, Customers must fully indemnify Diodes Incorporated and its representatives against any damages arising out of the use of Diodes Incorporated products in such safety-critical, life support devices or systems.

Copyright © 2020, Diodes Incorporated

**[www.diodes.com](http://www.diodes.com)**