

QMS Series

DC-DC Converters

The QMS Series of converters provide a single, isolated step-down voltage (3.3, 5 or 12 VDC nominal) from a wide-input voltage range (18 – 60 VDC). The QMS is an excellent choice in applications where multiple input voltage options are required. The designer can use a single QMS converter to cover both 24V_{in} and 48V_{in} input ranges, eliminating the need to specify multiple circuit packs to handle each input range. This is particularly useful in wireless base station applications where the power plants tend to vary and could provide nominal 24 or 48 V input.

The QMS converters are highly efficient over the entire wide-input voltage range, cost-effective, and offer a low profile, industry-standard quarter-brick footprint. The standard feature set includes remote on/off, remote output voltage sensing, industry-standard output trim, input undervoltage lockout, and overtemperature shutdown with hysteresis.

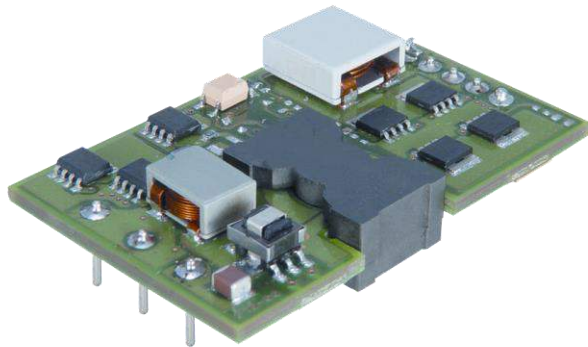

RoHS
Compliant

Key Features & Benefits

- RoHS lead free solder and lead solder exempted products are available
- Ultra-wide input range: 18 to 60 VDC
- Cost-effective, single board construction
- High efficiency
- Low profile
- Input-to-output isolation: 1500 VDC
- Basic Insulation
- Start-up into high capacitive load
- Low conducted and radiated EMI
- Output overcurrent protection
- Output overvoltage protection
- Input undervoltage lockout
- Overtemperature protection
- Approved to UL 60950-1/ CAN/CSA-C22.2 No. 60950-1, and TUV approved to EN 60950-1, IEC 60950-1



bel POWER
SOLUTIONS &
PROTECTION

a bel group

belpowersolutions.com

1. MODEL SELECTION

MODEL	INPUT VOLTAGE VDC	INPUT CURRENT, MAX ADC ¹	OUTPUT VOLTAGE VDC	OUTPUT RATED CURRENT, IRATED ADC	OUTPUT RIPPLE/NOISE, MVP-P ²	TYPICAL EFFICIENCY @ IRATED & 36VIN
QMS25DE	18 - 60	6.0	3.3	25	50	90%
QMS14DG	18 - 60	4.3	5.0	14	50	92%
QMS07DH	18 - 60	5.0	12.0	6.75	120	92%

This product is intended for integration into end-use equipment. All the required procedures for CE marking of end-use equipment should be followed.

Model numbers highlighted in yellow are not recommended for new designs.

2. ABSOLUTE MAXIMUM RATINGS

Stresses in excess of the absolute maximum ratings may cause performance degradation, adversely effect long-term reliability, and cause permanent damage to the converter.

PARAMETER	CONDITIONS/DESCRIPTION	MIN	MAX	UNITS
Input Voltage	Continuous	0	60	VDC
	Transient Withstand (100 ms)		100	VDC
Operating Temperature	Hot Spot Monitor Location ³ (T _c)	-40	125	°C
	Ambient	-40	85	°C
Storage Temperature	Ambient	-40	125	°C
ON/OFF Control Voltage	Referenced to -Vin	-0.7	20	VDC
Output Power ⁴	QMS25DE		82.5	W
	QMS14DG		70	W
	QMS07DH		81	W

3. ENVIRONMENTAL AND MECHANICAL SPECIFICATIONS

PARAMETER	CONDITIONS/DESCRIPTION	MIN	NOM	MAX	UNITS
Operating Humidity	Relative Humidity, Non-cond.			95	%
Storage Humidity	Relative Humidity, Non-cond.			95	%
Shock	(Half-sinewave, 6 ms), 3 axes	50			g
Sinusoidal Vibration	GR-63-CORE, Section 5.4.2	1			g
Weight			1.2/35		Oz/g
Water Washing	Standard process		Yes		
MTBF (Calculated)	Per Telcordia SR-332 Issue 1, (method 1, case 2, GB, 400C)		1,750		kHrs
Dimensions	(Overall)		2.28 (57.9) x 1.45 (36.8) x 0.43 (11)		In. (mm)
Markings & Labeling	Includes P/N, Logo, Date Code, Country of Manufacture				

¹ @ V_{IN} minimum.

² Nominal, (DC to 500 kHz)

³ See temperature probe location T_c, Figure 36. [Ref.V09 case]

⁴ With appropriate power derating, see Figures 37 – 42.

4. INSULATION SPECIFICATIONS

All specifications apply over specified input voltage, output load, and temperature range, unless otherwise noted.

PARAMETER	CONDITIONS/DESCRIPTION	MIN	NOM	MAX	UNITS
Insulation Safety Rating			Basic		
Isolation Voltage	Input to Output	1500			VDC
Isolation Resistance	Input to Output	10			M Ω
Isolation Capacitance	Input to Output		4700		pF

5. EMI & SAFETY REGULATORY COMPLIANCE

SAFETY AGENCY	STANDARD APPROVED TO:	MARKING
UL	UL60950-1 / CSA C22.2 No. 60950-1-03	cURus
TUV product service	TUV EN60950-1/A11:2004	TUV PS Baurt mark
CB report	IEC60950-1:2001	N/A
Declaration of Conformity	DIR 73/23/EEC Low Voltage Directive	CE
Conducted Emissions ⁵	(with external EMI filter)	CISPR 22 class A

6. INPUT SPECIFICATIONS

All specifications apply over specified input voltage, output load, and temperature range, unless otherwise noted.

PARAMETER	CONDITIONS/DESCRIPTION	MIN	NOM	MAX	UNITS
Input Voltage	Continuous	18		60	VDC
Turn-On Input Voltage (UVLO) ⁶	Ramping Up	16	17	18	VDC
Turn-Off Input Voltage ⁶	Ramping Down	13	15	16.5	VDC
Turn-Off Hysteresis		2			VDC
Input Reflected Ripple Current	@ IRATED, 12 μ H source inductance BW=20MHz ⁷		10	72	mAP-P
No-load Input Current	18VDC < Vin < 60VDCc		90	150	mA
No-load Power Dissipation	Vin = 36VDC			5	W
Disabled Input Current	18VDC < Vin < 60VDC		25	50	mA
Input Capacitance (internal)				1.4	μ F
Minimum Input Capacitance (external)	(ESR < 0.7 Ω)	100			μ F
Inrush Transient				0.1	A2s

⁵ See figures 43, 44, 45

⁶ See Figure 2

⁷ Vin = 36V_{in}, see Figure 1 and 47

7. OUTPUT SPECIFICATIONS

All specifications apply over specified input voltage, output load, and @ 40 OC ambient temperature, unless otherwise noted.

7.1 QMS25DE: 3.3V / 25A

PARAMETER	CONDITIONS/DESCRIPTION	MIN	NOM	MAX	UNITS	
Output Voltage (Set-point)	Vin = 36V, Io = 25A	3.25	3.30	3.35	VDC	
Line Regulation	Vi = 18V to 60V, Io = 50% Io.max			10	mV	
				0.3	%	
Load Regulation	Vin = 36V, Io.min to Io.max			25	mV	
				0.75	%	
Temperature Coefficient	-40 °C < TAMB < +85 °C			0.02	%/°C	
Total Error Band	(Line, Load, Temperature, Ripple, Life)	3.12		3.48	VDC	
				+/- 5.5	%	
Output Power ⁸	w/ proper thermal derating			82.5	W	
Output Current ⁸	w/ proper thermal derating	0		25	A	
Output Current Limit Threshold	Vin = 36 V, Vo < 90% Vonom	125		150	%Iomax	
Output Ripple ⁹	Over line and load, (DC to 20 MHz)		-40 °C < TAMB < +85 °C			
			50	100	mVP-P	
			1.5	3.0	%	
			17	35	mVRMS	
Dynamic Regulation ¹⁰	75-100-75% load step change, to 1% error band, Co=0 μF			+/-165	+/-330	mV
Peak Deviation	Slew = 1.0A/μs >>>			500	1,000	μs
Settling Time						
Peak Deviation	Slew = 0.1A/μs >>>			+/-165	+/-330	mV
Settling Time				500	1,000	μs
Efficiency ¹¹ (TAMB=40°C)	Vin NOM, IO = IRATED			90		%
Turn-on Overshoot ¹²	Overall input voltage, load, and temperature conditions			5	10	%Vout
Turn-On Time $f(VIN)$ ¹²	Time from Vin=UVLO to 90% of VoutNOM	2	10	150		ms
Turn-On Time $f(On/Off)$ ¹³	Time from enable to 90% of VoutNOM		50	250		ms
Rise Time ¹²	From 10 to 90% of VoutNOM		1	2		ms
Admissible Load Capacitance ¹⁴	Irated, Nom Vin	330		8,220		μF
Switching Frequency			300			kHz

⁸ see Figures 37 and 40

⁹ see Figure 18 for ripple waveform and Figure 46 for measurement method

¹⁰ see Figures 12 and 15

¹¹ see Figure 3

¹² see Figure 6

¹³ see Figure 9

¹⁴ A minimum 330 μF (AVX, TPSD337K006R0045) is recommended for operation over full load, line and temperature range

7.2 QMS14DG: 5V / 14A

PARAMETER	CONDITIONS/DESCRIPTION	MIN	NOM	MAX	UNITS	
Output Voltage (Set-point)	Vi = 36 V, Io =14 A	4.925	5.0	5.075	VDC	
Line Regulation	Vi =18 V to 60 V, Io =50% Io,max				15	mV
					0.3	%
Load Regulation	Vi =36V, Io,min to Io,max				25	mV
					0.5	%
Temperature Coefficient	-40 °C < TAMB < +85 °C				0.02	%/°C
Total Error Band	(Line, Load, Temperature, Ripple, Life)				4.76	VDC
					+/- 4.8	%
Output Power ¹⁵	w/ proper thermal derating				70	W
Output Current ¹⁵	w/ proper thermal derating				14	A
Output Current Limit Threshold	Vin = 36 V, Vo < 90%Vonom				120	%Iomax
					50	mVP-P
Output Ripple ¹⁶	Over line and load, (DC to 20 MHz)	-40 °C < TAMB < +85 °C			1.0	%
					17	42
Dynamic Regulation ¹⁷ Peak Deviation	75-100-75% load step change, to 1% error band, Co=0 μF Slew = 1.0A/μs >>>				+/- 250	mV
					500	+/-500 μs
Settling Time Peak Deviation	Slew = 0.1A/μs >>>				+/- 250	mV
					500	+/-500 μs
Efficiency ¹⁸ (TAMB=40°C)	VinNOM, IO = IRATED				92	%
Turn-on Overshoot ¹⁹	Overall input voltage, load, and temperature conditions				5	10 %Vout
Turn-On Time $f_{(VIN)}$ ¹⁹	Time from Vin=UVLO to 90% of VoutNOM	2	10	150	ms	
Turn-On Time $f_{(On/Off)}$ ²⁰	Time from enable to 90% of VoutNOM				50	250 ms
Rise Time ¹⁹	From 10 to 90% of VoutNOM				3	6 ms
Admissible Load Capacitance ²¹	IRATED, Nom Vin	220				4,600 μF
Switching Frequency					330	kHz

¹⁵ see Figures 38 and 41

¹⁶ see Figure 19 for ripple waveform and Figure 46 for measurement method.

¹⁷ see Figures 13 and 16

¹⁸ see Figure 4

¹⁹ see Figure 7

²⁰ see Figure 10

²¹ A minimum 220 μF (AVX, TPSD227K010R0050) is recommended for operation over full load, line and temperature range.

7.3 QMS07DH: 12V / 6.75A

PARAMETER	CONDITIONS/DESCRIPTION	MIN	NOM	MAX	UNITS
Output Voltage (Set-point)	$V_i = 36\text{ V}$, $I_o = 6.75\text{ A}$	11.82	12.0	12.18	VDC
Line Regulation	$V_i = 18\text{ V}$ to 60 V , $I_o = 50\% I_{o,max}$			60	mV
				0.5	%
Load Regulation	$V_i = 36\text{ V}$, $I_{o,min}$ to $I_{o,max}$			60	mV
				0.5	%
Temperature Coefficient	$-40\text{ °C} < T_{AMB} < +85\text{ °C}$			0.02	%/°C
Total Error Band	(Line, Load, Temperature, Ripple, Life)	11.44		12.56	VDC
				+/-	%
				4.7	%
Output Power ²²	w/ proper thermal derating			81	W
Output Current ²²	w/ proper thermal derating	0		6.75	A
Output Current Limit Threshold	$V_{in} = 36\text{ V}$, $V_o < 90\% V_{onom}$	130		170	% $I_{o,max}$
Output Ripple ²³	Over line and load, $-40\text{ °C} < T_{AMB} < +85\text{ °C}$ (DC to 20 MHz)		120	200	mVP-P
			1.0	1.67	%
			42	70	mVRMS
Dynamic Regulation ²⁴	75-100-75% load step change, to 1% error band, $C_o = 0\text{ }\mu\text{F}$ Slew = $1.0\text{ A}/\mu\text{s} \gg$		+/-	+/-	mV
Peak Deviation			600	1,200	mV
Settling Time			500	1,000	μs
Peak Deviation	Slew = $0.1\text{ A}/\mu\text{s} \gg$		+/-	+/-	mV
Settling Time			600	1,200	μs
			500	1,000	μs
Efficiency ²⁵ ($T_{AMB} = 40\text{ °C}$)	$V_{in,NOM}$, $I_O = I_{RATED}$		92		%
Turn-on Overshoot ²⁶	Overall input voltage, load, and temperature conditions		5	10	% V_{out}
Turn-On Time $f_{(VIN)}$ ²⁶	Time from $V_{in} = UVLO$ to 90% of $V_{out,NOM}$	2	50	150	ms
Turn-On Time $f_{(On/Off)}$ ²⁷	Time from enable to 90% of $V_{out,NOM}$		50	250	ms
Rise Time ²⁶	From 10 to 90% of $V_{out,NOM}$		4	8	ms
Admissible Load Capacitance ²⁸	Irated, Nom V_{in}	68		2,200	μF
Switching Frequency			330		kHz

²² see Figures 39 and 42

²³ see Figure 20 for ripple waveform and Figure 46 for measurement method.

²⁴ see Figures 14 and 17

²⁵ see Figure 5

²⁶ see Figure 8

²⁷ see Figure 11

²⁸ A minimum 68 μF (AVX, TPSD686K020R0070) is recommended for operation over full load, line and temperature range.

8. PROTECTIONS SPECIFICATIONS

All specifications apply over specified input voltage, output load, and @ 40 OC ambient temperature, unless otherwise noted.

PARAMETER	CONDITIONS/DESCRIPTION	MIN	NOM	MAX	UNITS
Overcurrent Protection					
Type	Non-latching – auto-recovery, hiccup type.				
Threshold					
QMS25DE	Vin = Vin NOM	31.2		37.5	ADC
QMS14DG		16.8		22.4	ADC
QMS07DH		8.8		11.5	ADC
Short Circuit²⁹					
QMS25DE	Hiccup Mode		17	30	ARMS
QMS14DG			17	22	ARMS
QMS07DH			12	15	ARMS
Overvoltage Protection³⁰					
Type	Clamp, non-latching, hiccup mode. Independent control loop, auto-reset.				
Threshold		115		140	%Vo
Overtemperature Protection					
Type	Non-latching, auto-recovery				
Threshold	Temperature node: TC ³¹		135		°C

9. FEATURE SPECIFICATIONS

All specifications apply over specified input voltage, output load, and @ 40 OC ambient temperature, unless otherwise noted.

PARAMETER	CONDITIONS/DESCRIPTION	MIN	NOM	MAX	UNITS
On/Off³²					
Negative Logic (-N suffix)	(On/Off signal is low – converter is ON)				
	Converter ON	-0.7		0.8	VDC
On/Off (pin 2)	Sink current			1.0	mADC
(Primary side ref. to -Vin)	Converter OFF	3.5		20	VDC
	Open circuit voltage	7		18	VDC
Positive Logic (-P suffix)	(On/Off signal is low – converter is OFF)				
	Converter ON	3.5		20	VDC
On/Off (pin 2)	Open Circuit Voltage	7		18	VDC
(Primary side ref. to -Vin)	Converter OFF	-0.7		0.8	VDC
	Sink current			1.0	mADC
Remote Sense					
Remote Sense Headroom				10	%Vo
Output Voltage Trim³³					
Trim Up				10	%Vo
Trim Down		-10			%Vo

²⁹ Refer to Figures 21, 22, 23.

³⁰ Refer to Figures 24 – 29

³¹ Refer to Figure 36.

³² See Figure 30.

³³ The output voltage of the units can be increased to a maximum of 10%. This is comprised of a combination of the remote-sense and trim adjustment. Do not exceed 10% of V_{nom} between +V_{out} and -V_{out} terminals. Also refer to "Output Voltage Adjust" section and Figures 31 – 35 for clarification.)

10. PERFORMANCE CHARACTERISTIC

10.1 REFLECTED RIPPLE CURRENT

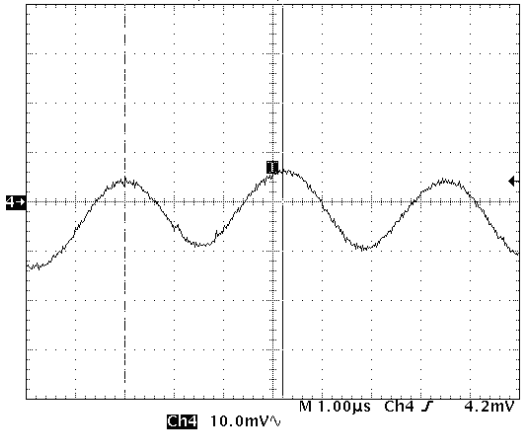

Figure 1. QMS25DE, Input Reflected Riple Current (typ.)

Conditions: Output current = 25 ADC (82.5 W).
 Input voltage = 36 VDC.
 Waveform: InputRRC < 10 mAP-P (measured)
 Scale: 5mA/10mV or 5mA/division.

10.3 UNDERVOLTAGE LOCKOUT CHARACTERISTICS (TYP)

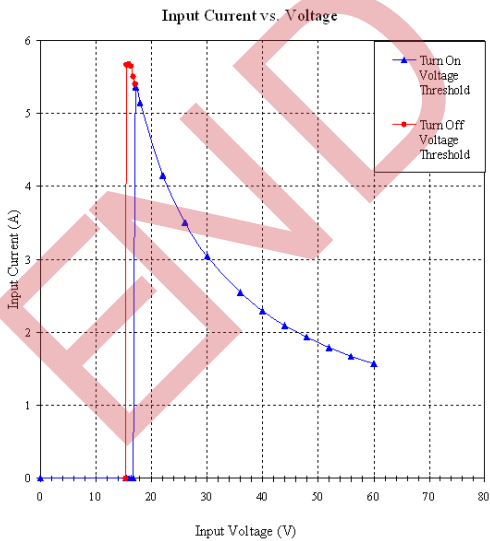

Figure 2. UVLO Input Characteristics

10.2 EFFICIENCY

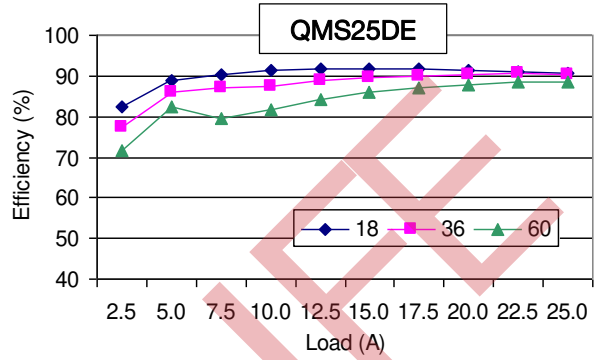

Figure 3. Efficiency, η (Line & load)

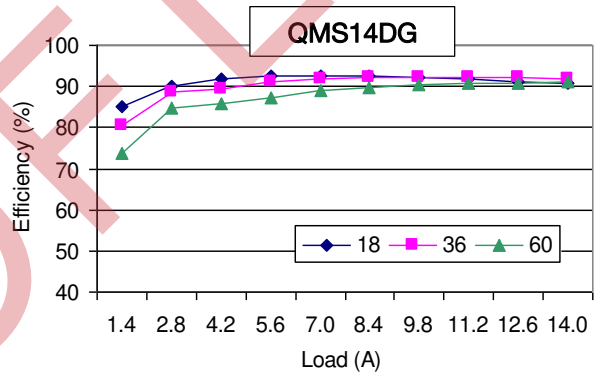

Figure 4. Efficiency, η (Line & load)

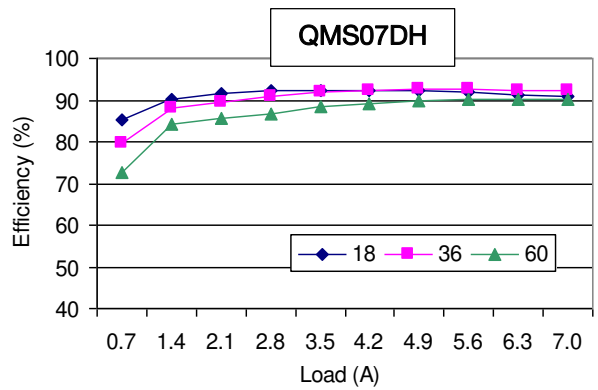

Figure 5. Efficiency, η (Line & load)

Vo Turn-on Characteristics, $f(V_{IN})$

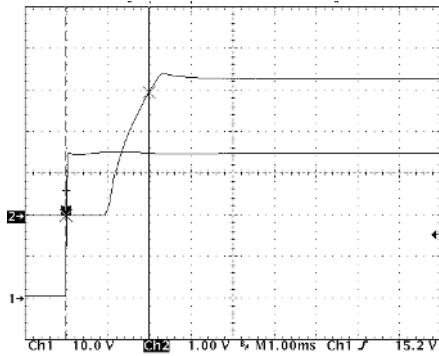

Figure 6. QMS25DE, Turn-On @ Power-up (typ)

Conditions: V_{in} max., $C_{ext} = 0 \mu F$ Output current: 25 ADC
 Channel 1 - Input voltage = 36 VDC Scale : 10V/div., 1ms/div.
 Channel 2 - V_{out} , TRISE = 1 ms Scale : 1V/div.

Vo Turn-on Characteristics, $f(ON/OFF)$

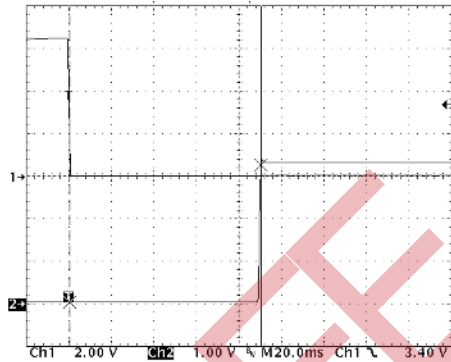

Figure 1. QMS25DE, Turn-On via On/Off Ctrl (typ)

Conditions: $V_{in} = 36$ VDC, $C_{ext} = 0 \mu F$ Output current: 25 ADC
 Channel 1 - On/Off signal Scale : 2V/div.
 Channel 2 - Output voltage Amplitude = 1V/div.
 Time base = 20 ms/div. Delay time = 90ms (typ.)

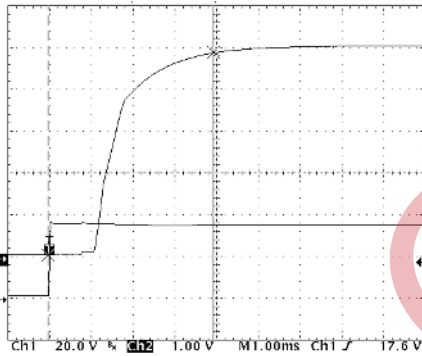

Figure 2. QMS14DG, Turn-On @ Power-up (typ)

Conditions: V_{in} max., $C_{ext} = 0 \mu F$ Output current: 14 ADC
 Channel 1 - Input voltage = 36 VDC Scale : 20V/div., 1ms/div.
 Channel 2 - V_{out} , TRISE = 3 ms Scale : 1V/div.

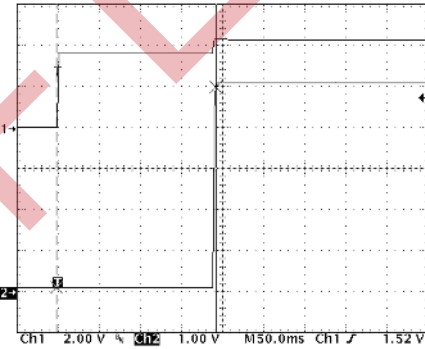

Figure 3. QMS14DG, Turn-On via On/Off Ctrl (typ)

Conditions: $V_{in} = 36$ VDC, $C_{ext} = 0 \mu F$ Output current: 14 ADC
 Channel 1 - On/Off signal Scale : 2V/div.
 Channel 2 - Output voltage Amplitude = 1V/div.
 Time base = 50 ms/div. Delay time = 200 ms (typ.)

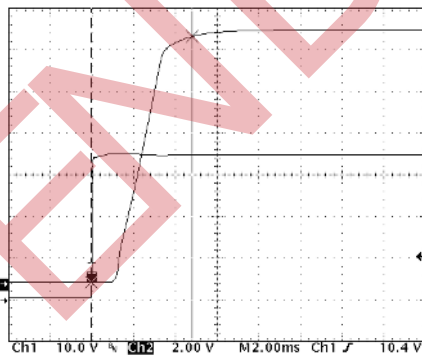

Figure 4. QMS07DH, Turn-On @ Power-up (typ)

Conditions: V_{in} max., $C_{ext} = 0 \mu F$ Output current: 6.75 ADC
 Channel 1 - Input voltage = 36 VDC Scale : 10V/div., 2ms/div.
 Channel 2 - V_{out} , TRISE = 4 ms Scale : 2V/div.

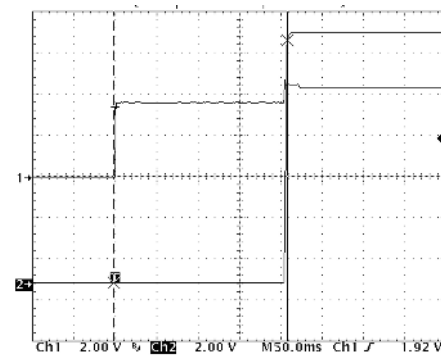

Figure 5. QMS07DH, Turn-On via On/Off Ctrl (typ)

Conditions: $V_{in} = 36$ VDC, $C_{ext} = 0 \mu F$ Output current: 6.75 ADC
 Channel 1 - On/Off signal Scale : 2V/div.
 Channel 2 - Output voltage Amplitude = 2V/div.
 Time base = 50 ms/div. Delay time = 200 ms (typ.)



Asia-Pacific
 +86 755 298 85888

Europe, Middle East
 +353 61 225 977

North America
 +1 408 785 5200

10.4 DYNAMIC LOAD RESPONSE

Conditions: $V_{in} = 36 \text{ VDC}$, $C_{ext} = 0 \mu\text{F}$

Scale: 500 mV/div, 200 μs /div.

Load: (25% load Δ) with slew rate: 1.0A/ μs

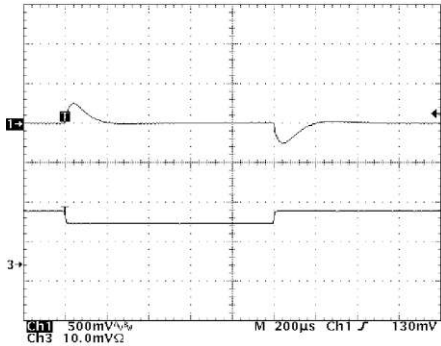

Figure 6. QMS25DE Load Response (typ)

Channel 1 - Voltage deviation: ~ 250 mVP (measured)
Channel 3 - Load switched from 18.75 A to 25 A

Conditions: $V_{in} = 36 \text{ VDC}$, $C_{ext} = 0 \mu\text{F}$

Scale: 500 mV/div, 200 μs /div.

Load: (25% load Δ) with slew rate: 1.0A/ μs

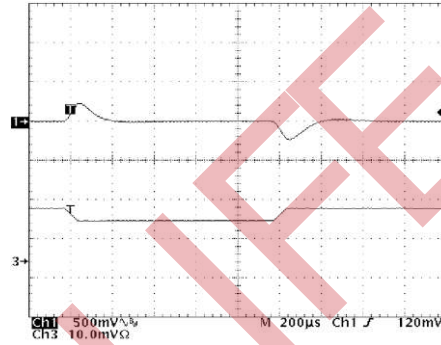

Figure 7. QMS25DE, Load Response (typ)

Channel 1 - Voltage deviation: ~ 250 mVP (measured)
Channel 3 - Load switched from 18.75 A to 25 A

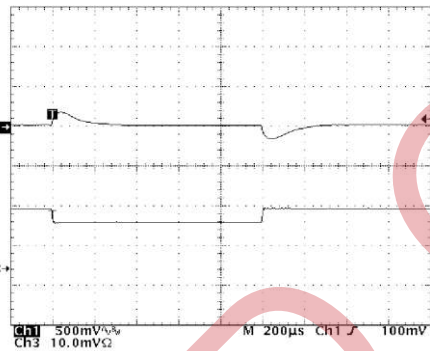

Figure 8. QMS14DG, Load Response (typ)

Channel 1 - Voltage deviation: ~ 175 mVP (measured)
Channel 3 - Load switched from 10.5 A to 14 A

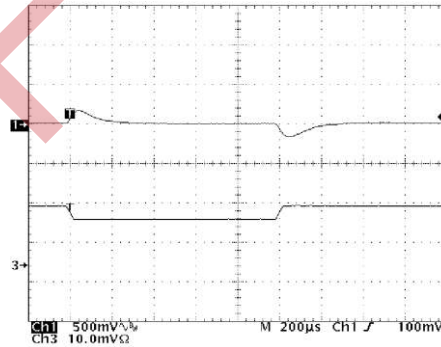

Figure 9. QMS14DG, Load Response (typ)

Channel 1 - Voltage deviation: ~ 200 mVP (measured)
Channel 3 - Load switched from 10.5 A to 14 A

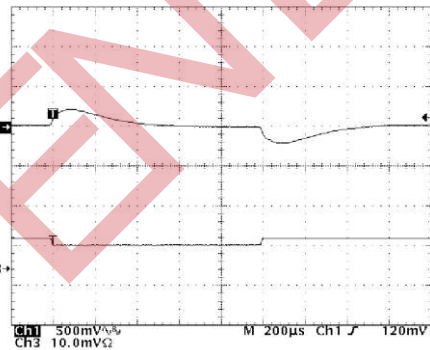

Figure 10. QMS07DH, Load Response (typ)

Channel 1 - Voltage deviation: ~ 225 mVP (measured)
Channel 3 - Load switched from 5.0 A to 6.75 A

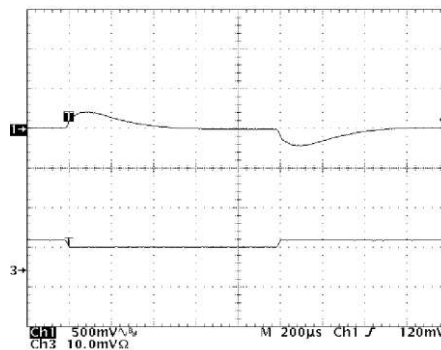

Figure 11. QMS07DH, Load Response (typ)

Channel 1 - Voltage deviation: ~ 225 mVP (measured)
Channel 3 - Load switched from 5.0 A to 6.75 A

10.5 OUTPUT RIPPLE AND NOISE (TYP, $-40^{\circ}\text{C} < T_{\text{AMB}} < +85^{\circ}\text{C}$)

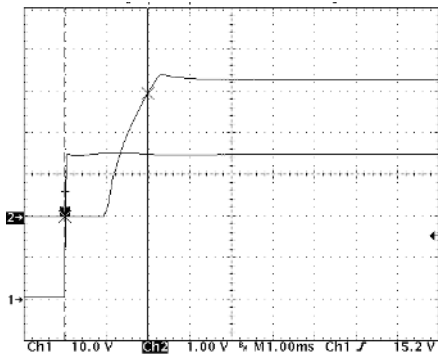

Figure 12. QMS25DE Output Ripple & Noise (typ.)

Conditions: $V_{\text{in}} = 60\text{ V}$ and $I_{\text{out}} = 25\text{ A}$.
Channel 1 - V_{o} , (AC coupled), $\sim 50\text{ mV}_{\text{P-P}}$ (measured)

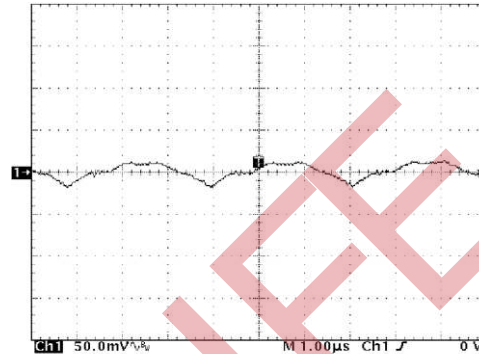

Figure 13. QMS14 Output Ripple & Noise (typ.)

Conditions: $V_{\text{in}} = 60\text{ V}$ and $I_{\text{out}} = 14\text{ A}$.
Channel 1 - V_{o} , (AC coupled), $\sim 35\text{ mV}_{\text{P-P}}$ (measured)

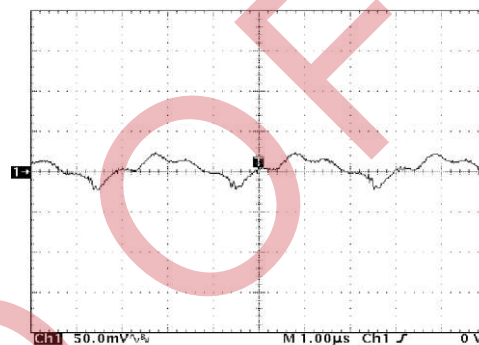

Figure 14. QMS07 Output Ripple & Noise (typ.)

Conditions: $V_{\text{in}} = 60\text{ V}$ and $I_{\text{out}} = 6.75\text{ A}$.
Channel 1 - V_{o} , (AC coupled), $\sim 50\text{ mV}_{\text{P-P}}$ (measured)

10.6 OVERCURRENT PROTECTION

When the output is loaded above the maximum output current rating, the voltage of the converter will reduce to maintain the output power at a safe level. In the case of a high overload or short circuit condition where the output voltage is pulled below 50% of $V_{\text{o-nom}}$, the unit will enter into a "Hiccup" mode of operation. Under this condition, the converter will attempt to restart, typically every 250 ms, until the overload has cleared. Because of very low duty cycle, the RMS value of output current is kept low. Once the output current is reduced to within its rated range, the converter automatically exits the hiccup mode and continues normal operation.

QMS25DE

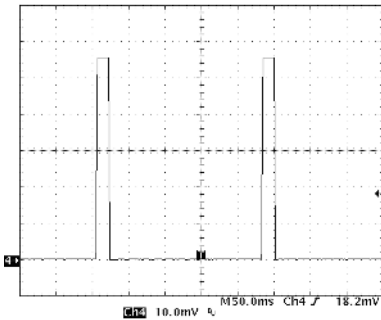

Figure 15, Short Circuit Behavior (typ.)

Condition: $V_{in}=60VDC$
 $ISC < 30 ARMS$
 Scale: 10 Amp/div.

QMS14DG

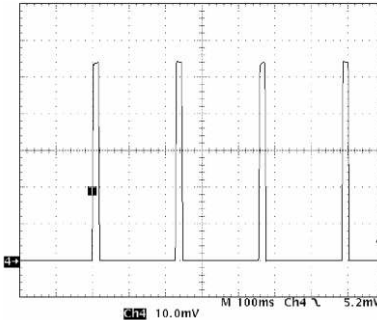

Figure 16, Short Circuit Behavior (typ.)

Condition: $V_{in}=60VDC$
 $ISC < 22 ARMS$
 Scale: 10 Amp/div.

QMS07DH

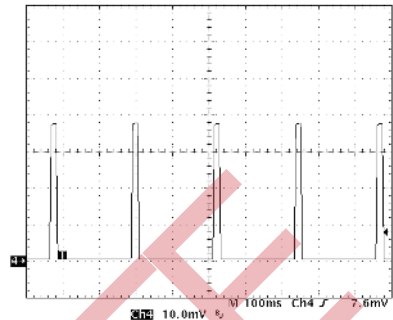

Figure 17, Short Circuit Behavior (typ.)

Condition: $V_{in}=60VDC$
 $ISC < 15 ARMS$
 Scale: 10 Amp/div.

10.7 PRE-BIAS CONDITIONS

The QMS converters will start-up into a pre-bias voltage of 50% V_{oNOM} without damage.

10.8 OVERVOLTAGE PROTECTION

The output overvoltage protection consists of a separate control loop, independent of the primary control loop. This secondary control loop has a higher voltage set point than the primary loop. In a fault condition, the converter enters a "hiccup" mode of operation, and ensures that the output voltage does not exceed $V_{ovp\ max}$.

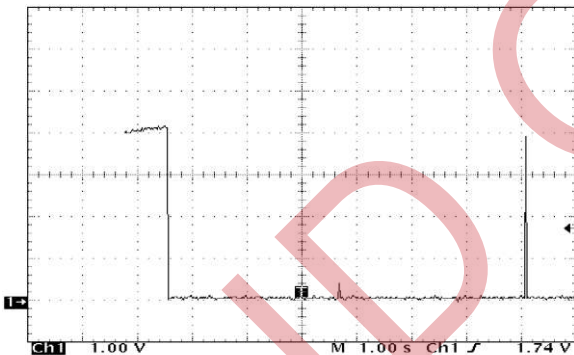

Figure 18. QMS25DE, Induced OVP Behavior (typ.)

Conditions: $V_{in} = 36 V$, $I_{out} = 75\% \text{ load}$.
 Channel 1- V_o , Scale: 1 V/div., 1 sec.div.

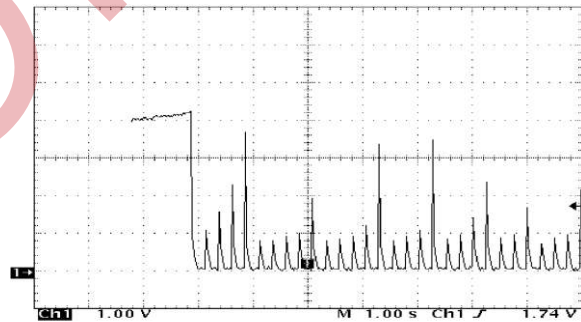

Figure 19. QMS25DE, Induced OVP Behavior (typ.)

Conditions: $V_{in} = 36 V$, $I_{out} = \text{minimum load}$.
 Channel 1- V_o , Scale: 1 V/div., 1 sec.div.

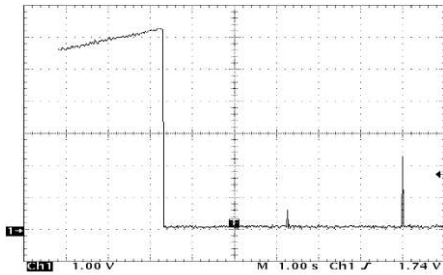

Figure 20. QMS14DG, Induced OVP Behavior (typ.)

Conditions: $V_{in} = 36\text{ V}$, $I_{out} = 75\%$ load.
Channel 1- V_o , Scale: 1 V/div., 1 sec.div.

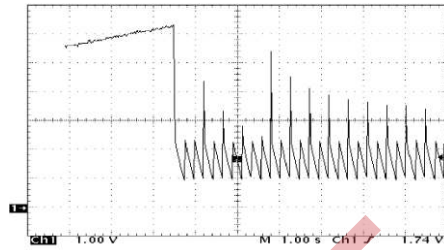

Figure 21. QMS14DG, Induced OVP Behavior (typ.)

Conditions: $V_{in} = 36\text{ V}$, $I_{out} = \text{minimum load}$.
Channel 1- V_o , Scale: 1 V/div., 1 sec.div.

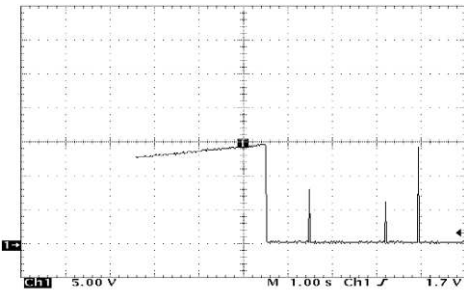

Figure 22. QMS07DH, Induced OVP Behavior (typ.)

Conditions: $V_{in} = 36\text{ V}$, $I_{out} = 75\%$ load.
Channel 1- V_o , Scale: 1 V/div., 1 sec.div.

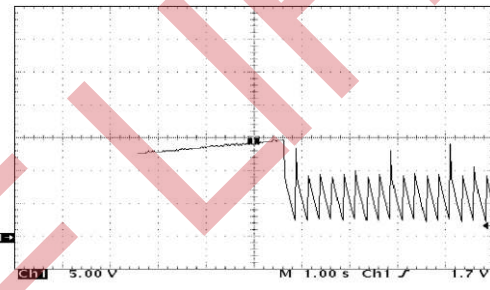

Figure 23. QMS07DH, Induced OVP Behavior (typ.)

Conditions: $V_{in} = 36\text{ V}$, $I_{out} = \text{minimum load}$.
Channel 1- V_o , Scale: 1 V/div., 1 sec.div.

11. TYPICAL APPLICATION

11.1 INPUT AND OUTPUT IMPEDANCE

The QMS-Series has been designed for stability without external capacitance when used in low inductance input and output circuits. In many applications, the inductance associated with the distribution of the power source to the input of the power converter can negatively affect a converter's stability. The addition of a 33 μF electrolytic capacitor with an ESR < 100 m Ω , across the input helps to ensure stability of the converter. This capacitor should be of suitably high quality and rated for effective use at low temperatures as needed.

Refer to the "Inrush Current Control Application Note" on www.power-one.com for suggestions on how to limit the magnitude of the inrush current.

Additionally, see the EMC section further below in this datasheet for discussion for other external component which may be required for reduction of conducted emissions.

The QMS can support high amounts of output capacitance. Refer to "Output Specification" tables for details.

11.2 INRUSH CURRENT

Refer to the "Inrush Current Control Application Note": (http://www.power-one.com/technical/articles/dc-dc_1-app.pdf) for suggestions on how to limit the magnitude of the inrush current.

12. FEATURES DESCRIPTION

12.1 ON/OFF CONTROL

(-x) "no suffix" model

With the positive logic model, when the ON/OFF pin is pulled low, the output is turned off and the unit draws less than 25 mA of input current. If the ON/OFF pin is not used, it can be left floating

(-N) suffix model

With negative logic, when the ON/OFF pin is pulled low, the unit is turned on. If the ON/OFF pin is not used, it can be connected to the -Vin pin.

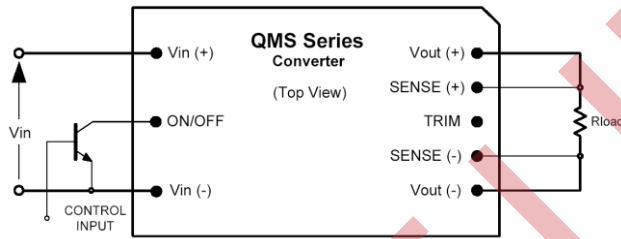

Figure 30. On/Off Control

(Common to -x & -N models)

The ON/OFF pin in the QMS converter functions as a normal soft shutdown. The ON/OFF pin is pulled up internally, so no external voltage source is required or recommended. The user should avoid connecting a resistor between the ON/OFF pin and the +Vin pin. The ON/OFF pin is internally referenced to the -Vin pin. An open collector switch is recommended to control the voltage between these two points.

The controlling signal must not be referenced ahead of EMI filtering, or remotely from the unit. Optical coupling the control signal and locating the opto-coupler directly at the converter, is recommended for trouble-free operation.

13. OUTPUT VOLTAGE ADJUSTMENT (TRIM)

The industry-standard trim feature allows the user to adjust the output voltage from its nominal value. This can be used to accommodate production margin testing.

Output voltage adjustment is accomplished by connecting an external resistor between the Trim pin and to either the +VOUT or -VOUT pins. That below defines the two versions as well as trim equations used to determine a trim resistor value for a certain trim voltage.

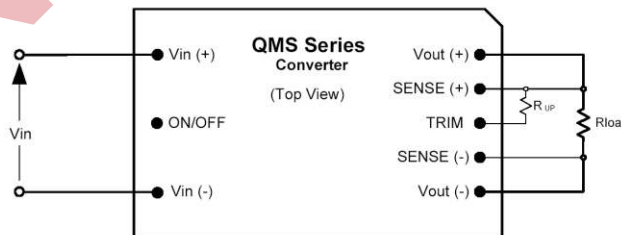

Figure 31. QMS Trim Schematic

With an external resistor (R_{UP}) connected between the Trim pin and +VOUT pin, the output voltage set-point (V_o) increases. The following equation determines the required external resistor value to obtain an adjusted output voltage:

$$R_{UP} = \left(\frac{5.11 \cdot V_{out} \cdot (100 + \Delta V\%)}{1.225 \Delta V\%} - \frac{511}{\Delta V\%} - 10.22 \right) \cdot K\Omega$$

Where Δ% is the percentage change from Vo_{NOM}.

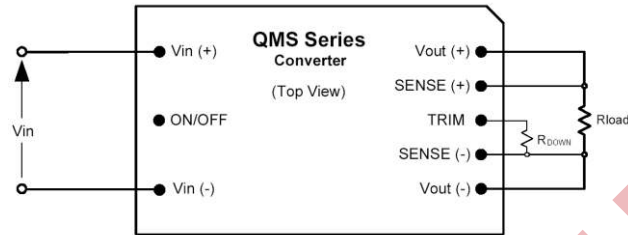

Figure 32. QMS Trim Schematic

With an external resistor (RDOWN) between the Trim pin and –VOUT pin the output voltage set-point (Vo) decreases. The following equation determines the required external resistor value to obtain an adjusted output voltage:

$$R_{DOWN} = \left(\frac{511}{\Delta V_o\%} - 10.22 \right) \cdot K\Omega$$

QMS25DE Trim Values:

Vo INCREASE			Vo DECREASE		
ΔVo%	R-UP (KΩ)	New Vo (VDC)	ΔVo%	R-DOWN (KΩ)	New Vo (VDC)
1	869	3.33	1	501	3.27
2	436	3.37	2	245	3.23
3	292	3.40	3	160	3.20
4	220	3.43	4	118	3.17
5	177	3.47	5	92	3.14
6	148	3.50	6	75	3.10
7	127	3.53	7	63	3.07
8	112	3.56	8	54	3.04
9	100	3.60	9	47	3.00
10	90	3.63	10	41	2.97

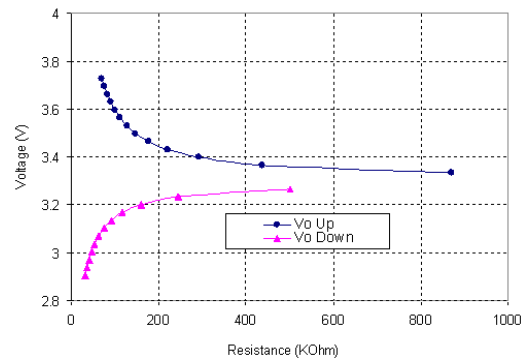

Figure 24. QMS25DE Trim Characteristics

QMS14DG Trim Values

Vo INCREASE			Vo DECREASE		
$\Delta Vo\%$	R-UP (K Ω)	New Vo (VDC)	$\Delta Vo\%$	R-DOWN (K Ω)	New Vo (VDC)
1	1585	5.05	1	501	4.95
2	798	5.10	2	245	4.90
3	536	5.15	3	160	4.85
4	404	5.20	4	118	4.80
5	326	5.25	5	92	4.75
6	273	5.30	6	75	4.70
7	236	5.35	7	63	4.65
8	207	5.40	8	54	4.60
9	186	5.45	9	47	4.55
10	168	5.50	10	41	4.50

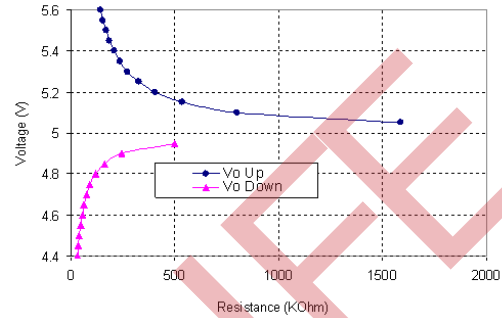

Figure 25. QMS14DG Trim Characteristics

QMS07DH Trim Values

Vo INCREASE			Vo DECREASE		
$\Delta Vo\%$	R-UP (K Ω)	New Vo (VDC)	$\Delta Vo\%$	R-DOWN (K Ω)	New Vo (VDC)
1	4535	12.12	1	501	11.88
2	2287	12.24	2	245	11.76
3	1538	12.36	3	160	11.64
4	1164	12.48	4	118	11.52
5	939	12.60	5	92	11.40
6	789	12.72	6	75	11.28
7	682	12.84	7	63	11.16
8	602	12.96	8	54	11.04
9	539	13.08	9	47	10.92
10	489	13.20	10	41	10.80

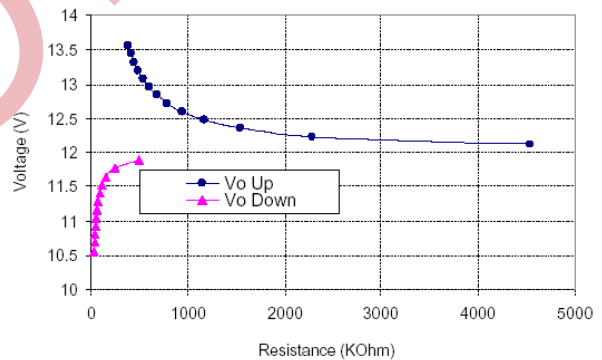

Figure 26. QMS07DH Trim Characteristics

Notes:

1. When the output voltage is trimmed up, the output power from the converter must not exceed its maximum rating. The power is determined by measuring the output voltage on the output pins, and multiplying it by the output current.
2. In order to avoid creating apparent load regulation degradation, it is important that the trim resistors be connected directly to the remote sense pins, and not to the load or to traces going to the load.
3. The output voltage increase can be accomplished either by the trim or by the remote sense or by the combination of both. In any case, the absolute maximum output voltage increase shall not exceed the limits defined in the *Features Specification* section above.
4. Either Rup or Rdown should be used to adjust the output voltage according to the equations above. If both Rup and Rdown are used simultaneously, they will form a resistive divider and the equations above will not apply.

14. THERMAL CONSIDERATIONS

QMS converters are designed for both natural and forced convection cooling. To achieve long term reliability, the recommended power derating curves below, were established by comparing measured junction and hot spot temperatures against those allowed per Power-One’s component derating guidelines

The graphs in Figures 37 thru 42 show the maximum recommended output current of each QMS converter at various ambient temperatures under both natural and forced convection cooling (longitudinal airflow direction, from pin 1 to pin 3). Vin for both 24 VDC and 48 VDC conditions are shown.

15. THERMAL MEASUREMENTS

Measurements requiring airflow were made in Power-One’s vertical wind tunnel equipment using both Infrared (IR) thermography as well as the traditional thermocouple method. The converter was soldered to a test board consisting of a 0.060” thick printed wiring board (PWB) with four layers. The top and bottom layers were not metalized. The two inner layers, comprised of two-ounce copper, were used to provide traces for connectivity to the converter. The lack of metalization on the outer layers as well as the limited thermal connection ensured that heat transfer from the converter to the PWB was minimized. This provides a worst-case but consistent scenario for thermal derating purposes.

With the converter installed into the host application, customer verification that all components are at or below their safe operating temperatures may be performed similarly. However, for a more simplified testing method, monitoring the converter’s designated thermal reference point (TC) will yield effective results.

The recommended location of the measuring thermocouple is shown below. This reference point should be maintained at < 125 OC.

It is recommended to use a 32AWG to 40AWG thermocouple wire probe on the location identified below; labeled Tc

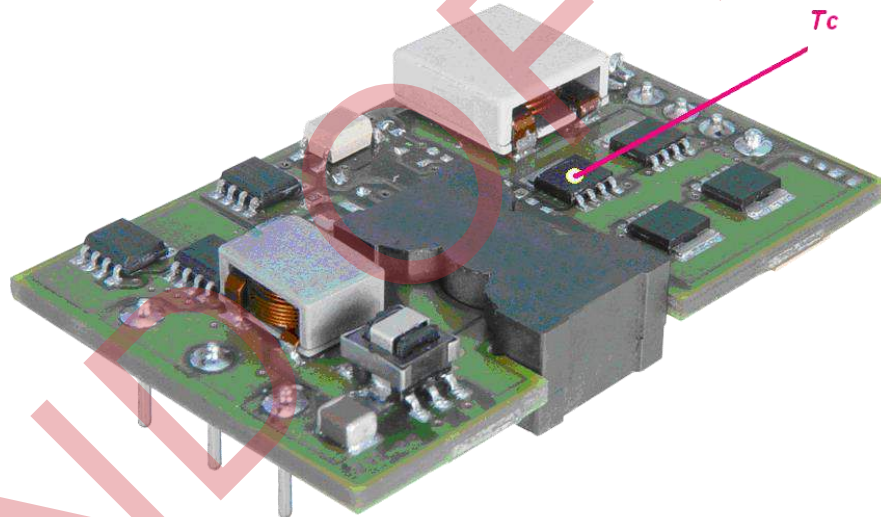

Figure 27. Thermal Reference, TC.

(QMS25DE shown)

16. POWER DERATING (VIN, TA, AIRFLOW)

Direction of airflow: from -VIN (Pin 1) to +VIN (Pin 3)

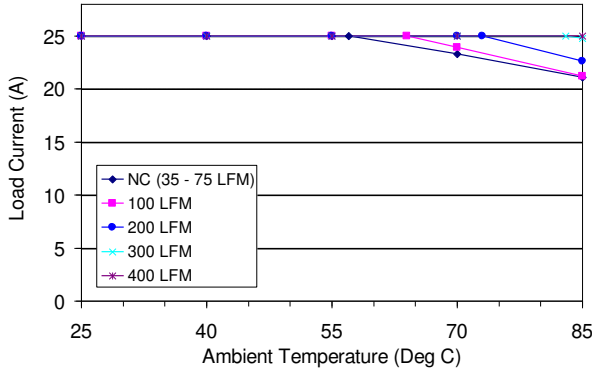

Figure 28. QMS25DE, Vin = 24 VDC

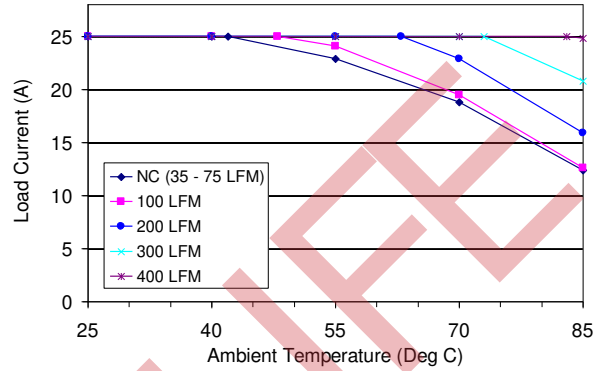

Figure 29. QMS25DE, Vin = 48 VDC

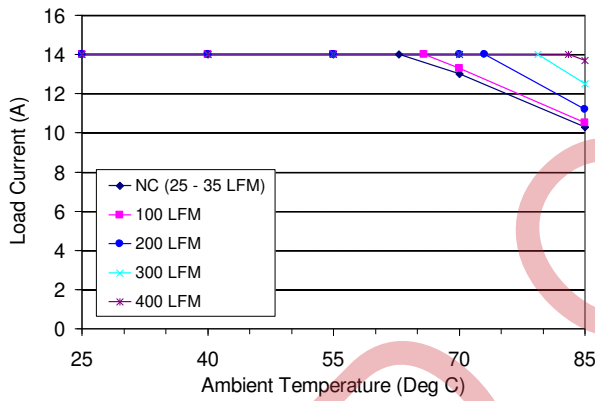

Figure 30. QMS14DG, Vin = 24 VDC

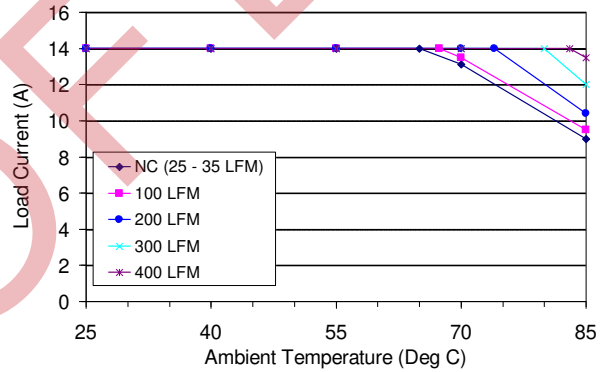

Figure 31. QMS14DG, Vin = 48 VDC

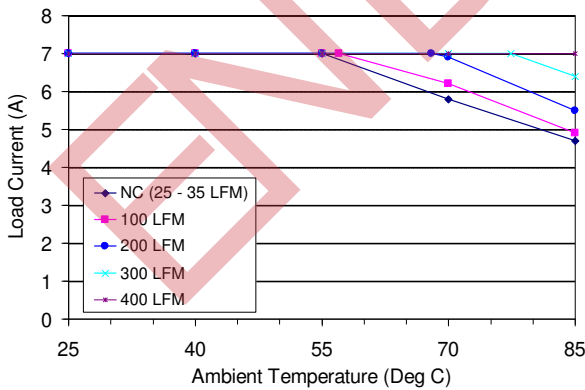

Figure 32. QMS07DH, Vin = 24 VDC

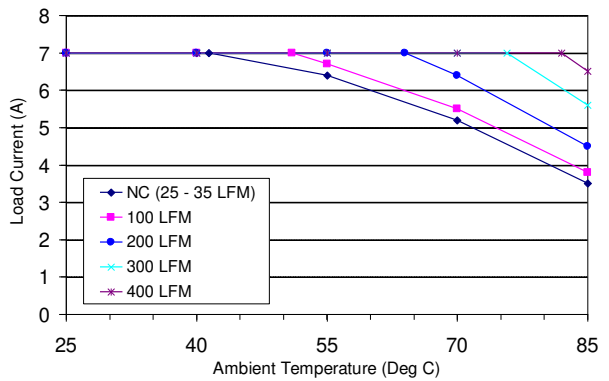

Figure 33. QMS07DH, Vin = 48 VDC

17. SAFETY CONSIDERATIONS

The QMS converters feature 1500 VDC isolation from the input-to-output. The input-to-output resistance is greater than 10 MΩ. These converters are provided with Basic insulation between input and output circuits according to all IEC60950 based standards. Nevertheless, if the system using the converter needs to receive safety agency approval, certain rules must be followed in the design of the system. In particular, all of the creepage and clearance requirements of the end-use safety requirements must be observed. These documents include UL60950 - CSA60950-00 and EN60950, although other or additional requirements may be needed for specific applications. The QMS converter has no internal fuse. The external fuse must be provided to protect the system from catastrophic failure. Refer to the “Input Fuse Selection for DC/DC converters” application note on www.power-one.com for proper selection of the input fuse. Both input traces and the chassis ground trace (if applicable) must be capable of conducting a current of 1.5 times the value of the fuse without opening. The fuse must not be placed in the grounded input line, if any.

In order for the output of the QMS converter to be considered as SELV (Safety Extra Low Voltage) or TNV-1, according to all IEC60950 based standards, one of the following requirements must be met in the system design:

- If the voltage source feeding the module is SELV or TNV-2, the output of the converter may be grounded or ungrounded.
- If the voltage source feeding the module is ELV, the output of the converter may be considered SELV only if the output is grounded per the requirements of the standard.
- If the voltage source feeding the module is a Hazardous Voltage Secondary Circuit, the voltage source feeding the module must be provided with at least Basic insulation between the source to the converter and any hazardous voltages. The entire system, including the QMS converter, must pass a dielectric withstand test for Reinforced insulation. Design of this type of system requires expert engineering and understanding of the overall safety requirements and should be performed by qualified personnel.

Note: This information is provided for guidance only and the user is responsible for any design considerations regarding safety.

18. CONDUCTED EMI

The following conducted EMI filter configuration and component values are offered as a guideline to assist in designing an effective filter solution in the actual application. Many factors can affect overall EMI performance; such as layout, wire routing and load characteristics, among others. As a result, the final circuit configuration and component values may require adjustment.

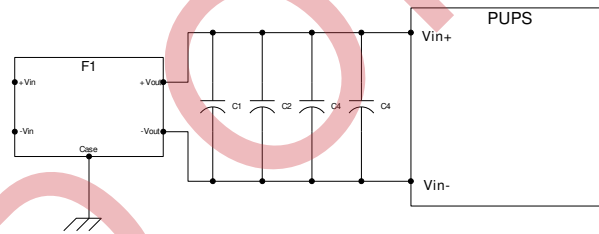

Figure 34. EMI Filter Configuration

REF. DES	DESCRIPTION	MANUFACTURER
C1, C2	1 μF @100V MLC	AVX or Equivalent
C3, C4	100 μF @ 100V Alum. Electrolytic	Panasonic NGH Series or Equiv.
F1	FC100V10A Input Filter Module	Power-One

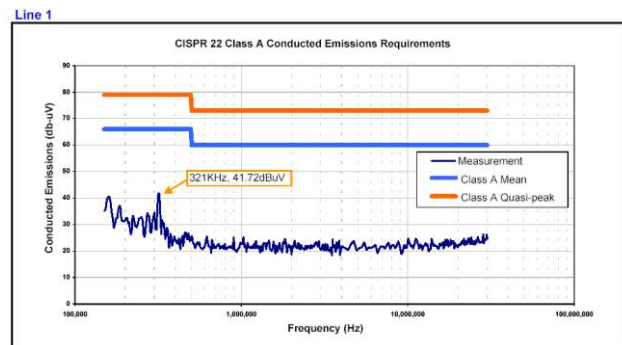

Figure 35. Conducted EMI Scan of the QMS25DE

(w/ Input Filter Components Designated in Table Above.)
 Test conditions: Vin = 36 VDC, Io = 100% rated (82.5 W)
 Test Specification: (CISPR-22) NE55022 Class A (Peak Detect)

Alternate - Minimum Margin Filter Design

REF. DES	DESCRIPTION	MANUFACTURER
C1 – C4	Not Used	N/A
F1	FC100V10A Input Filter Module	Power-One

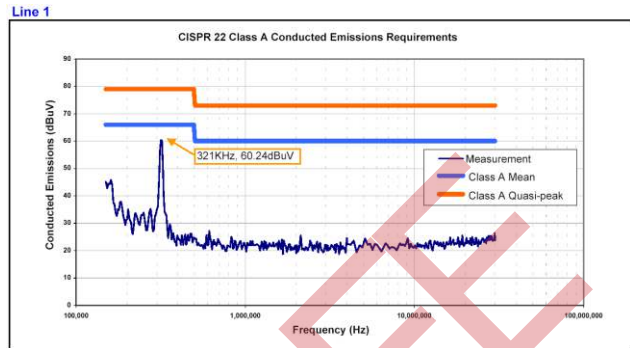

Figure 36. Conducted EMI Scan of the QMS25DE

(w/ Input Filter Components Designated in Table Above.)

Test conditions: Vin = 36 VDC, Io = 100% rated (82.5 W)

Test Specification: (CISPR-22) NE55022 Class A (Peak Detect)

19. OTHER MEASUREMENT METHODS

To improve the accuracy and repeatability of ripple and noise measurements, Power-One utilizes the test setups shown in Figure 37 & 47 below.

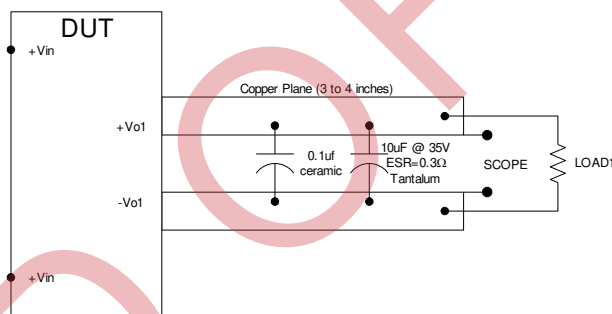

Figure 37. Output Ripple and Noise Set-up.

A BNC connector is used for measurements to eliminate noise pickup associated with long ground leads of conventional scope probes. The load is located 3" to 4" away from the converter.

For output decoupling, we recommend using a 10 μF low ESR tantalum (AVX TPSC106M025R0500 is used in Power-One test setup) and a 0.1 μF ceramic capacitor. Note that the capacitors do not substitute for filtering required by the load.

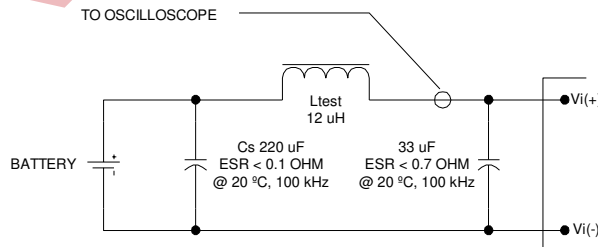
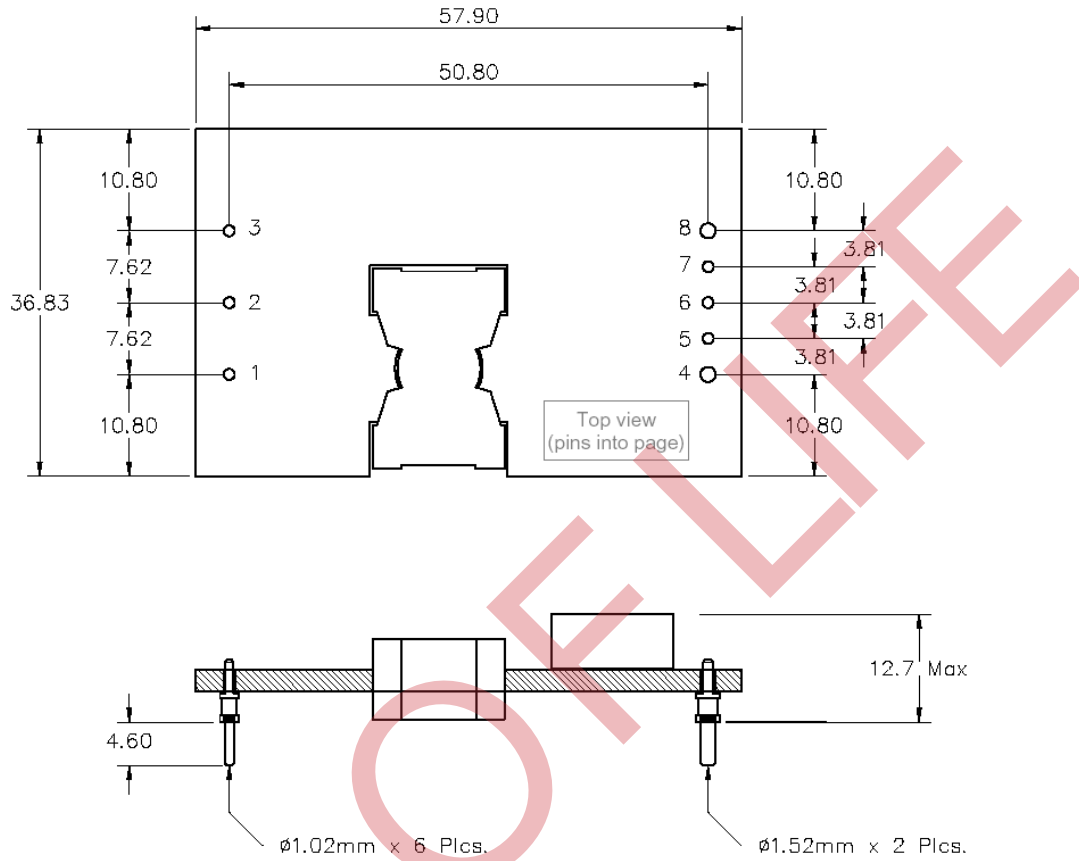

Figure 38. Input Reflected Ripple Current Set-up

Note: Measure input reflected-ripple current with a simulated inductance (Ltest) of 12 μH. Capacitor CS offsets possible battery impedance. Measure current as shown above.

20. MECHANICAL DRAWING



MECHANICAL TOLERANCES & FINISHES:

	Millimeters	Inches
<i>General Dimensions</i>	X.X = ±0.5	X.XX = ±0.020
	X.XX ±0.50	X.XXX = ±0.020
	Distance from tallest converter component to host board	0.25 MIN
<i>Pins</i>		
Diameter	±0.05	±0.002
Length		
4.6mm [0.180"] (suffix -n/a)	±0.5	±.020
3.68mm [0.145"] (suffix -7)	±0.5	±.020
2.79mm [0.110"] (suffix -8)	±0.5	±.020
	Location	Dimension
Pin Shoulder	Pins 1-3 & 5-7	1.80mm dia.
	Pins 4 & 8	2.1mm dia.
Material & Finish	Copper with Tin/Lead over Nickel	

PIN	FUNCTION
1	-Vin
2	On/Off
3	+Vin
4	-Vout
5	-Sense
6	Trim
7	+Sense
8	+Vout

21. ORDERING INFORMATION

Example: QMS at 12 V with negative logic, and 3.68mm [0.145"] length pins = QMS07DH-N7

SERIES	# OUTPUTS	Io	Vin RANGE	Vout	-	OPTIONS (Suffixes)	
						On/Off Logic	Pin Length
QM	S	25	D	E, G, H	-	None, N	None, 7, 8
Negative Logic (-N suffix) On/Off (pin 2) (Primary side ref. to -Vin)	S = Single Output	Abc	18 to 60 V _{DC}	E = 3.3 G = 5.0 H = 12.0	-	None = Pos. N = Nef	None (Standard) = 4.6mm [0.18"] 7 = 7.68mm [0.145"] 8 = 2.79mm [0.110"]

RoHS Ordering Information

OPTIONS	SUFFIXES TO ADD TO PART NUMBER
RoHS lead solder exemption	No RoHS character required
RoHS compliant for all 6 substances	Add "G" as the character of the part number



For more information on these products consult: tech.support@psbel.com

NUCLEAR AND MEDICAL APPLICATIONS - Products are not designed or intended for use as critical components in life support systems, equipment used in hazardous environments, or nuclear control systems.

TECHNICAL REVISIONS - The appearance of products, including safety agency certifications pictured on labels, may change depending on the date manufactured. Specifications are subject to change without notice.



tech.support@psbel.com
belpowersolutions.com