

RECOMMENDED P.C.B LAYOUT

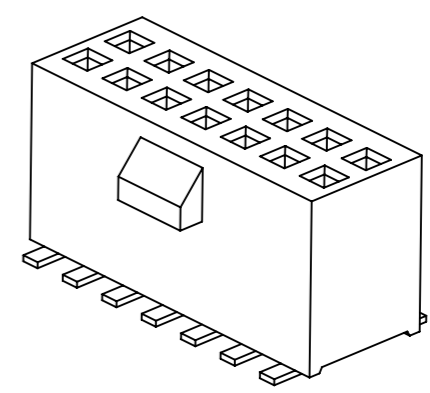
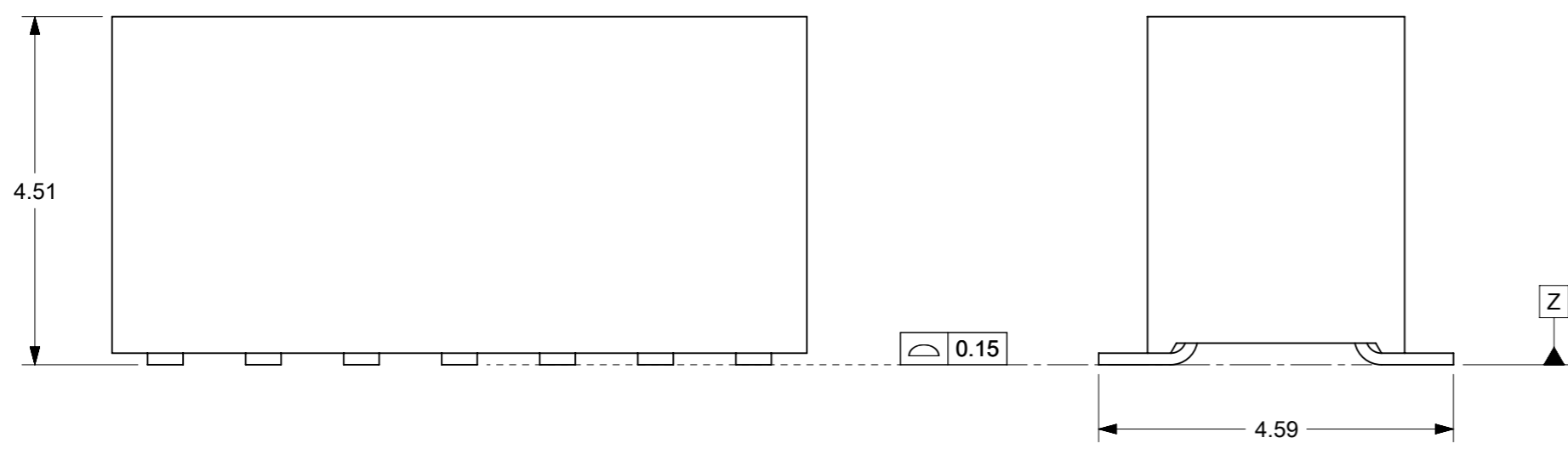

- NOTE:**
1. MATERIAL: HOUSING: LCP GLASS FILLED, COLOR: BLACK
TERMINAL: PHOSPHOR BRONZE WITH 0.25µm GOLD AT CONTACT AREA OVER 1.27µm NICKEL UNDERPLATE.
 2. PIN PUSHOUT FORCE: 0.4KG MIN
 3. THE ABOVE 14 CKT SHOWN IS FOR ILLUSTRATION ONLY.
 4. PARTS TO BE PACKED IN TUBE.
 5. PRODUCT SPECIFICATION PS-87933-001 APPLIES.
 6. THIS PART IS TO BE MATED WITH 87932, 87933 OR 87934 SERIES
 7. PACKAGING SPECIFICATION REFER TO PK-89990-576

P/N PACKED IN TUBE	CKT SIZE	KAPTON TAPE	DIMENSION	
			A	B
78120-0813	08	NO	5.19	3.81
78120-2013	20	NO	12.81	11.43
78120-3013	30	NO	19.16	17.78
78120-8013	80	NO	50.91	49.53
78120-0013	100	NO	63.61	62.23

THIS DRAWING CONTAINS INFORMATION THAT IS PROPRIETARY TO MOLEX ELECTRONIC TECHNOLOGIES, LLC AND SHOULD NOT BE USED WITHOUT WRITTEN PERMISSION

DIMENSION UNITS		SCALE		CURRENT REV DESC: REMASTERED & BTB DISTANCE UPDATE		molex	
MM	NTS						
GENERAL TOLERANCES (UNLESS SPECIFIED)				EC NO: 664214		1.27MM PITCH, DUAL ROW RECEPTACLE, SMT	
		MM	INCH	DRWN: KSUTAR 2021/05/07		PRODUCT CUSTOMER DRAWING	
4 PLACES ±		±	±	CHK'D: ABABUPS 2021/05/18		DOCUMENT NUMBER	
3 PLACES ±		±	±	APPR: MRAMAKRISHNA 2021/05/18		DOC TYPE DOC PART REVISION	
2 PLACES ±		0.15	±	INITIAL REVISION:		SD-78120-007	
1 PLACE ±		±	±	DRWN: CWLAM 2007/02/16		PSD 001 A4	
0 PLACES ±		±	±	APPR: KWLEE 2007/02/27		MATERIAL NUMBER CUSTOMER	
ANGULAR TOL ± 1.0°				DRAWING		SHEET NUMBER	
DRAFT WHERE APPLICABLE MUST REMAIN WITHIN DIMENSIONS		THIRD ANGLE PROJECTION		SERIES		GENERAL MARKET	
				A3-SIZE 78120		1 OF 2	

BOARD TO BOARD (BTB) DISTANCE

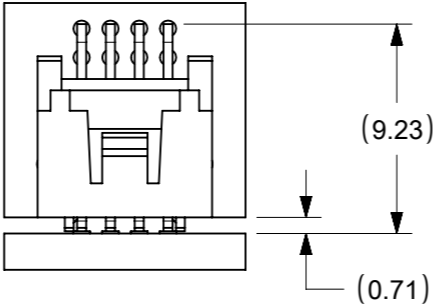
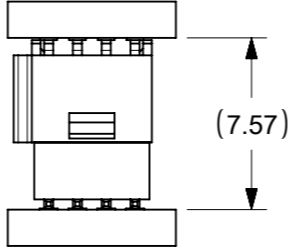
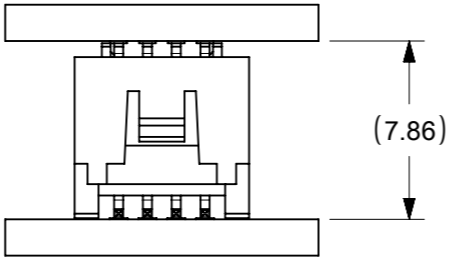
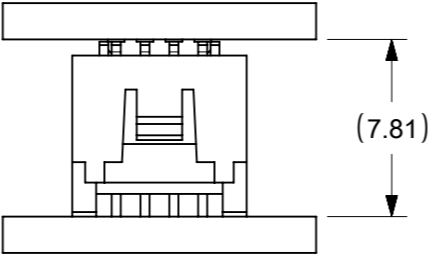
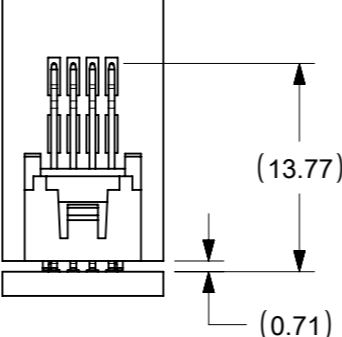
HEADER	MATES WITH (RECEPTACLE)	BTB DIST.	PICTORIAL VIEW
201021	78120	9.23	
87933		7.57	
200989		7.86	
201022		7.81	
201173		13.77	

THIS DRAWING CONTAINS INFORMATION THAT IS PROPRIETARY TO MOLEX ELECTRONIC TECHNOLOGIES, LLC AND SHOULD NOT BE USED WITHOUT WRITTEN PERMISSION

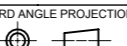
DIMENSION UNITS	SCALE	CURRENT REV DESC: REMASTERED & BTB DISTANCE UPDATE		molex		
MM	NTS					
GENERAL TOLERANCES (UNLESS SPECIFIED)				1.27MM PITCH, DUAL ROW RECEPTACLE, SMT		
	MM	INCH			PRODUCT CUSTOMER DRAWING	
4 PLACES	±	±	EC NO: 664214	DOCUMENT NUMBER		
3 PLACES	±	±	DRWN: KSUTAR	2021/05/07	SD-78120-007	
2 PLACES	± 0.15	±	CHK'D: ABABUPS	2021/05/18	PSD	001
1 PLACE	±	±	APPR: MRAMAKRISHNA	2021/05/18	A4	REVISION
0 PLACES	±	±	INITIAL REVISION:			
ANGULAR TOL ± 1.0°		DRWN: CWLAM		2007/02/16		
		APPR: KWLEE		2007/02/27		
DRAFT WHERE APPLICABLE MUST REMAIN WITHIN DIMENSIONS		THIRD ANGLE PROJECTION	DRAWING	SERIES	MATERIAL NUMBER	CUSTOMER
			A3-SIZE	78120	SEE TABLE	GENERAL MARKET
					SHEET NUMBER	
						2 OF 2