

LARISA-W-PIN

~50° wide beam and holder with location pins

SPECIFICATION:

Dimensions	9.9 x 9.9 mm
Height	7.5 mm
Fastening	glue, pin
ROHS compliant	yes ⓘ

MATERIALS:

Component	Type	Material	Colour	Finish
LARISA-W	Single lens	PMMA	clear	
LARISA-HOLDER-PIN	Holder	PC	black	

ORDERING INFORMATION:

Component		Qty in box	MOQ	MPQ	Box weight (kg)
CP15307_LARISA-W-PIN	Single lens	10000	300	100	7.1
» Box size: 300 x 250 x 250 mm					

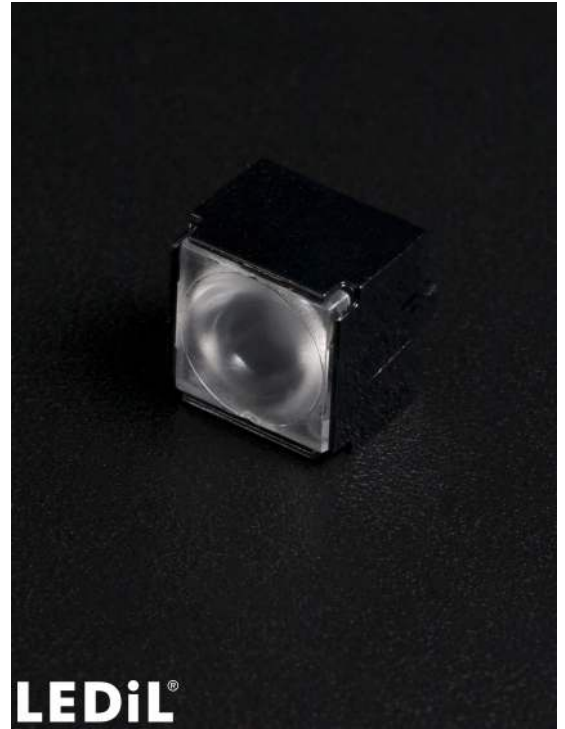

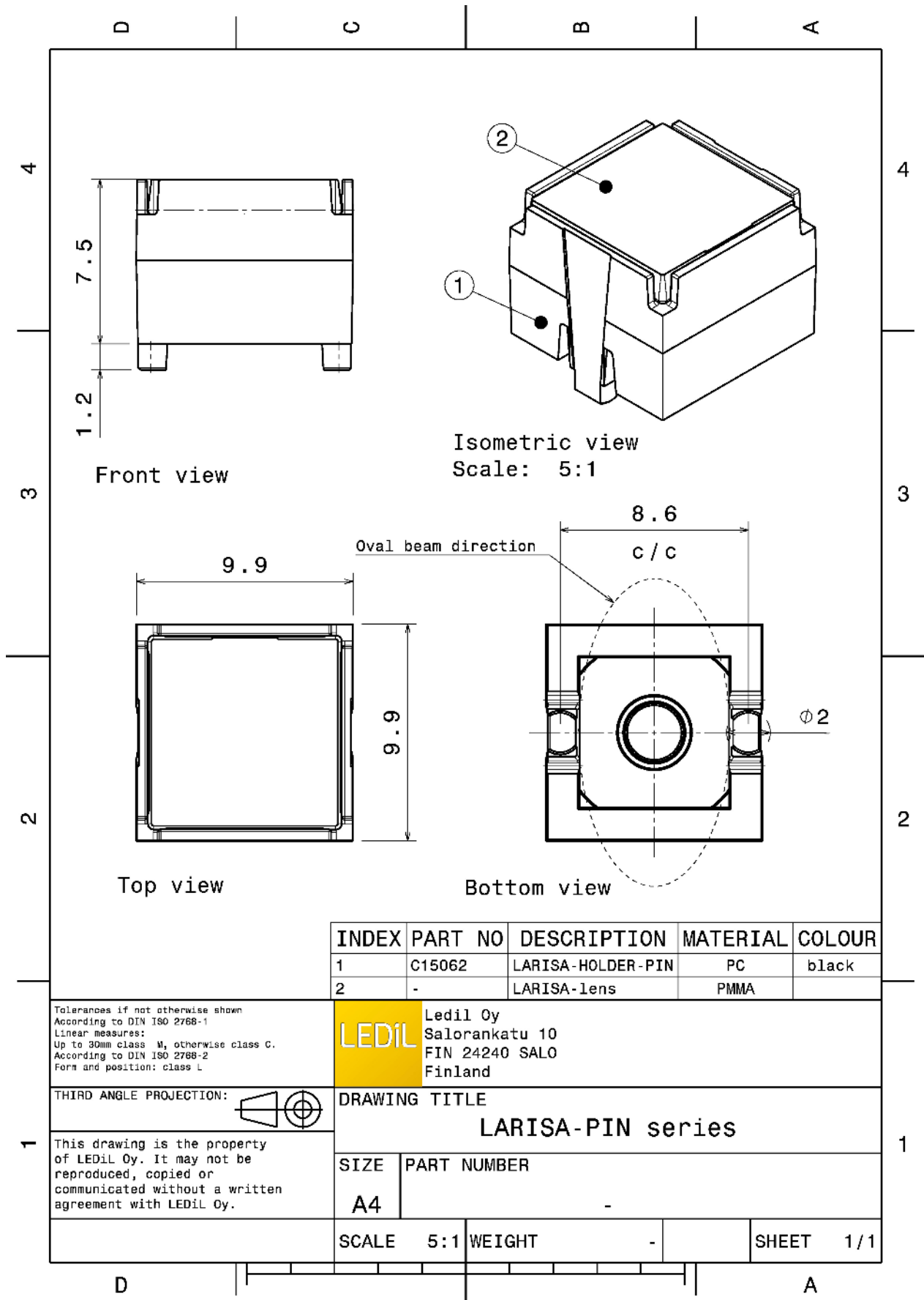

See also our general installation guide: www.ledil.com/installation_guide

OPTICAL RESULTS (MEASURED):

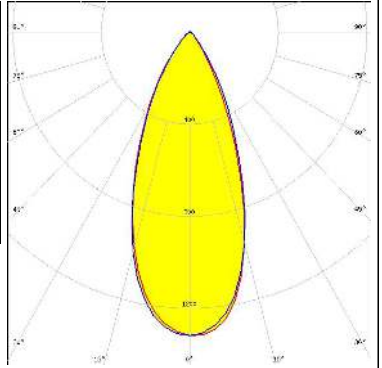
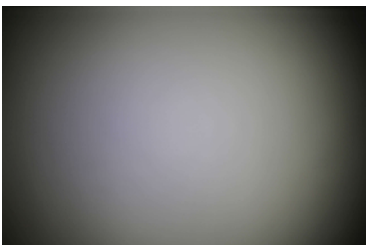
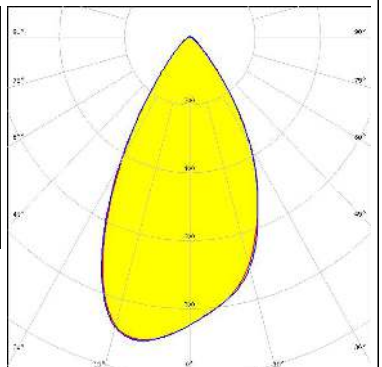
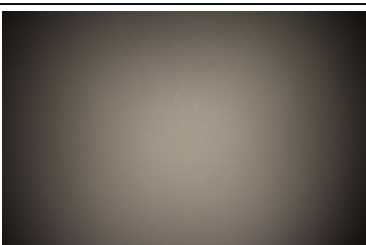
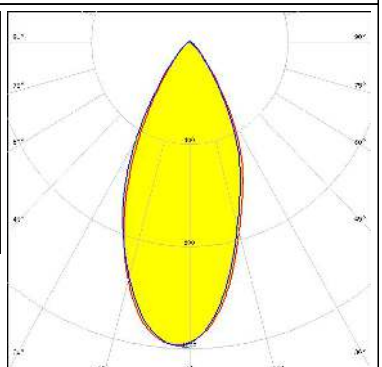
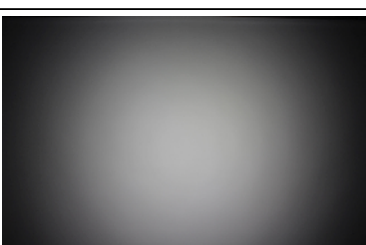
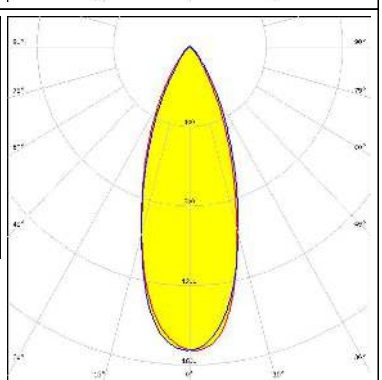
<p>CREE ⇄ LED</p> <p>LED XB-D FWHM / FWTM 43.0° / 75.0° Efficiency 79 % Peak intensity 1.3 cd/lm LEDs/each optic 1 Light colour White Required components:</p>		
<p>CREE ⇄ LED</p> <p>LED XD16 FWHM / FWTM 56.0° / 86.0° Efficiency 80 % Peak intensity 0.9 cd/lm LEDs/each optic 1 Light colour White Required components:</p>		
<p>CREE ⇄ LED</p> <p>LED XQ-E HD FWHM / FWTM 46.0° / 80.0° Efficiency 84 % Peak intensity 1.2 cd/lm LEDs/each optic 1 Light colour White Required components:</p>		
<p>CREE ⇄ LED</p> <p>LED XQ-E HI FWHM / FWTM 37.0° / 70.0° Efficiency 80 % Peak intensity 1.5 cd/lm LEDs/each optic 1 Light colour White Required components:</p>		

OPTICAL RESULTS (MEASURED):

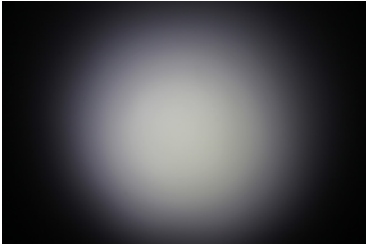
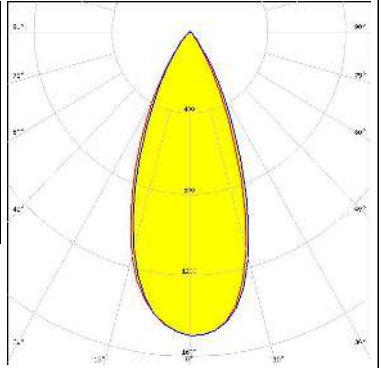
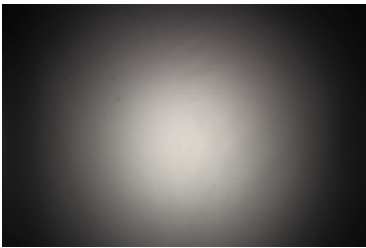
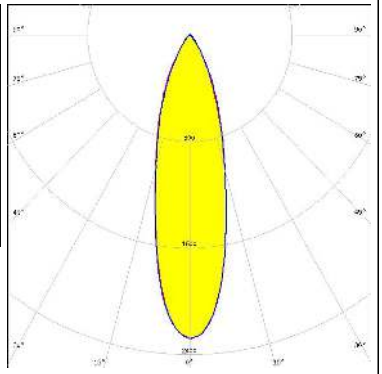
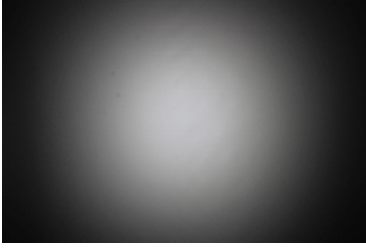
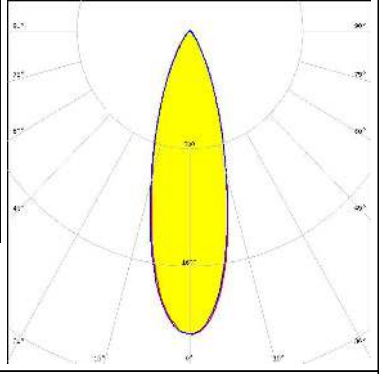
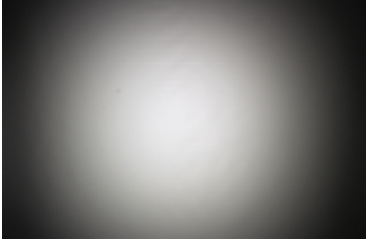
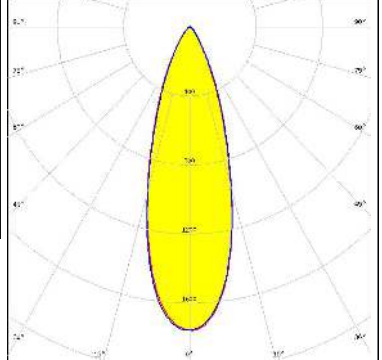
<p>LUMILEDS</p> <p>LED LUXEON C</p> <p>FWHM / FWTM 43.0° / 71.0°</p> <p>Efficiency 85 %</p> <p>Peak intensity 1.5 cd/m</p> <p>LEDs/each optic 1</p> <p>Light colour White</p> <p>Required components:</p>		
<p>LUMILEDS</p> <p>LED LUXEON Z</p> <p>FWHM / FWTM 28.0° / 62.0°</p> <p>Efficiency 83 %</p> <p>Peak intensity 2.3 cd/m</p> <p>LEDs/each optic 1</p> <p>Light colour White</p> <p>Required components:</p>		
<p>NICHIA</p> <p>LED NCSxE17A</p> <p>FWHM / FWTM 30.0° / 60.0°</p> <p>Efficiency 75 %</p> <p>Peak intensity 2.1 cd/m</p> <p>LEDs/each optic 1</p> <p>Light colour White</p> <p>Required components:</p>		
<p>NICHIA</p> <p>LED NVSxE21A</p> <p>FWHM / FWTM 32.0° / 64.0°</p> <p>Efficiency 73 %</p> <p>Peak intensity 1.8 cd/m</p> <p>LEDs/each optic 1</p> <p>Light colour White</p> <p>Required components:</p>		

OPTICAL RESULTS (SIMULATED):

OSRAM
Opto Semiconductors

LED	OSLON SSL 80
FWHM / FWTM	49.0° / 80.0°
Efficiency	83 %
Peak intensity	1.2 cd/lm
LEDs/each optic	1
Light colour	White
Required components:	

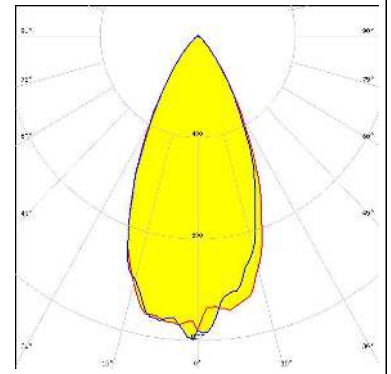

GENERAL INFORMATION:

NOTE: The typical beam angle will be changed by different color, chip size and chip position tolerance. The typical total beam angle is the full angle measured where the luminous intensity is half of the peak value.

MATERIALS:

As part of our continuous research and improvement processes, and to ensure the best possible quality and availability of our products, LEDiL reserves the right to change material grades without notice.

PRODUCT DATA USER AGREEMENT AND DISCLAIMER:

The measured data in the provided downloadable LEDiL Product Datasheets and Mechanical 2D-Drawings is rounded and provided as reference for planning. LEDiL Oy's optical specifications have been verified by conducting performance testing of the products in accordance with the company's quality system. The reported data are averaged results of multiple measurements with typical variation. LEDiL Oy reserves the right to without prior notification make changes and improvements to its products.

LEDiL Oy assumes neither warranty, nor guarantee nor any other liability of any kind for the contents and correctness of the provided data. The provided data has been generated with highest diligence but the provided data may in reality not represent the complete possible variation range of all intrinsic parameters. Therefore, in certain cases a deviation from the provided data could occur.

LEDiL Oy reserves the right to undertake technical changes of its products without further notification which could lead to changes in the provided data. LEDiL Oy assumes no liability of any kind for the possible deviation from any provided data or any other damage resulting from the usage of the provided data.

The user agrees to this disclaimer and user agreement with the download or usage of the provided files.

LEDiL Oy

Joensuunkatu 13
FI-24240 SALO
Finland

LEDiL Inc.

228 West Page Street
Suite D
Sycamore IL 60178
USA

Ledil Optics Technology (Shenzhen) Co., Ltd.

405 , Block B
Casic Motor Building
Shenzhen 518057
P.R.CHINA

Local sales and technical support

[www.ledil.com/
where_to_buy](http://www.ledil.com/where_to_buy)

Shipping locations

Salo, Finland
Hong Kong, China

Distribution Partners

[www.ledil.com/
where_to_buy](http://www.ledil.com/where_to_buy)