

* Selected Packages
U.L. RECOGNIZED
 File #E71639

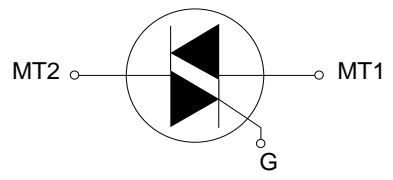
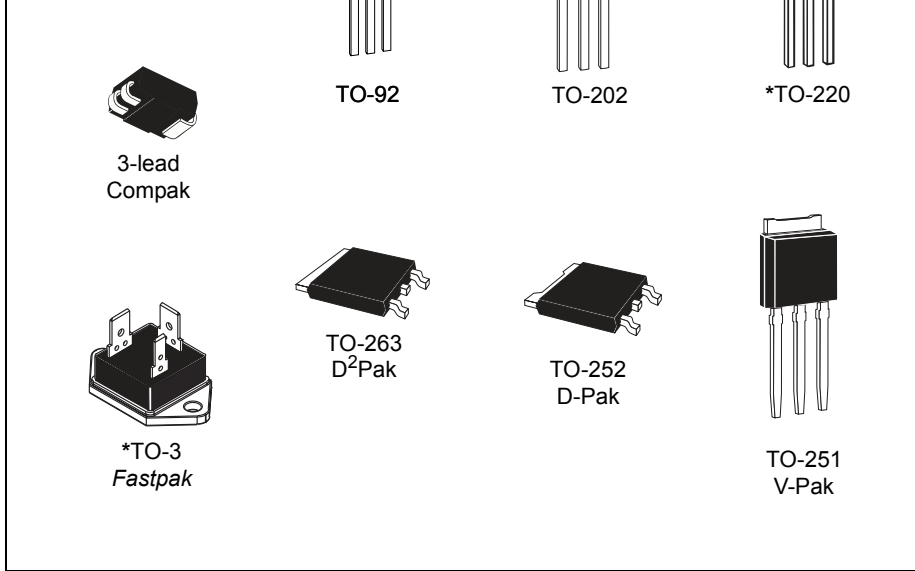

Triacs

(0.8 A to 35 A) RoHS

General Description

These gated triacs from Teccor Electronics are part of a broad line of bidirectional semiconductors. The devices range in current ratings from 0.8 A to 35 A and in voltages from 200 V to 1000 V.

The triac may be gate triggered from a blocking to conduction state for either polarity of applied voltage and is designed for AC switching and phase control applications such as speed and temperature modulation controls, lighting controls, and static switching relays. The triggering signal is normally applied between the gate and MT1.

Isolated packages are offered with internal construction, having the case or mounting tab electrically isolated from the semiconductor chip. This feature facilitates the use of low-cost assembly and convenient packaging techniques. Tape-and-reel capability is available. See "Packing Options" section of this catalog.

All Teccor triacs have glass-passivated junctions to ensure long-term device reliability and parameter stability. Teccor's glass-passivated junctions offer a rugged, reliable barrier against junction contamination.







Variations of devices covered in this data sheet are available for custom design applications. Consult factory for more information.

Features

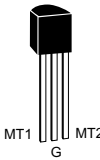
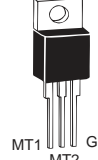
- **RoHS Compliant**
- **Electrically-isolated packages**
- **Glass-passivated junctions**
- **Voltage capability — up to 1000 V**
- **Surge capability — up to 200 A**

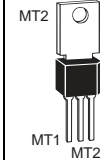
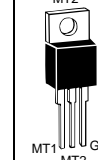
Compak Package

- **Surface mount package — 0.8 A and 1 A series**
- **New small profile three-leaded Compak package**
- **Packaged in embossed carrier tape with 2,500 devices per reel**
- **Can replace SOT-223**

| I _{T(RMS)} (4) | Part Number | | | | | | | | V _{DRM} (1) | I _{GT} (3) (7) (15) | | | | | |
|----------------------------|---|---|---|---|---|---|---|--|-------------------------|---------------------------------|-------|------|-----|-----|-----|
| | Isolated | | | Non-isolated | | | | | | Volts | mAmps | | | | |
| |  |  |  |  |  |  |  |  | | QI | QII | QIII | QIV | QIV | |
| TO-92 | TO-220 | Compak | TO-202 | TO-220 | TO-252 D-Pak | TO-251 V-Pak | TO-263 D²Pak | | | | | | | | |
| MAX | See "Package Dimensions" section for variations. (11) | | | | | | | | MIN | MAX | | | | | TYP |
| 0.8 A | Q2X8E3 | | Q2X3 | | | | | | 200 | 10 | 10 | 10 | | 25 | |
| | Q4X8E3 | | Q4X3 | | | | | | 400 | 10 | 10 | 10 | | 25 | |
| | Q6X8E3 | | Q6X3 | | | | | | 600 | 10 | 10 | 10 | | 25 | |
| | Q2X8E4 | | Q2X4 | | | | | | 200 | 25 | 25 | 25 | | 50 | |
| | Q4X8E4 | | Q4X4 | | | | | | 400 | 25 | 25 | 25 | | 50 | |
| 1 A | Q6X8E4 | | Q6X4 | | | | | | 600 | 25 | 25 | 25 | | 50 | |
| | Q201E3 | | Q2N3 | | | | | | 200 | 10 | 10 | 10 | | 25 | |
| | Q401E3 | | Q4N3 | | | | | | 400 | 10 | 10 | 10 | | 25 | |
| | Q601E3 | | Q6N3 | | | | | | 600 | 10 | 10 | 10 | | 25 | |
| | Q201E4 | | Q2N4 | | | | | | 200 | 25 | 25 | 25 | | 50 | |
| 4 A | Q401E4 | | Q4N4 | | | | | | 400 | 25 | 25 | 25 | | 50 | |
| | Q601E4 | | Q6N4 | | | | | | 600 | 25 | 25 | 25 | | 50 | |
| | | Q2004L3 | | Q2004F31 | | Q2004D3 | Q2004V3 | | 200 | 10 | 10 | 10 | | 25 | |
| | | Q4004L3 | | Q4004F31 | | Q4004D3 | Q4004V3 | | 400 | 10 | 10 | 10 | | 25 | |
| | | Q6004L3 | | Q6004F31 | | Q6004D3 | Q6004V3 | | 600 | 10 | 10 | 10 | | 25 | |
| | | Q2004L4 | | Q2004F41 | | Q2004D4 | Q2004V4 | | 200 | 25 | 25 | 25 | | 50 | |
| | | Q4004L4 | | Q4004F41 | | Q4004D4 | Q4004V4 | | 400 | 25 | 25 | 25 | | 50 | |
| | | Q6004L4 | | Q6004F41 | | Q6004D4 | Q6004V4 | | 600 | 25 | 25 | 25 | | 50 | |
| | Q8004L4 | | | | Q8004D4 | Q8004V4 | | 800 | 25 | 25 | 25 | | 50 | | |
| 6 A | | QK004L4 | | | QK004D4 | QK004V4 | | 1000 | 25 | 25 | 25 | | 50 | | |
| | | Q2006L4 | | Q2006F41 | Q2006R4 | | Q2006N4 | 200 | 25 | 25 | 25 | | 50 | | |
| | | Q4006L4 | | Q4006F41 | Q4006R4 | | Q4006N4 | 400 | 25 | 25 | 25 | | 50 | | |
| | | Q6006L5 | | Q6006F51 | Q6006R5 | | Q6006N5 | 600 | 50 | 50 | 50 | | 75 | | |
| | | Q8006L5 | | | Q8006R5 | | Q8006N5 | 800 | 50 | 50 | 50 | | 75 | | |
| 8 A | | QK006L5 | | | QK006R5 | | QK006N5 | 1000 | 50 | 50 | 50 | | 75 | | |
| | | Q2008L4 | | Q2008F41 | Q2008R4 | | Q2008N4 | 200 | 25 | 25 | 25 | | 50 | | |
| | | Q4008L4 | | Q4008F41 | Q4008R4 | | Q4008N4 | 400 | 25 | 25 | 25 | | 50 | | |
| | | Q6008L5 | | Q6008F51 | Q6008R5 | | Q6008N5 | 600 | 50 | 50 | 50 | | 75 | | |
| | | Q8008L5 | | | Q8008R5 | | Q8008N5 | 800 | 50 | 50 | 50 | | 75 | | |
| | QK008L5 | | | QK008R5 | | QK008N5 | 1000 | 50 | 50 | 50 | | 75 | | | |

See "General Notes" on page E2 - 4 and "Electrical Specification Notes" on page E2 - 5.

| I_{DRM} | | | V_{TM} | V_{GT} | I_H | I_{GTM} | P_{GM} | $P_{G(AV)}$ | I_{TSM} | $dv/dt(c)$ | dv/dt | | t_{gt} | I^2t | di/dt |
|--------------------|---------------------|---------------------|--------------------|------------------------------|-----------------|-----------|----------|-------------|-----------|------------------|---------------------|---------------------|-----------|----------------------|-----------------|
| (1) (16) | | | (1) (5) | (2) (6) (15) (18) (19) | (1) (8) (12) | (14) | (14) | | (9) (13) | (1) (4) (13) | (1) | | (10) | | |
| mAmps | | | Volts | Volts | | | | | Amps | | Volts/ μ Sec | | | | |
| $T_C = 25^\circ C$ | $T_C = 100^\circ C$ | $T_C = 125^\circ C$ | $T_C = 25^\circ C$ | $T_C = 25^\circ C$ | mAmps | Amps | Watts | Watts | 60/50 Hz | Volts/ μ Sec | $T_C = 100^\circ C$ | $T_C = 125^\circ C$ | μ Sec | Amp ² Sec | Amps/ μ Sec |
| MAX | | | MAX | MAX | MAX | | | | | TYP | MIN | | TYP | | |
| 0.02 | 0.5 | 1 | 1.6 | 2 | 15 | 1 | 10 | 0.2 | 10/8.3 | 1 | 40 | 30 | 2.5 | 0.41 | 20 |
| 0.02 | 0.5 | 1 | 1.6 | 2 | 15 | 1 | 10 | 0.2 | 10/8.3 | 1 | 35 | 25 | 2.5 | 0.41 | 20 |
| 0.02 | 0.5 | 1 | 1.6 | 2 | 15 | 1 | 10 | 0.2 | 10/8.3 | 1 | 25 | 15 | 2.5 | 0.41 | 20 |
| 0.02 | 0.5 | 1 | 1.6 | 2.5 | 25 | 1 | 10 | 0.2 | 10/8.3 | 1 | 50 | 40 | 3 | 0.41 | 20 |
| 0.02 | 0.5 | 1 | 1.6 | 2.5 | 25 | 1 | 10 | 0.2 | 10/8.3 | 1 | 45 | 35 | 3 | 0.41 | 20 |
| 0.02 | 0.5 | 1 | 1.6 | 2.5 | 25 | 1 | 10 | 0.2 | 10/8.3 | 1 | 35 | 25 | 3 | 0.41 | 20 |
| 0.02 | 0.5 | 1 | 1.6 | 2 | 15 | 1 | 10 | 0.2 | 20/16.7 | 1 | 40 | 30 | 2.5 | 1.6 | 30 |
| 0.02 | 0.5 | 1 | 1.6 | 2 | 15 | 1 | 10 | 0.2 | 20/16.7 | 1 | 40 | 30 | 2.5 | 1.6 | 30 |
| 0.02 | 0.5 | 1 | 1.6 | 2 | 15 | 1 | 10 | 0.2 | 20/16.7 | 1 | 30 | 20 | 2.5 | 1.6 | 30 |
| 0.02 | 0.5 | 1 | 1.6 | 2.5 | 25 | 1 | 10 | 0.2 | 20/16.7 | 1 | 50 | 40 | 3 | 1.6 | 30 |
| 0.02 | 0.5 | 1 | 1.6 | 2.5 | 25 | 1 | 10 | 0.2 | 20/16.7 | 1 | 50 | 40 | 3 | 1.6 | 30 |
| 0.02 | 0.5 | 1 | 1.6 | 2.5 | 25 | 1 | 10 | 0.2 | 20/16.7 | 1 | 40 | 30 | 3 | 1.6 | 30 |
| 0.05 | 0.5 | 2 | 1.6 | 2 | 20 | 1.2 | 15 | 0.3 | 55/46 | 2 | 50 | 40 | 2.5 | 12.5 | 50 |
| 0.05 | 0.5 | 2 | 1.6 | 2 | 20 | 1.2 | 15 | 0.3 | 55/46 | 2 | 50 | 40 | 2.5 | 12.5 | 50 |
| 0.05 | 0.5 | 2 | 1.6 | 2 | 20 | 1.2 | 15 | 0.3 | 55/46 | 2 | 40 | 30 | 2.5 | 12.5 | 50 |
| 0.05 | 0.5 | 2 | 1.6 | 2.5 | 30 | 1.2 | 15 | 0.3 | 55/46 | 2 | 100 | 75 | 3 | 12.5 | 50 |
| 0.05 | 0.5 | 2 | 1.6 | 2.5 | 30 | 1.2 | 15 | 0.3 | 55/46 | 2 | 100 | 75 | 3 | 12.5 | 50 |
| 0.05 | 0.5 | 2 | 1.6 | 2.5 | 30 | 1.2 | 15 | 0.3 | 55/46 | 2 | 75 | 50 | 3 | 12.5 | 50 |
| 0.05 | 0.5 | 2 | 1.6 | 2.5 | 30 | 1.2 | 15 | 0.3 | 55/46 | 2 | 60 | 40 | 3 | 12.5 | 50 |
| 0.05 | 3 | | 1.6 | 2.5 | 30 | 1.2 | 15 | 0.3 | 55/46 | 2 | 50 | | 3 | 12.5 | 50 |
| 0.05 | 0.5 | 2 | 1.6 | 2.5 | 50 | 1.6 | 18 | 0.5 | 80/65 | 4 | 200 | 120 | 3 | 26.5 | 70 |
| 0.05 | 0.5 | 2 | 1.6 | 2.5 | 50 | 1.6 | 18 | 0.5 | 80/65 | 4 | 200 | 120 | 3 | 26.5 | 70 |
| 0.05 | 0.5 | 2 | 1.6 | 2.5 | 50 | 1.6 | 18 | 0.5 | 80/65 | 4 | 150 | 100 | 3 | 26.5 | 70 |
| 0.05 | 0.5 | 2 | 1.6 | 2.5 | 50 | 1.6 | 18 | 0.5 | 80/65 | 4 | 125 | 85 | 3 | 26.5 | 70 |
| 0.05 | 3 | | 1.6 | 2.5 | 50 | 1.6 | 18 | 0.5 | 80/65 | 4 | 100 | | 3 | 26.5 | 70 |
| 0.05 | 0.5 | 2 | 1.6 | 2.5 | 50 | 1.8 | 20 | 0.5 | 100/83 | 4 | 250 | 150 | 3 | 41 | 70 |
| 0.05 | 0.5 | 2 | 1.6 | 2.5 | 50 | 1.8 | 20 | 0.5 | 100/83 | 4 | 250 | 150 | 3 | 41 | 70 |
| 0.05 | 0.5 | 2 | 1.6 | 2.5 | 50 | 1.8 | 20 | 0.5 | 100/83 | 4 | 220 | 125 | 3 | 41 | 70 |
| 0.05 | 0.5 | 2 | 1.6 | 2.5 | 50 | 1.8 | 20 | 0.5 | 100/83 | 4 | 150 | 100 | 3 | 41 | 70 |
| 0.05 | 3 | | 1.6 | 2.5 | 50 | 1.8 | 20 | 0.5 | 100/83 | 4 | 100 | | 3 | 41 | 70 |

See "General Notes" on page E2 - 4 and "Electrical Specification Notes" on page E2 - 5.

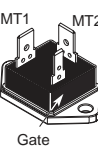
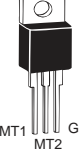
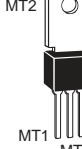
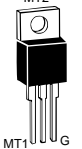
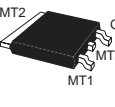
| I _{T(RMS)} (4) (16) | Part Number | | | | | V _{DRM} (1) | I _{GT} | | | | | I _{DRM} | | | |
|---------------------------------|---|---|---|---|---|-------------------------|-----------------|-----|------|-----|-----|------------------------|-------------------------|-------------------------|--|
| | Isolated | | Non-isolated | | | | mAmps | | | | | mAmps | | | |
| |  |  |  |  |  | Volts | QI | QII | QIII | QIV | QIV | T _C = 25 °C | T _C = 100 °C | T _C = 125 °C | |
| MAX | See "Package Dimensions" section for variations. (11) | | | | | MIN | MAX | | | | | TYP | MAX | | |
| 10 A | | Q2010L4 | | Q2010R4 | Q2010N4 | 200 | 25 | 25 | 25 | 50 | | 0.05 | 1 | | |
| | | Q4010L4 | | Q4010R4 | Q4010N4 | 400 | 25 | 25 | 25 | 50 | | 0.05 | 1 | | |
| | | Q6010L4 | | Q6010R4 | Q6010N4 | 600 | 25 | 25 | 25 | 50 | | 0.05 | 1 | | |
| | | Q8010L4 | | Q8010R4 | Q8010N4 | 800 | 25 | 25 | 25 | 50 | | 0.1 | 1 | | |
| | | QK010L4 | | QK010R4 | QK010N4 | 1000 | 25 | 25 | 25 | 50 | | 0.1 | 3 | | |
| | | Q2010L5 | Q2010F51 | Q2010R5 | Q2010N5 | 200 | 50 | 50 | 50 | | 75 | 0.05 | 0.5 | 2 | |
| | | Q4010L5 | Q4010F51 | Q4010R5 | Q4010N5 | 400 | 50 | 50 | 50 | | 75 | 0.05 | 0.5 | 2 | |
| | | Q6010L5 | Q6010F51 | Q6010R5 | Q6010N5 | 600 | 50 | 50 | 50 | | 75 | 0.05 | 0.5 | 2 | |
| 15 A | | | | Q8010R5 | Q8010N5 | 800 | 50 | 50 | 50 | | 75 | 0.1 | 0.5 | 2 | |
| | | QK010L5 | | QK010R5 | QK010N5 | 1000 | 50 | 50 | 50 | | 75 | 0.1 | 3 | | |
| | | Q2015L5 | | Q2015R5 | Q2015N5 | 200 | 50 | 50 | 50 | | | 0.05 | 0.5 | 2 | |
| | | Q4015L5 | | Q4015R5 | Q4015N5 | 400 | 50 | 50 | 50 | | | 0.05 | 0.5 | 2 | |
| | | Q6015L5 | | Q6015R5 | Q6015N5 | 600 | 50 | 50 | 50 | | | 0.05 | 0.5 | 2 | |
| 25 A | | | | Q8015R5 | Q8015N5 | 800 | 50 | 50 | 50 | | | 0.1 | 1 | 3 | |
| | | | | QK015L5 | QK015N5 | 1000 | 50 | 50 | 50 | | | 0.1 | 3 | | |
| | | | | Q2025R5 | Q2025N5 | 200 | 50 | 50 | 50 | | | 0.1 | 1 | 3 | |
| | | | | Q4025R5 | Q4025N5 | 400 | 50 | 50 | 50 | | | 0.1 | 1 | 3 | |
| | | | | Q6025R5 | Q6025N5 | 600 | 50 | 50 | 50 | | | 0.1 | 1 | 3 | |
| | | | | Q8025R5 | Q8025N5 | 800 | 50 | 50 | 50 | | | 0.1 | 1 | 3 | |
| 35 A | | QK025R5 | | QK025N5 | | 1000 | 50 | 50 | 50 | | | 0.1 | 3 | | |
| | | Q6025P5 | | | | 600 | 50 | 50 | 50 | | 120 | 0.1 | | 5 | |
| | | Q8025P5 | | | | 800 | 50 | 50 | 50 | | 120 | 0.1 | | 5 | |
| | | Q6035P5 | | | | 600 | 50 | 50 | 50 | | 120 | 0.1 | | 5 | |
| | Q8035P5 | | | | 800 | 50 | 50 | 50 | | 120 | 0.1 | | 5 | | |

Specific Test Conditions

- di/dt** — Maximum rate-of-change of on-state current; I_{GT} = 200 mA with ≤0.1 μs rise time
- dv/dt** — Critical rate-of-rise of off-state voltage at rated V_{DRM} gate open
- dv/dt(c)** — Critical rate-of-rise of commutation voltage at rated V_{DRM} and I_{T(RMS)} commutating di/dt = 0.54 rated I_{T(RMS)}/ms; gate unenergized
- I²t** — RMS surge (non-repetitive) on-state current for period of 8.3 ms for fusing
- I_{DRM}** — Peak off-state current, gate open; V_{DRM} = maximum rated value
- I_{GT}** — DC gate trigger current in specific operating quadrants; V_D = 12 V dc
- I_{GTM}** — Peak gate trigger current
- I_H** — Holding current (DC); gate open
- I_{T(RMS)}** — RMS on-state current conduction angle of 360°
- I_{TSM}** — Peak one-cycle surge
- P_{G(AV)}** — Average gate power dissipation
- P_{GM}** — Peak gate power dissipation; I_{GT} ≤ I_{GTM}
- t_{gt}** — Gate controlled turn-on time; I_{GT} = 200 mA with 0.1 μs rise time

- V_{DRM}** — Repetitive peak blocking voltage
- V_{GT}** — DC gate trigger voltage; V_D = 12 V dc; R_L = 60 Ω
- V_{TM}** — Peak on-state voltage at maximum rated RMS current

General Notes

- All measurements are made at 60 Hz with a resistive load at an ambient temperature of +25 °C unless specified otherwise.
- Operating temperature range (T_J) is -65 °C to +125 °C for TO-92, -25 °C to +125 °C for Fastpak, and -40 °C to +125 °C for all other devices.
- Storage temperature range (T_S) is -65 °C to +150 °C for TO-92, -40 °C to +150 °C for TO-202, and -40 °C to +125 °C for all other devices.
- Lead solder temperature is a maximum of 230 °C for 10 seconds, maximum; ≥1/16" (1.59 mm) from case.
- The case temperature (T_C) is measured as shown on the dimensional outline drawings. See "Package Dimensions" section of this catalog.

| V_{TM} | V_{GT} | I_H | I_{GTM} | P_{GM} | $P_{G(AV)}$ | I_{TSM} | $dv/dt(c)$ | dv/dt | | t_{gt} | I^2t | di/dt |
|--------------------|---------------------------|--------------|-----------|----------|-------------|-----------|------------------|---------------------|---------------------|-----------|-----------------------|-----------------|
| (1) (5) | (2) (6) (15) (18) (19) | (1) (8) (12) | (14) | (14) | | (9) (13) | (1) (4) (13) | (1) | | (10) (17) | | |
| Volts | Volts | | | | | Amps | | Volts/ μ Sec | | | | |
| $T_C = 25^\circ C$ | $T_C = 25^\circ C$ | mAmps | Amps | Watts | Watts | 60/50 Hz | Volts/ μ Sec | $T_C = 100^\circ C$ | $T_C = 125^\circ C$ | μ Sec | Amps ² Sec | Amps/ μ Sec |
| MAX | MAX | MAX | | | | | TYP | MIN | | TYP | | |
| 1.6 | 2.5 | 35 | 1.8 | 20 | 0.5 | 120/100 | 2 | 150 | | 3 | 60 | 70 |
| 1.6 | 2.5 | 35 | 1.8 | 20 | 0.5 | 120/100 | 2 | 150 | | 3 | 60 | 70 |
| 1.6 | 2.5 | 35 | 1.8 | 20 | 0.5 | 120/100 | 2 | 100 | | 3 | 60 | 70 |
| 1.6 | 2.5 | 35 | 1.8 | 20 | 0.5 | 120/100 | 2 | 75 | | 3 | 60 | 70 |
| 1.6 | 2.5 | 35 | 1.8 | 20 | 0.5 | 120/100 | 2 | 50 | | 3 | 60 | 70 |
| 1.6 | 2.5 | 50 | 1.8 | 20 | 0.5 | 120/100 | 4 | 350 | 225 | 3 | 60 | 70 |
| 1.6 | 2.5 | 50 | 1.8 | 20 | 0.5 | 120/100 | 4 | 350 | 225 | 3 | 60 | 70 |
| 1.6 | 2.5 | 50 | 1.8 | 20 | 0.5 | 120/100 | 4 | 300 | 200 | 3 | 60 | 70 |
| 1.6 | 2.5 | 50 | 1.8 | 20 | 0.5 | 120/100 | 4 | 250 | 175 | 3 | 60 | 70 |
| 1.6 | 2.5 | 50 | 1.8 | 20 | 0.5 | 120/100 | 4 | 150 | | 3 | 60 | 70 |
| 1.6 | 2.5 | 70 | 2 | 20 | 0.5 | 200/167 | 4 | 400 | 275 | 4 | 166 | 100 |
| 1.6 | 2.5 | 70 | 2 | 20 | 0.5 | 200/167 | 4 | 400 | 275 | 4 | 166 | 100 |
| 1.6 | 2.5 | 70 | 2 | 20 | 0.5 | 200/167 | 4 | 350 | 225 | 4 | 166 | 100 |
| 1.6 | 2.5 | 70 | 2 | 20 | 0.5 | 200/167 | 4 | 300 | 200 | 4 | 166 | 100 |
| 1.6 | 2.5 | 70 | 2 | 20 | 0.5 | 200/167 | 4 | 200 | | 4 | 166 | 100 |
| 1.8 | 2.5 | 100 | 2 | 20 | 0.5 | 200/167 | 5 | 400 | 275 | 4 | 166 | 100 |
| 1.8 | 2.5 | 100 | 2 | 20 | 0.5 | 200/167 | 5 | 400 | 275 | 4 | 166 | 100 |
| 1.8 | 2.5 | 100 | 2 | 20 | 0.5 | 200/167 | 5 | 350 | 225 | 4 | 166 | 100 |
| 1.8 | 2.5 | 100 | 2 | 20 | 0.5 | 200/167 | 5 | 300 | 200 | 4 | 166 | 100 |
| 1.8 | 2.5 | 100 | 2 | 20 | 0.5 | 200/167 | 5 | 200 | | 4 | 166 | 100 |
| 1.4 | 2.75 | 50 | 2 | 20 | 0.5 | 250/220 | 5 | 550 | 475 | 3 | 260 | 100 |
| 1.4 | 2.75 | 50 | 2 | 20 | 0.5 | 250/220 | 5 | 450 | 400 | 3 | 260 | 100 |
| 1.5 | 2.75 | 50 | 2 | 20 | 0.5 | 350/300 | 5 | 550 | 475 | 3 | 508 | 100 |
| 1.5 | 2.75 | 50 | 2 | 20 | 0.5 | 350/300 | 5 | 450 | 400 | 3 | 508 | 100 |

Electrical Specification Notes

- (1) For either polarity of MT2 with reference to MT1 terminal
- (2) For either polarity of gate voltage (V_{GT}) with reference to MT1 terminal
- (3) See Gate Characteristics and Definition of Quadrants.
- (4) See Figure E2.1 through Figure E2.7 for current rating at specific operating temperature.
- (5) See Figure E2.8 through Figure E2.10 for i_T versus v_T .
- (6) See Figure E2.12 for V_{GT} versus T_C .
- (7) See Figure E2.11 for I_{GT} versus T_C .
- (8) See Figure E2.14 for I_H versus T_C .
- (9) See Figure E2.13 for surge rating with specific durations.
- (10) See Figure E2.15 for t_{gt} versus I_{GT} .
- (11) See package outlines for lead form configurations. When ordering special lead forming, add type number as suffix to part number.
- (12) Initial on-state current = 200 mA dc for 0.8 A to 10 A devices, 400 mA dc for 15 A to 35 A devices
- (13) See Figure E2.1 through Figure E2.6 for maximum allowable case temperature at maximum rated current.
- (14) Pulse width $\leq 10 \mu s$; $I_{GT} \leq I_{GTM}$

- (15) $R_L = 60 \Omega$ for 0.8 A to 10 A triacs; $R_L = 30 \Omega$ for 15 A to 35 A triacs
- (16) $T_C = T_J$ for test conditions in off state
- (17) $I_{GT} = 300$ mA for 25 A and 35 A devices
- (18) Quadrants I, II, III only
- (19) Minimum non-trigger V_{GT} at 125 °C is 0.2 V for all except 50 mA MAX QIV devices which are 0.2 V at 110 °C.

Gate Characteristics

Teccor triacs may be turned on between gate and MT1 terminals in the following ways:

- In-phase signals (with standard AC line) using Quadrants I and III
- Application of unipolar pulses (gate always positive or negative), using Quadrants II and III with negative gate pulses and Quadrants I and IV with positive gate pulses

However, due to higher gate requirements for Quadrant IV, it is recommended that only negative pulses be applied. If positive pulses are required, see "Sensitive Triacs" section of this catalog or contact the factory. Also, see Figure AN1002.8, "Amplified Gate" Thyristor Circuit.

In all cases, if maximum surge capability is required, pulses should be a minimum of one magnitude above I_{GT} rating with a steep rising waveform ($\leq 1 \mu s$ rise time).

Electrical Isolation

Teccor's isolated triac packages will withstand a minimum high potential test of 2500 V ac rms from leads to mounting tab or base, over the operating temperature range of the device. The following isolation table shows standard and optional isolation ratings.

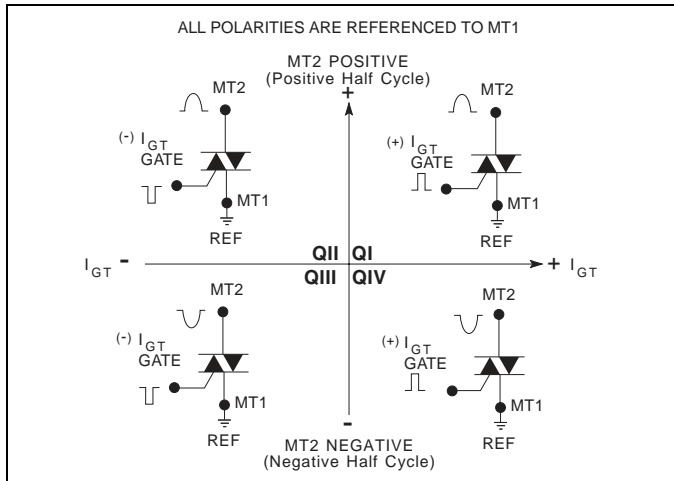





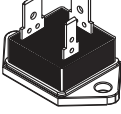

Definition of Quadrants

| Electrical Isolation from Leads to Mounting Tab * | | |
|---|-----------------|------------------|
| V AC RMS | TO-220 Isolated | Fastpak Isolated |
| 2500 | Standard | Standard |
| 4000 | Optional ** | N/A |

* UL Recognized File E71639

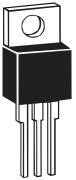
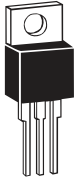
** For 4000 V isolation, use V suffix in part number.

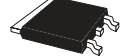
| Thermal Resistance (Steady State) $R_{\theta JC}$ [$R_{\theta JA}$] (TYP.) °C/W | | | | | | | | | | |
|--|---|---|---|---|--|---|--|---|---|--|
| Package Code | P | E | C | F | F2 | L | R | D | V | N |
| Type |  TO-3 Fastpak |  TO-92 |  Compak |  TO-202 Type 1 |  TO-202 Type 2 |  TO-220 Isolated |  TO-220 Non-isolated |  TO-252 D-Pak |  TO-251 V-Pak |  TO-263 D ² Pak |
| 0.8 A | | 60 [135] | 60 * | | | | | | | |
| 1 A | | 50 [95] | 40 * | | | | | | | |
| 4 A | | | | 3.5 [45] | 6 [70] | 3.6 [50] | | 3.5 | 6.0 [70] | |
| 6 A | | | | 3.8 | | 3.3 | 1.8 [45] | | | 1.8 |
| 8 A | | | | 3.3 | | 2.8 | 1.5 | | | 1.5 |
| 10 A | | | | 3.5 | | 2.6 | 1.3 | | | 1.3 |
| 15 A | | | | | | 2.1 | 1.1 | | | 1.1 |
| 25 A | 1.6 | | | | | | 0.89 | | | 0.89 |
| 35 A | 1.5 | | | | | | | | | |

* Mounted on 1 cm² copper foil surface; two-ounce copper foil

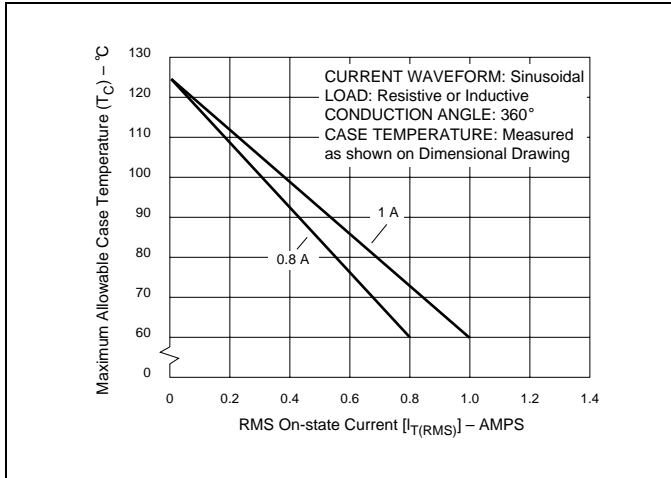

Figure E2.1 Maximum Allowable Case Temperature versus On-state Current (0.8 A and 1 A)

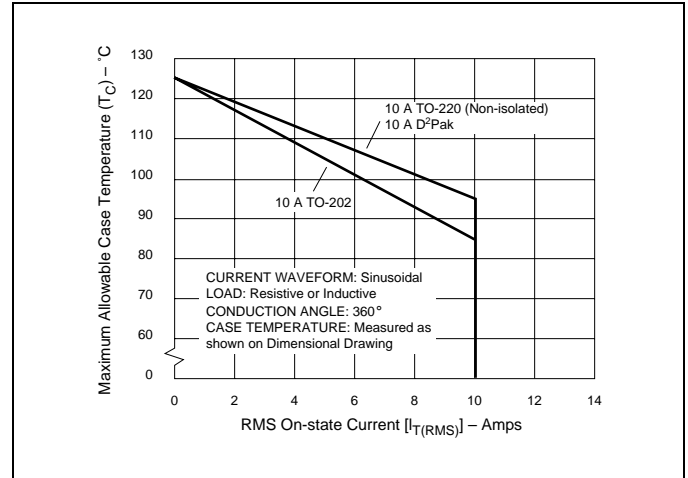

Figure E2.4 Maximum Allowable Case Temperature versus On-state Current (10 A)

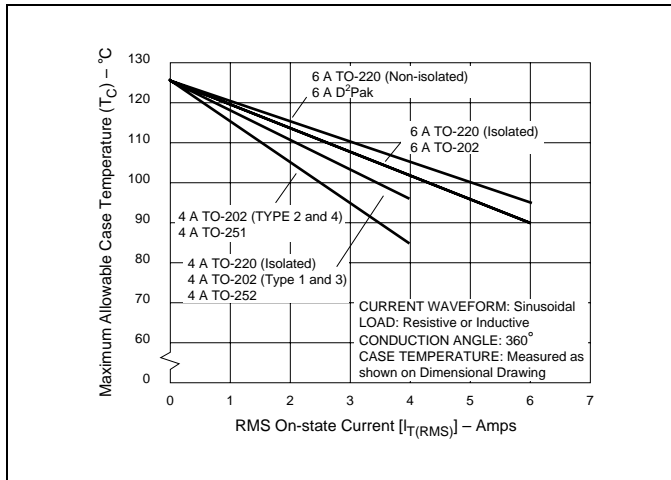

Figure E2.2 Maximum Allowable Case Temperature versus On-state Current (4 A and 6 A)

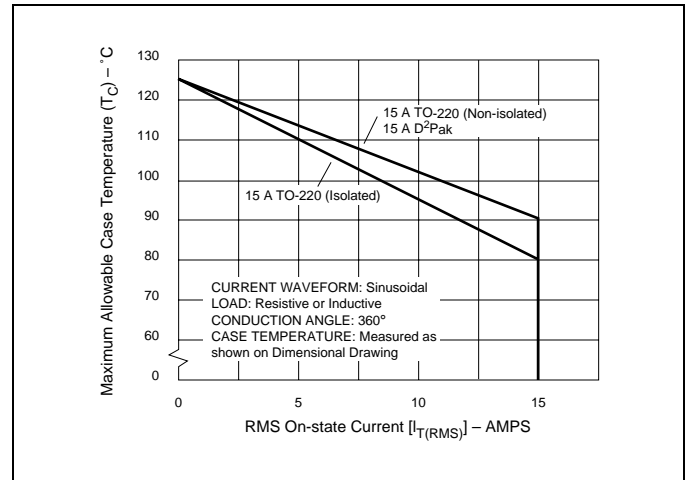

Figure E2.5 Maximum Allowable Case Temperature versus On-state Current (15 A)

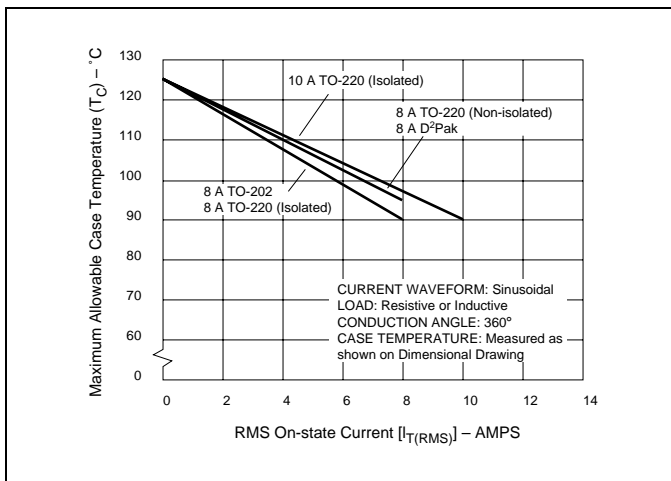

Figure E2.3 Maximum Allowable Case Temperature versus On-state Current (8 A and 10 A)

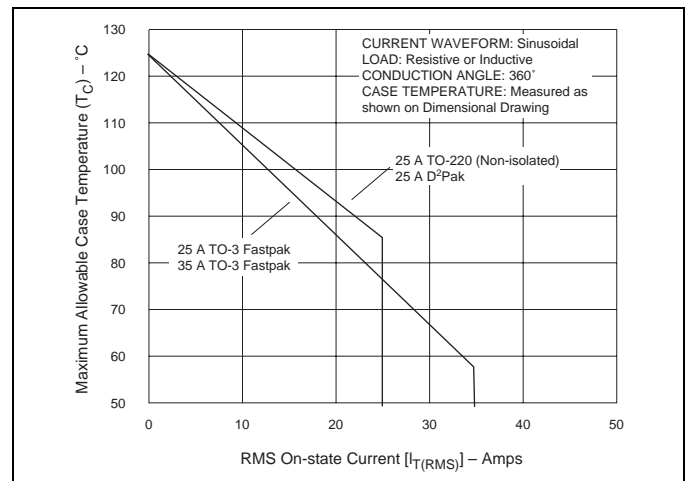

Figure E2.6 Maximum Allowable Case Temperature versus On-state Current (25 A and 35 A)

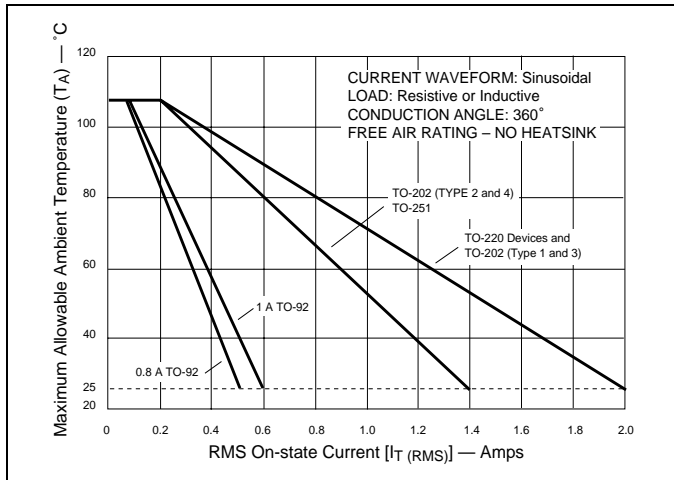

Figure E2.7 Maximum Allowable Ambient Temperature versus On-state Current

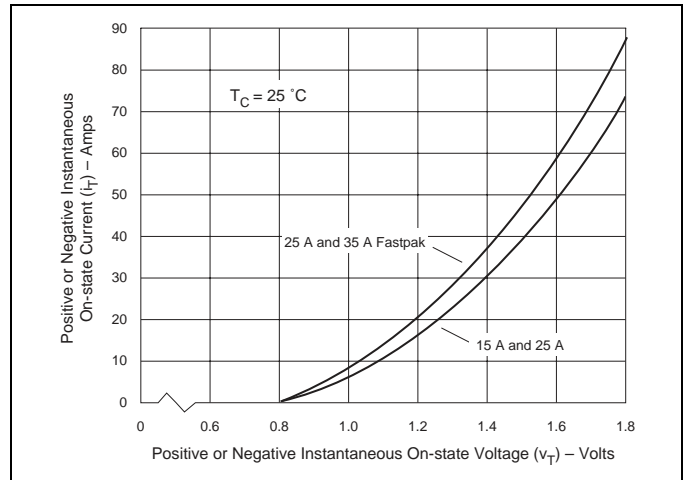

Figure E2.10 On-state Current versus On-state Voltage (Typical) (15 A and 25 A)

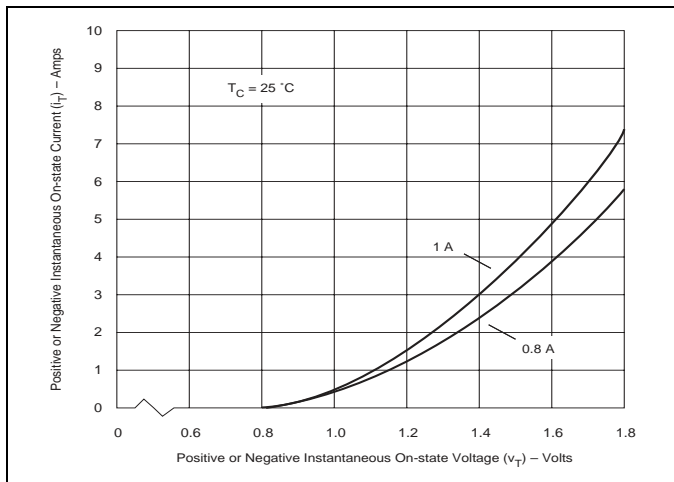

Figure E2.8 On-state Current versus On-state Voltage (Typical) (0.8 A and 1 A)

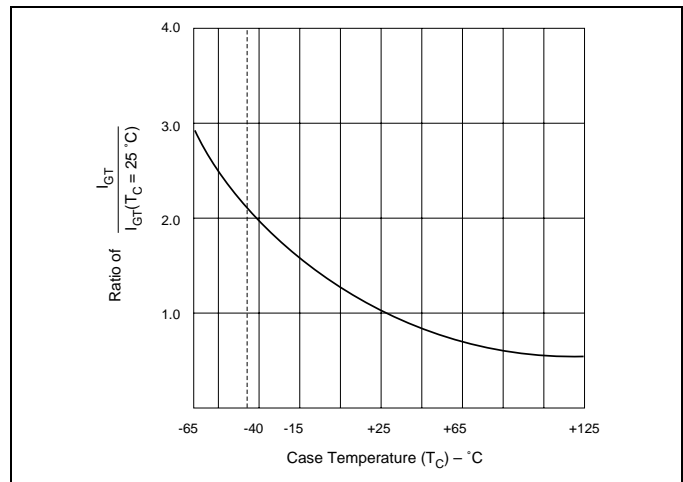

Figure E2.11 Normalized DC Gate Trigger Current for All Quadrants versus Case Temperature

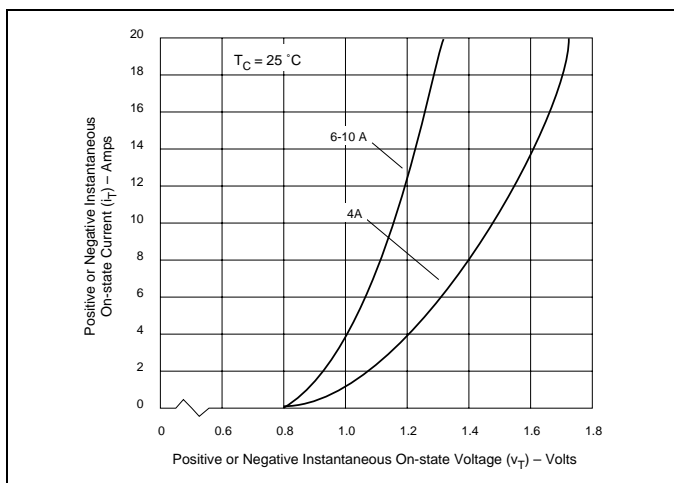

Figure E2.9 On-state Current versus On-state Voltage (Typical) (4 A, 6 A, 8 A, and 10 A)

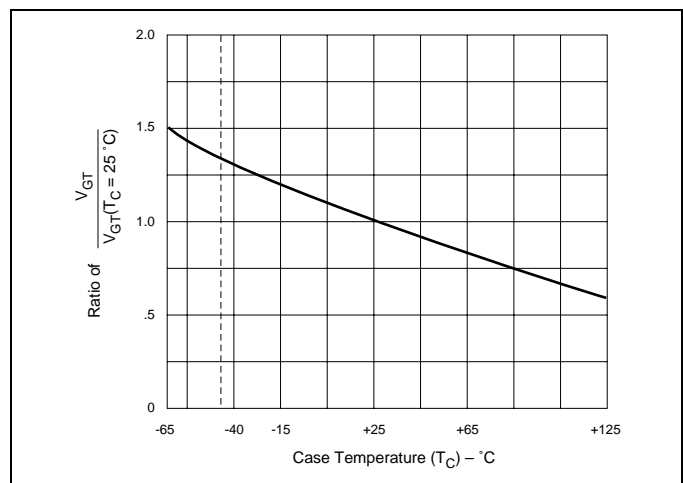

Figure E2.12 Normalized DC Gate Trigger Voltage for All Quadrants versus Case Temperature

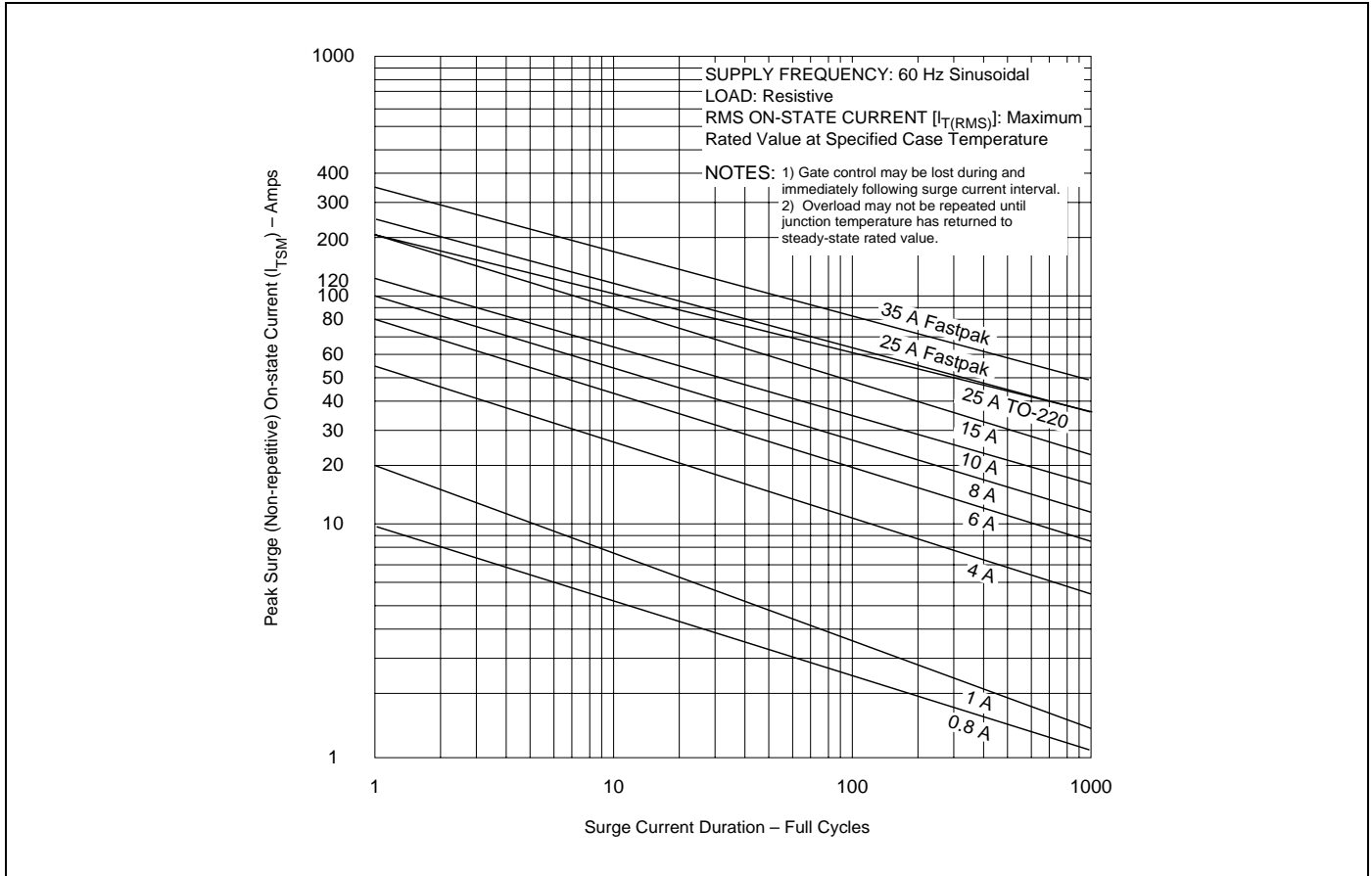

Figure E2.13 Peak Surge Current versus Surge Current Duration

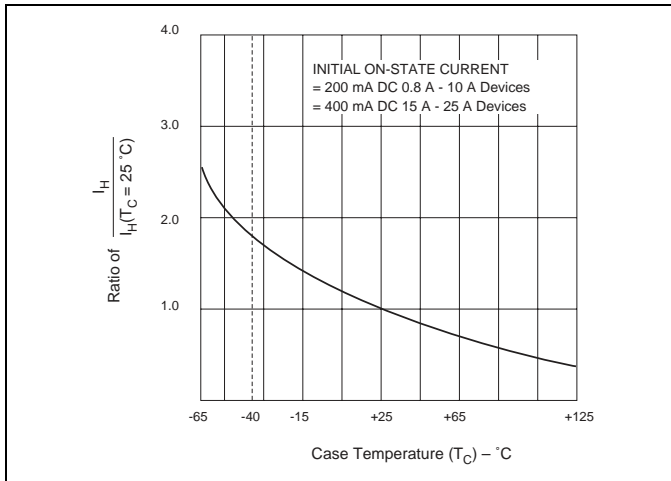

Figure E2.14 Normalized DC Holding Current versus Case Temperature

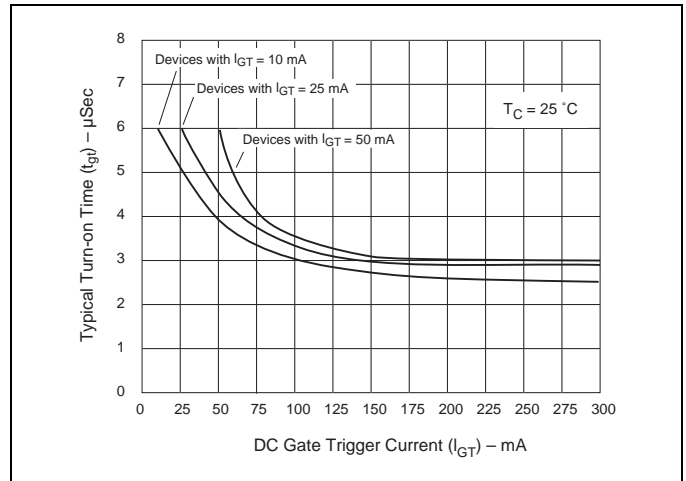

Figure E2.15 Turn-on Time versus Gate Trigger Current (Typical)

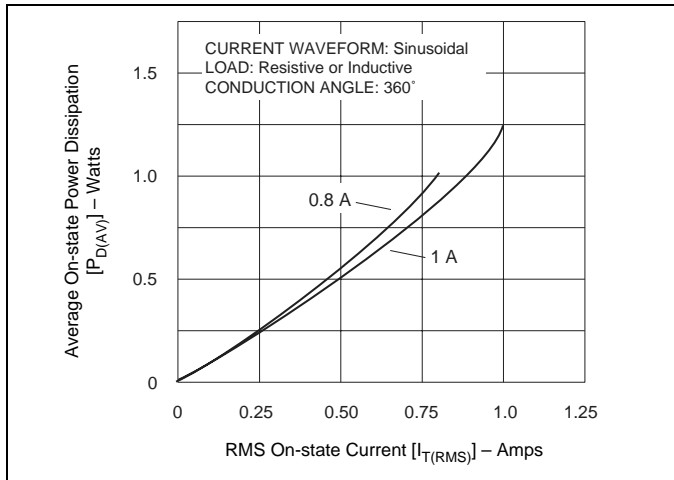

Figure E2.16 Power Dissipation (Typical) versus On-state Current (0.8 A and 1 A)

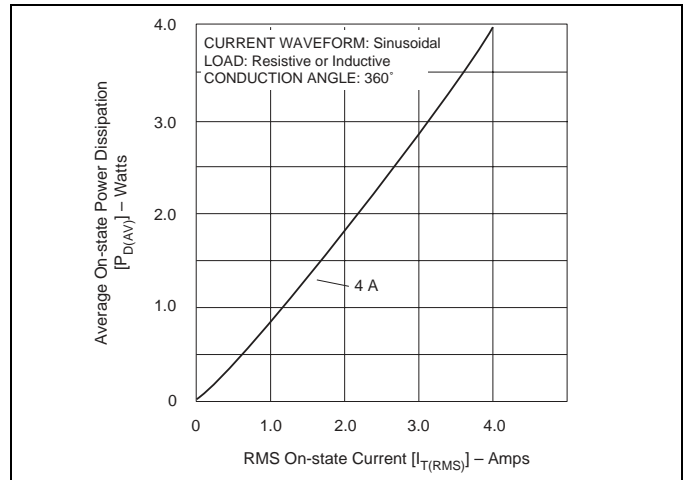

Figure E2.19 Power Dissipation (Typical) versus RMS On-state Current (4 A)

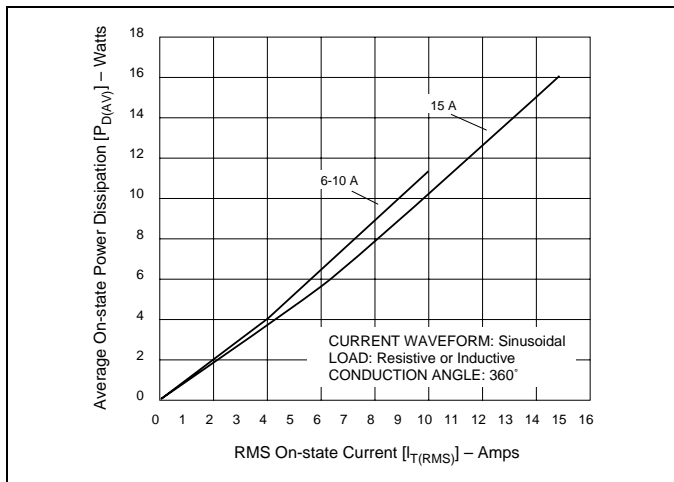

Figure E2.17 Power Dissipation (Typical) versus On-state Current (6 A to 10 A and 15 A)

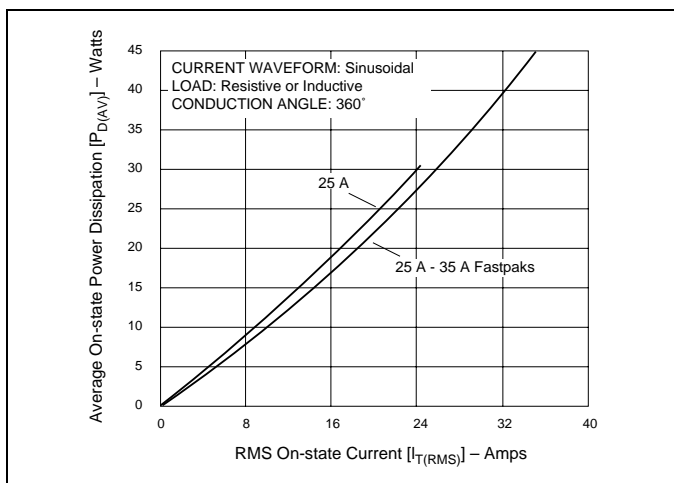

Figure E2.18 Power Dissipation (Typical) versus On-state Current (25 A to 35 A)