



5 dBic MultiBand Embedded GPS Active Antenna  
824-2,170 MHz UMCX Connector

Antennas Technical Data Sheet

PE51212

**Features**

- Highly efficient printed circuit board (PCB) design
- Designed for omni-directional applications
- Low profile, compact size
- IPEX, U.FL, UMCX compatible connector
- Integrated active GPS/GNSS Antenna

**Applications**

- Integrate into self-contained wireless equipment
- Embedded applications requiring integration flexibility
- Multiband cellular frequencies
- GPS/GNSS

**Description**

The PE51212 is a combination cellular and active GPS omnidirectional antenna designed to integrate into devices requiring wireless capability. It includes an integrated GPS/GNSS Antenna. By embedding these antennas directly into a device, the need for external antennas is eliminated. The omni-directional radiation pattern makes it ideal for multipoint and mobile wireless systems.

**Configuration**

Design	GPS Active
Application Band	Cellular  GPS
Band Type	Multi
Radiation Pattern	Omni Directional
Cable Type	1.13mm
Cable Length	3.937 in [100 mm]
Connector Type	UMCX Plug
Number of Ports	2

**Electrical Specifications**

Description	Minimum	Typical	Maximum	Units
Frequency Range	824		2,170	MHz
Gain		5		dBic

Click the following link (or enter part number in "SEARCH" on website) to obtain additional part information including price, inventory and certifications: [5 dBic MultiBand Embedded GPS Active Antenna 824-2,170 MHz UMCX Connector PE51212](#)



5 dBic MultiBand Embedded GPS Active Antenna  
824-2,170 MHz UMCX Connector

Antennas Technical Data Sheet

PE51212

		Port 1	Port 2	
Antenna	Frequencies (MHz)	1575.42-1602	824-960	1710-2200
	Polarization	RHCP	Vertical	Vertical
	Gain	5 dBic	2 dBi	3 dBi
	VSWR	<2.0:1	<2.5:1	<2.5:1
	Impedance	50 Ω		
	Axial Ratio		N/A	
LNA	Gain	28±2 dB	N/A	
	Noise Figure	<1.5		
	Filter Insertion Loss	<3 dB		
	Ex-band Attenuation	12dB@CF+50MHz/16dB@CF-50MHz		
	Supply Voltage	2.2~5 VDC		
	Current Consumption	5~15 mA		

**Mechanical Specifications**

**Size**

Overall Length	1.65354 in [42 mm]
Width	1.65354 in [42 mm]
Height	0.0393701 in [1 mm]

**Environmental Specifications**

**Temperature**

Operating Range	-40 to +85 deg C
Humidity	<75%
Vibration	10 to 55Hz with 1.5mm amplitude 2hours

**Compliance Certifications** (see [product page](#) for current document)

**Plotted and Other Data**

Notes:

Click the following link (or enter part number in "SEARCH" on website) to obtain additional part information including price, inventory and certifications: [5 dBic MultiBand Embedded GPS Active Antenna 824-2,170 MHz UMCX Connector PE51212](#)



5 dBic MultiBand Embedded GPS Active Antenna  
824-2,170 MHz UMCX Connector

Antennas Technical Data Sheet

PE51212

Typical Radiation Pattern

GSM Test - Pattern

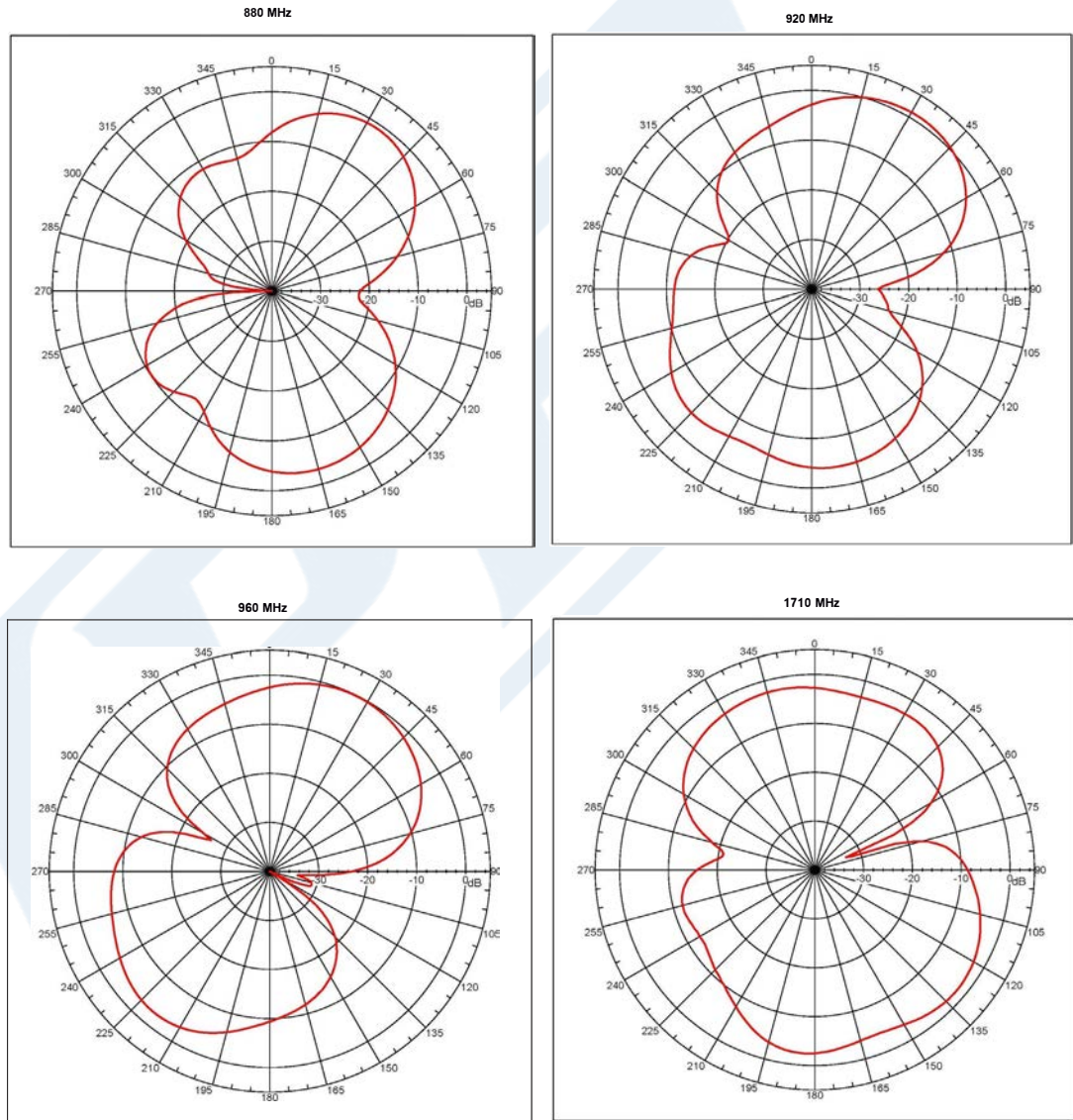

Click the following link (or enter part number in "SEARCH" on website) to obtain additional part information including price, inventory and certifications: [5 dBic MultiBand Embedded GPS Active Antenna 824-2,170 MHz UMCX Connector PE51212](#)



5 dBic MultiBand Embedded GPS Active Antenna  
824-2,170 MHz UMCX Connector

Antennas Technical Data Sheet

PE51212

GSM Test - Pattern

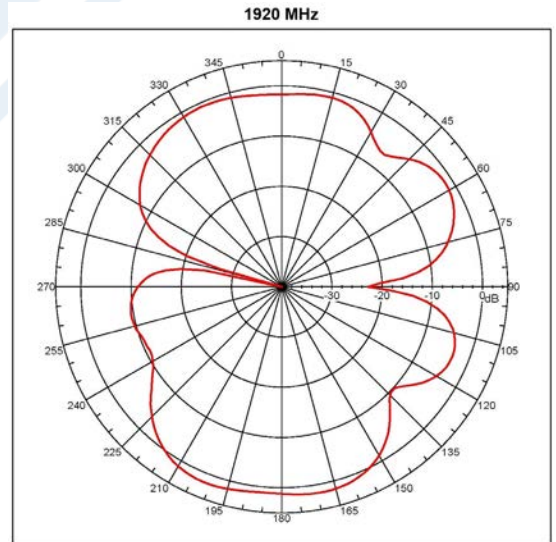
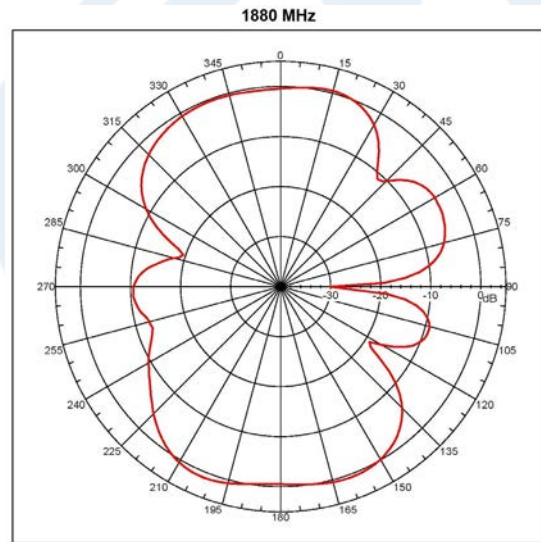
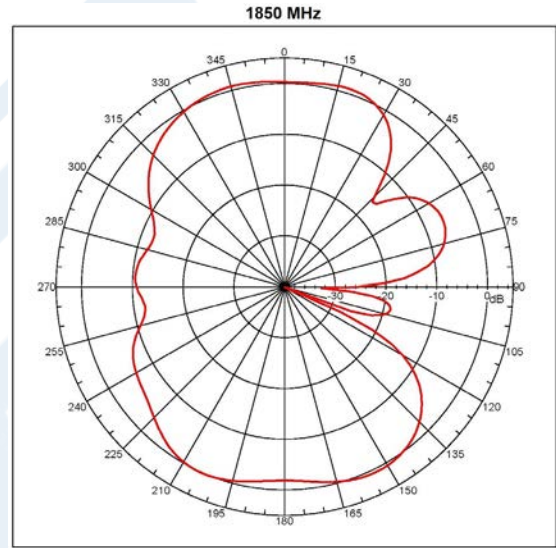
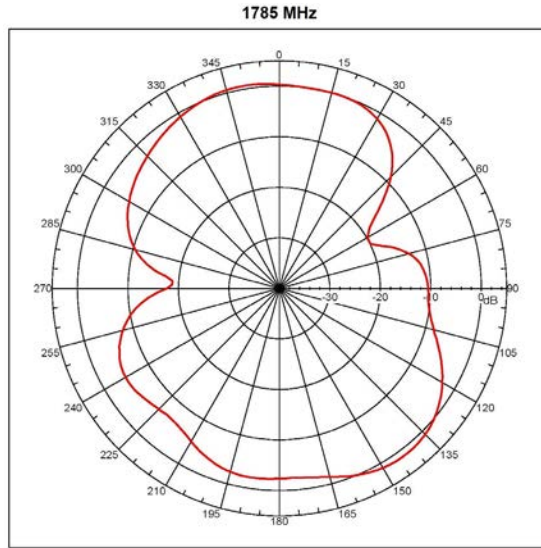

Click the following link (or enter part number in "SEARCH" on website) to obtain additional part information including price, inventory and certifications: [5 dBic MultiBand Embedded GPS Active Antenna 824-2,170 MHz UMCX Connector PE51212](#)





5 dBic MultiBand Embedded GPS Active Antenna  
824-2,170 MHz UMCX Connector

Antennas Technical Data Sheet

PE51212

**GSM Test - Pattern**

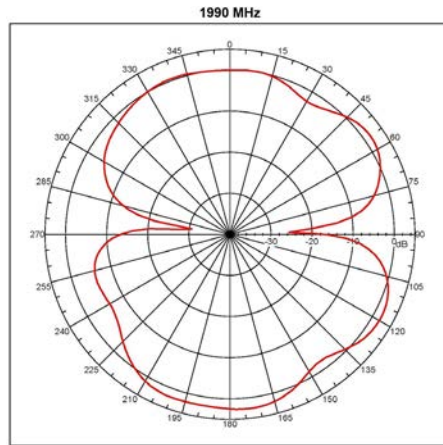

**GPS and GLONASSS**

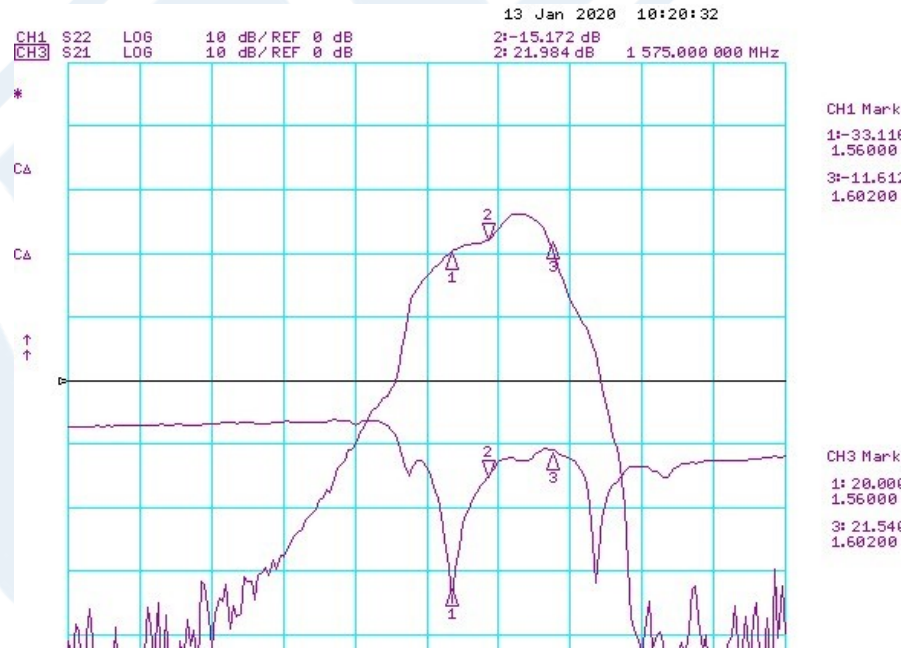

Click the following link (or enter part number in "SEARCH" on website) to obtain additional part information including price, inventory and certifications: [5 dBic MultiBand Embedded GPS Active Antenna 824-2,170 MHz UMCX Connector PE51212](#)



## 5 dBic MultiBand Embedded GPS Active Antenna 824-2,170 MHz UMCX Connector

### Antennas Technical Data Sheet

PE51212

5 dBic MultiBand Embedded GPS Active Antenna 824-2,170 MHz UMCX Connector from Pasternack Enterprises has same day shipment for domestic and International orders. Our RF, microwave and millimeter wave products maintain a 99.4% availability and are part of the broadest selection in the industry.

Click the following link (or enter part number in "SEARCH" on website) to obtain additional part information including price, inventory and certifications: [5 dBic MultiBand Embedded GPS Active Antenna 824-2,170 MHz UMCX Connector PE51212](https://www.pasternack.com/multi-antenna-824-mhz-2.17-ghz-5-dbic-gain-umcx-pe51212-p.aspx)

URL: <https://www.pasternack.com/multi-antenna-824-mhz-2.17-ghz-5-dbic-gain-umcx-pe51212-p.aspx>

The information contained in this document is accurate to the best of our knowledge and representative of the part described herein. It may be necessary to make modifications to the part and/or the documentation of the part, in order to implement improvements. Pasternack reserves the right to make such changes as required. Unless otherwise stated, all specifications are nominal. Pasternack does not make any representation or warranty regarding the suitability of the part described herein for any particular purpose, and Pasternack does not assume any liability arising out of the use of any part or documentation.

# PE51212 CAD Drawing

5 dBic MultiBand Embedded GPS Active Antenna 824-2,170 MHz UMCX Connector

REVISIONS			
REV.	DESCRIPTION	DATE	APPROVED
A	INITIAL RELEASE	06/18/2020	KHIETPAS

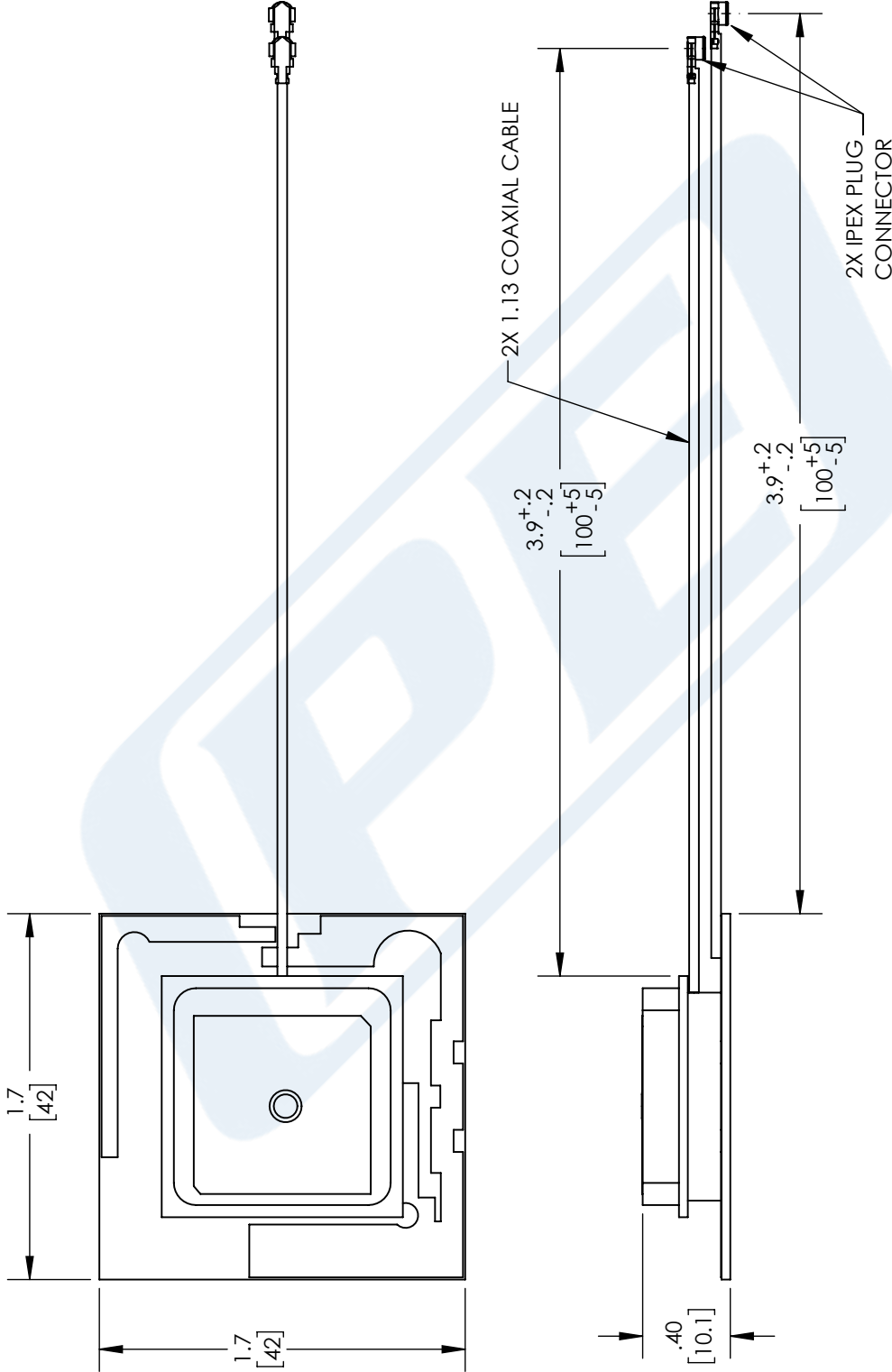

UNLESS OTHERWISE SPECIFIED LEADING DIMENSIONS ARE INCHES DIMENSIONS IN [ ] ARE MILLIMETERS

TOLERANCES:

.X = ±.2	[5.08]	FRACTIONS	
.XX = ±.02	[.51]		± 1/32
.XXX = ±.005	[.13]	ANGLES ± 1°	

CABLE LENGTH (L), TOLERANCES:

L ≤ 12	[305]	= +1 [25] / -0
12 [305] < L ≤ 60	[1524]	= +2 [51] / -0
60 [1524] < L ≤ 120	[3048]	= +4 [102] / -0
120 [3048] < L ≤ 300	[7620]	= +6 [152] / -0
300 [7620] < L		= +5%L / -0

ALL DIMENSIONS SHOWN ARE FOR REFERENCE ONLY.

**PE PASTERNAK**  
an INFINITI brand

Pasternack Enterprises, Inc.  
P. O. Box 16759, Irvine, CA 92623.  
Phone: 1.949.261.1920 | 1.866.727.8376  
Fax: 1.949.261.7451  
Website: www.pasternack.com  
E-mail: sales@pasternack.com

THIRD-ANGLE PROJECTION

THE INFORMATION AND DESIGN IN THIS DOCUMENT IS THE PROPERTY OF PASTERNAK CORPORATION ALL RIGHTS RESERVED.

SHEET 1 OF 1

SCALE N/A

REV A

ITEM NO. PE51212

DRAWN BY SLI

CAGE CODE A 53919