



Test Procedure for the NCP702MX33TCGEVB Evaluation Board

04-JUN-12

Test Setup 1:

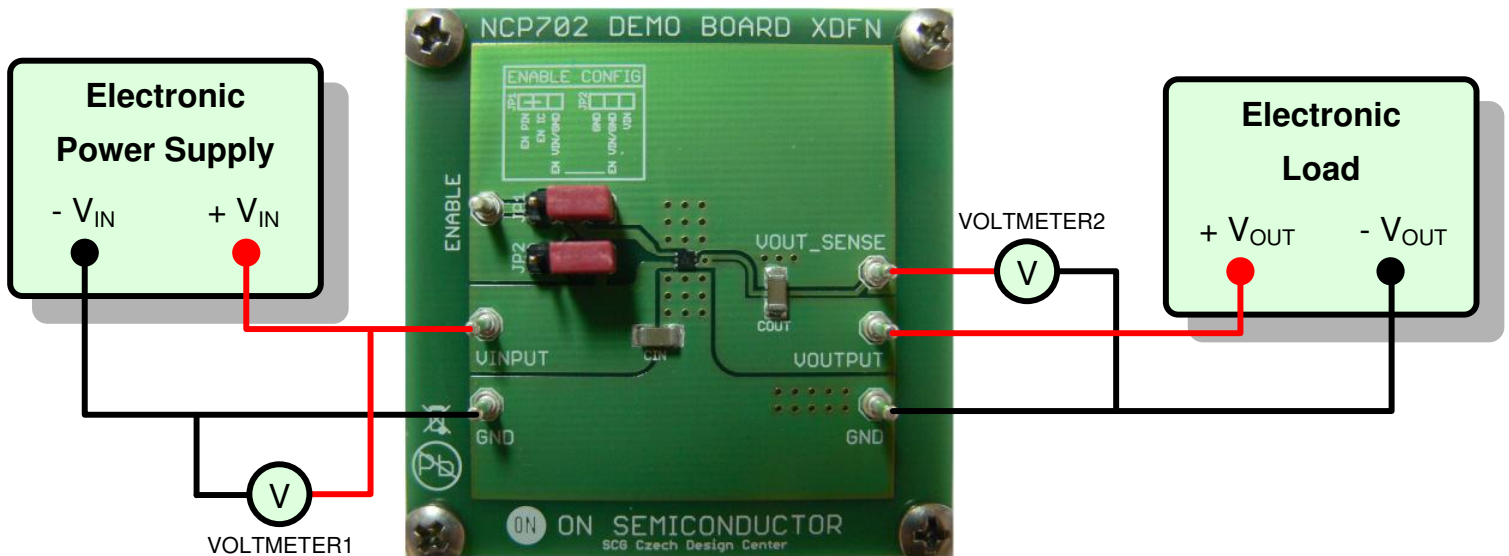

Figure 1. Test setup for the measurements of basic regulation characteristics

Required Equipment:

- 2 x Voltmeters
- DC Power Supply – Max. 5.5V
- Electronic Load



Test Procedure for the Measurement of Line Regulation parameter using Test Setup 1:

1. Connect the test setup as shown on Figure 1,
2. Set the electronic load for the required load current e.g. $I_{OUT} = 10\text{mA}$,
3. Apply the required minimum input voltage e.g. $V_{IN_MIN} = V_{OUT_NOM} + 0.3\text{V}^{(1)}$,
4. Note the output voltage reading V_{OUT1} indicated by VOTLMETER2,
5. Apply the required maximum input voltage e.g. $V_{IN_MAX} = V_{OUT_NOM} + 1.3\text{V}^{(1)}$,
6. Note the output voltage reading V_{OUT2} indicated by VOTLMETER2,
7. Calculate the Line Regulation parameter as:
$$\text{Reg}_{LINE} = (V_{OUT2} - V_{OUT1}) / (V_{IN_MAX} - V_{IN_MIN}) \text{ [V/V]}$$
8. Turn off the electronic load. Turn off the input power supply,
9. End of the test.

Test Procedure for the Measurement of Load Regulation parameter using Test Setup 1:

1. Connect the test setup as shown on Figure 1,
2. Set the electronic load for the required minimum output current e.g. $I_{OUT_MIN} = 1\text{mA}$,
3. Apply the desired input voltage e.g. $V_{IN} = V_{OUT_NOM} + 0.3\text{V}^{(1)}$,
4. Note the output voltage reading V_{OUT1} indicated by VOTLMETER2,
5. Set the electronic load for the required maximum output current e.g. $I_{OUT_MAX} = 150\text{mA}$,
6. Note the output voltage reading V_{OUT2} indicated by VOTLMETER2,
7. Calculate the Load Regulation parameter as:
$$\text{Reg}_{LOAD} = (V_{OUT2} - V_{OUT1}) / (I_{OUT_MAX} - I_{OUT_MIN}) \text{ [V/A]}$$
5. Turn off the electronic load. Turn off the input power supply,
6. End of the test.

⁽¹⁾ V_{OUT_NOM} is the nominal output voltage level of the regulator. NCP702 operating V_{IN} must be in the range $2.0\text{V} \leq V_{IN} \leq 5.5\text{V}$



Test Setup 2:

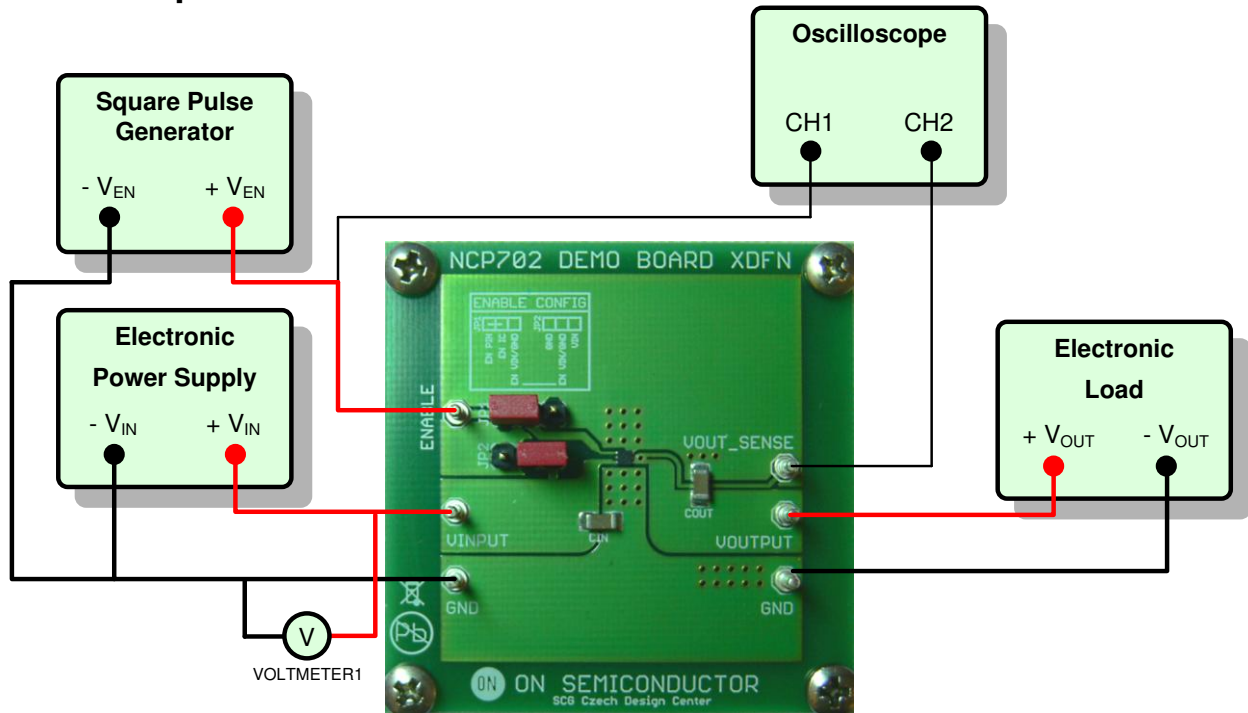

Figure 2. Test setup for the measurements of the Enable functionality

Required Equipment:

DC Power Supply – Max. 5.5V

Electronic Load, Voltmeter, Oscilloscope



Test Procedure for the measurements of the Enable functionality using Test Setup 2:

1. Connect the test setup as shown on Figure 2,
2. Apply the required input voltage e.g. $V_{IN} = V_{OUT_NOM} + 0.3V$ ⁽¹⁾
3. Set the electronic load for the required load current e.g. $I_{OUT} = 10mA$,
4. Set the square wave generator to generate the following pulse waveform:

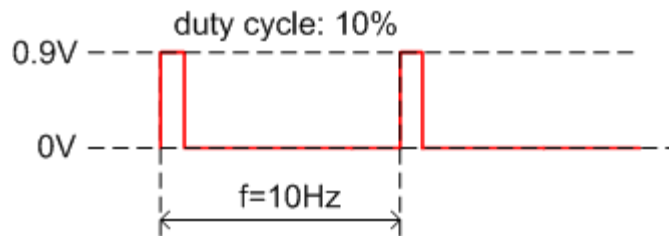

5. Verify with the oscilloscope that the output voltage V_{OUT} turns ON/OFF.
6. Turn off the pulse generator.
7. Turn off the electronic load.
8. Turn off the input power supply
9. End of the test

⁽¹⁾ V_{OUT_NOM} is the nominal output voltage level of the regulator. NCP702 operating V_{IN} must be in the range $2.0V \leq V_{IN} \leq 5.5V$



Test Setup 3:

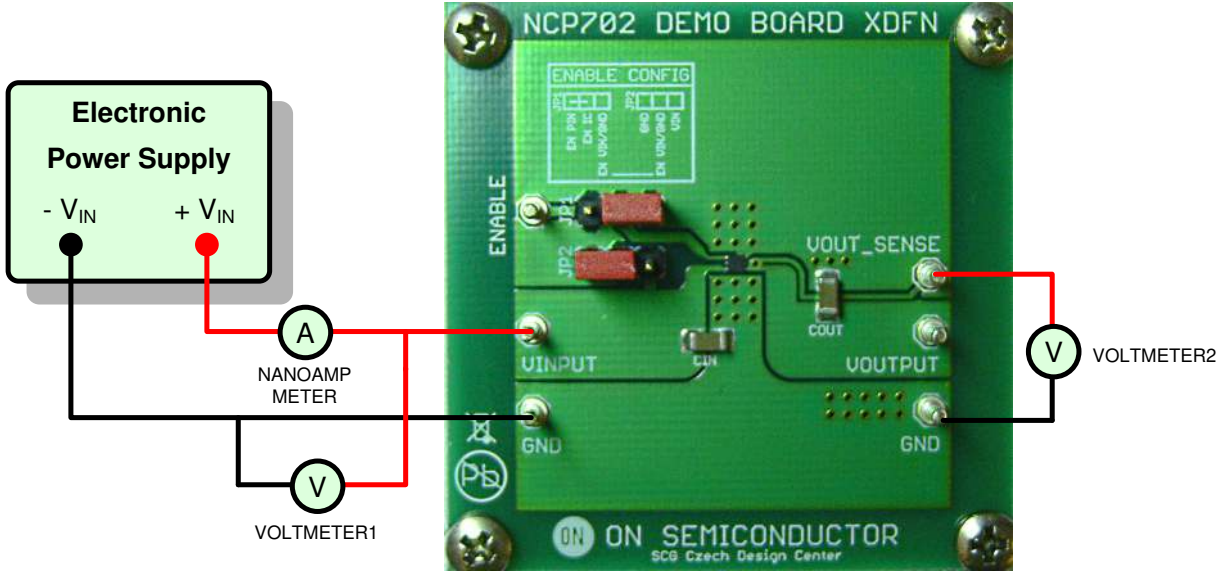

Figure 3. Test setup for the measurements of the disable current

Required Equipment:

- DC Power Supply – Max. 5.5V
- 2 x Voltmeter, Nanoampere meter



Test Procedure for the measurements of the disable current using Test Setup 3:

1. Connect the test setup as shown on Figure 3,
2. Apply the required input voltage e.g. so that Voltmeter1 indicates $V_{IN} = V_{OUT_NOM} + 0.3V$ ⁽¹⁾
3. Verify that the output voltage measured by Voltmeter2 is very close to 0V,
4. Read the disable current measured by the nanoampere meter.
5. Turn off the input power supply
6. End of the test

⁽¹⁾ V_{OUT_NOM} is the nominal output voltage level of the regulator. NCP702 operating V_{IN} must be in the range $2.0V \leq V_{IN} \leq 5.5V$.