

**Recommended P.C. Board Layout**  
SCALE 4:1

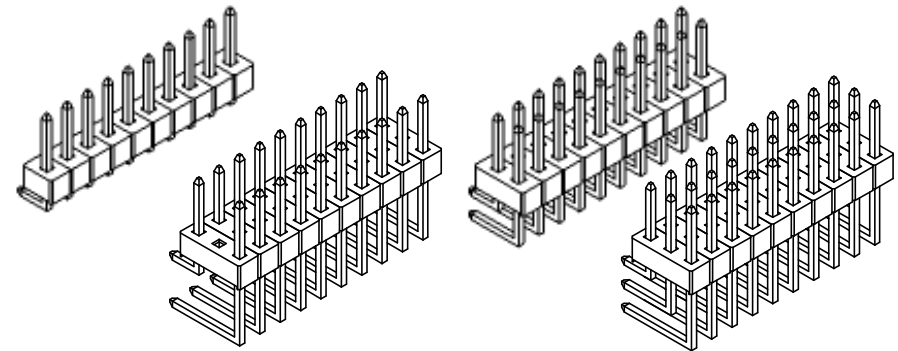
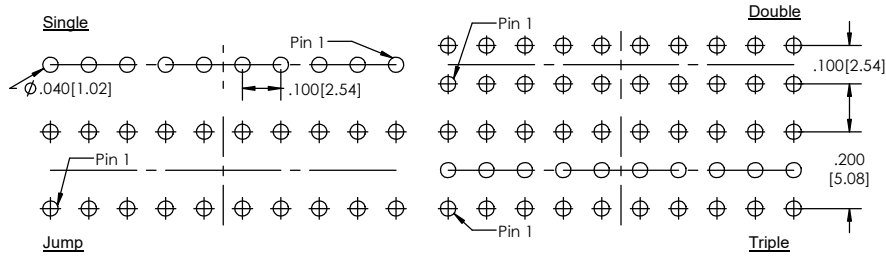

TSHR-1 **XX** - **X** - **XX** - **X** - **XX** - **XX** - **XXX** - **X** - **LF**  
**(A)** **(B)** **(C)** **(D)** **(E)** **(F)** **(G)** **(H)** **(I)**

- A. Pins Per Row  
- 1 through 40
- B. Row Specification  
- S= Single Row  
- D= Double Row  
- J= Jump Middle Row  
- T= Triple Row
- C. Pin Options  
- See Pin Options below
- D. Post Height  
- A= .230[5.84]  
- B= .318[8.08]
- E. Plating Options  
- See Plating Options below
- F. Lock Tight "LT" (Optional)  
- Leave blank if not needed  
- LT= With
- G. Polarized Position  
- Leave blank if not needed  
- If required, specify empty pin position  
- e.g. 012 for Pin 12
- H. Every Other Pin Filled (.200 Centers)  
- Leave blank if not needed  
- E= Filled
- I. Lead Free

Mates With:  
 BCSS SMBC  
 BSSH SSHQ  
 BSSHC SSHQR  
 BSSQ SSHR  
 BSSQC SSHS  
 BSSQM SSHSM  
 LBCSS  
 LSMBC  
 LSWSS

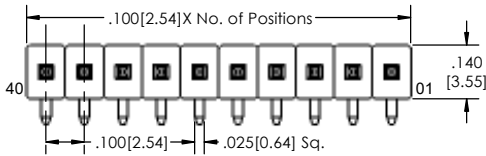
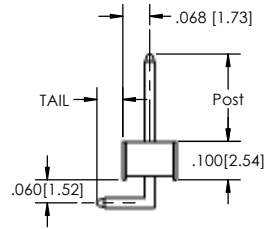

**SINGLE ROW**

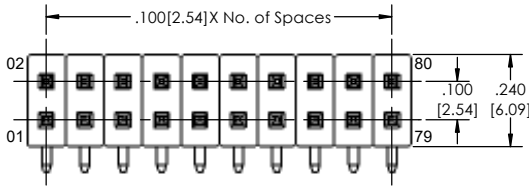
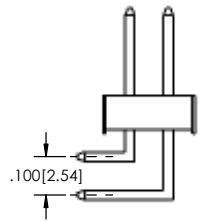

**DOUBLE ROW**

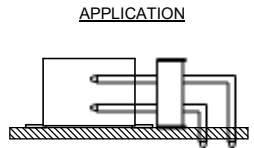

**APPLICATION**

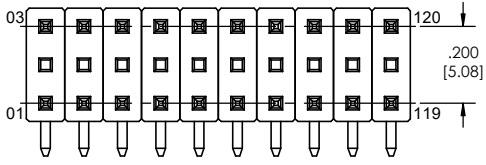
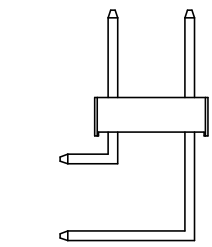

**JUMP MIDDLE ROW**

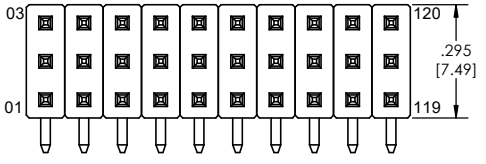
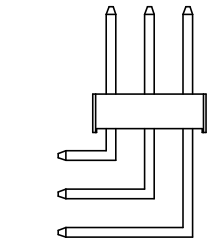

**TRIPLE ROW**

Plating options	
G	-10µ Gold on Contact Area/ Flash on Tail
T	-Matte Tin all Over
GT	-10µ Gold on Contact Area/ Matte Tin on Tail
H	-30µ Gold on Contact Area/ Matte Tin on Tail
F	-Gold Flash over Entire Pin
FT	-Gold Flash on Contact Area/ Matte Tin on Tail

**Specifications:**  
 Current Rating: 3.0 Ampere  
 Insulation Resistance: 1000M Ohms Min.  
 Dielectric Withstanding: 600V AC  
 Contact Resistance: 20M Ohms Max.  
 Operation Temperature: -40°C to +105°C  
 Max. Process Temperature  
 Peak: 260°C up to 20 secs.  
 Process: 230°C up to 60 secs.  
 Wave: 260°C up to 6 secs.  
 Manual Solder: 350°C up to 5 secs.

**Materials:**  
 Contact Material: Phosphor Bronze  
 Insulator Material: Nylon 6T  
 Plating: Au or Sn over 50µ" (1.27) Ni

Pin Options		
"A" Tail-.230 Post	"B" Tail-.318 Post	
.090[2.29mm]	N/A	02
.190[4.83mm]	.102[2.59mm]	04
.290[7.37mm]	.202[5.13mm]	06
.390[9.91mm]	.302[7.67mm]	08
.490[12.45mm]	.402[10.24mm]	10
.590[14.99mm]	.502[12.75mm]	12
.690[17.53mm]	.602[15.29mm]	14
.790[20.07mm]	.702[17.83mm]	16
.890[22.61mm]	.802[20.37mm]	18
.990[25.15mm]	.902[22.91mm]	20
1.090[27.69mm]	1.002[25.45mm]	22

Tails may be clipped to achieve specific dimensions.

Products cut to specific sizes are uncancelable/ nonreturnable.  
 Parts are subject to change without notice.

**ROHS COMPLIANT**

PROPRIETARY AND CONFIDENTIAL  
 THE INFORMATION CONTAINED IN THIS DRAWING IS THE SOLE PROPERTY OF Major League Electronics. ANY REPRODUCTION IN PART OR AS A WHOLE WITHOUT THE WRITTEN PERMISSION OF Major League Electronics IS PROHIBITED.

UNLESS OTHERWISE SPECIFIED:		NAME		DATE		
DIMENSIONS ARE IN INCHES		DRAWN	EWOW	01/14/14		
TOLERANCES: ONE DECIMAL ±.100 TWO DECIMAL ±.010 THREE DECIMAL ±.005 FOUR DECIMAL ±.002		CHECKED	GWE	01/14/14		
NEXT ASSY		USED ON	FINISH			
APPLICATION		DO NOT SCALE DRAWING		INTERPRET GEOMETRIC TOLERANCING PER:		ADDRESS:
				2533 Centennial Blvd. Jeffersville, In 47130 Phone: 812-670-4174 Fax: 812-670-4175 E-Mail: mle@mlelectronics.com		TITLE: TSHR-1 SERIES
				SIZE DWG. NO.		REV B
				SCALE 6:1		SHEET 1 OF 1