

TNC ATTENUATOR
4 DB 2 GHZ 2W

R412.504.000

Series : ATTENUATOR

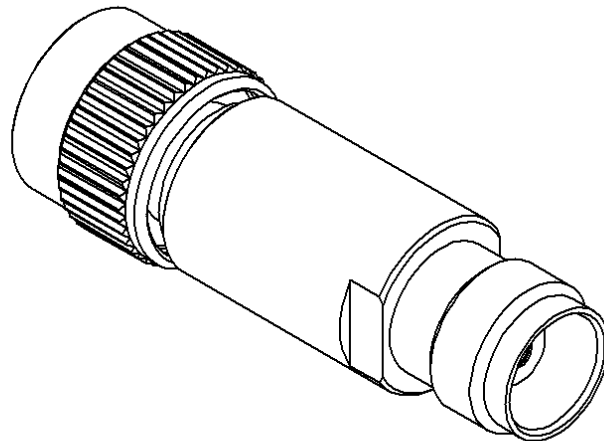
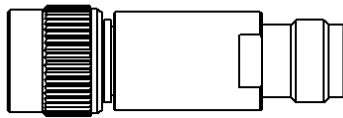
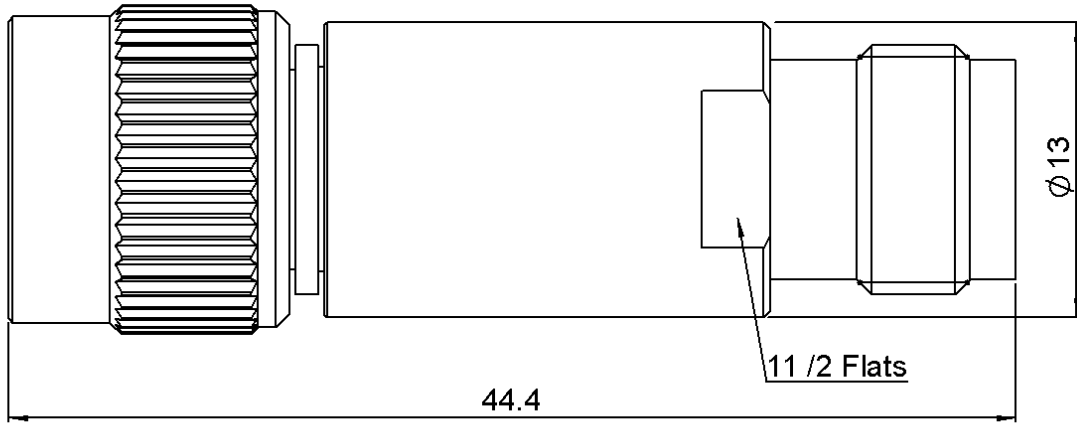

SCALE 1/1

All dimensions are in mm.

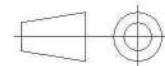

COMPONENTS	MATERIALS	PLATING(µm)
BODY	BRASS	NICKEL 5
MALE CENTER CONTACT	BERYLLIUM COPPER	GOLD 2.5 OVER NICKEL 1
FEMALE CENTER CONTACT	BERYLLIUM COPPER	GOLD 2.54 OVER NICKEL 1.27
OUTER CONTACT		
INSULATOR	PTFE	
GASKET	SILICONE RUBBER	
SUBSTRATE	ALUMINA	
RESISTOR	THIN FILM	
OTHERS PARTS		

Issue : 0835 B

In the effort to improve our products, we reserve the right to make changes judged to be necessary.



TNC ATTENUATOR
4 DB 2 GHZ 2W

R412.504.000
Series : ATTENUATOR

ELECTRICAL CHARACTERISTICS

Frequency (GHz)	DC - 2
V.S.W.R (≤)	1.15
Deviation(±dB)	0.35

Operating Frequency Range	DC - 2	GHz
Impedance	50	Ω
Nominal Attenuation	4	dB
Peak power at 25°C (1μs, 1%)	100	W
Average power at 25°C	2	W (Free Air Cooled)
		W (Conduction Cooled)

MECHANICAL CHARACTERISTICS

Connectors	TNC	Male Female	MIL-C 39012
Weight	31,8150 g		

ENVIRONMENTAL CHARACTERISTICS

Operating temperature range	-55 /+125 °C
Storage temperature range	-55 /+125 °C

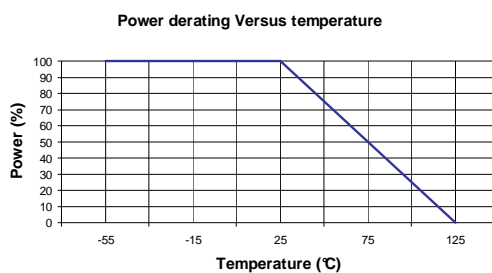

SPECIFICATION

OTHER CHARACTERISTICS

Issue : 0835 B

In the effort to improve our products, we reserve the right to make changes judged to be necessary.

