

## ISL8120EVAL4Z

### Evaluation Board Setup Procedure

AN1607  
Rev.2.00  
Jul 1, 2016

## Description

The [ISL8120](#) integrates two voltage-mode synchronous buck PWM controllers. It can be used either for dual independent outputs or a 2-phase single-output regulator.

The ISL8120EVAL4Z evaluation board is used for performance demo of 2/n-phase single-output applications. This application note introduces the setup procedure and performance of the ISL8120EVAL4Z evaluation board.

The ISL8120EVAL3Z evaluation board is for performance demo of dual independent outputs and DDR applications. Refer to application note [AN1528](#) "ISL8120EVAL3Z Evaluation Board Setup Procedure" for details of the ISL8120EVAL3Z board.

## References

- [ISL8120](#) datasheet

## Ordering Information

PART NUMBER	DESCRIPTION
ISL8120EVAL4Z	ISL8120EVAL4Z evaluation board

## Recommended Equipment

- 0V to 22V power supply with at least 20A source current capability, battery, or notebook AC adapter.
- Two electronic loads capable of sinking current up to 30A.
- Digital multimeters (DMMs).
- 100MHz quad-trace oscilloscope.

## Quick Start

1. Ensure that the circuit is correctly connected to the supply and loads prior to applying any power.
2. Adjust the input supply to be 12V. Turn on the input power supply.
3. Verify the output voltage is 1.2V. If PGOOD is set high, the LED2 will be green. If PGOOD is set low, the LED2 will be red. TP4 is the test post to monitor PGOOD.

## Circuits Description

J1 and J2 are the input power terminals.

J3 and J4 are output lugs for load connections.

The input electrolytic capacitors are used to handle the input current ripples.

Two upper and two lower Renesas "speed" series LFPK MOSFETs are used for each phase.

320nH PULSE surface mount inductors are used for each phase. Under the 500kHz setup, the inductor current peak-to-peak ripple is 7.5A at 12V input and 1.2V output.

Four SANYO POSCAP 2R5TPF470M7L (7mΩ) are used as output E-caps.

TP2 and TP3 are remote sense posts. These pins can be used to monitor and evaluate the system voltage regulations. If the user wants to use these test posts for remote sense, the  $R_{29}$  and  $R_{31}$  need to be changed to higher values, such as 10Ω. Also, the related voltage sense divider needs to be increased to a higher resistance, such as 1k.

TP1 is a test socket to hold the scope probe to check the output waveforms.

JP9 is used to disable the part.

JP6 is for connection of inputs of clock signal for the part to be synchronized with.

JP5 is used for connection of ISHARE signals of multiple boards in parallel operation applications.

JP3, JP4,  $R_{15}$  and  $R_{17}$  are used to set up the phase shift between the 2 phases of the IC.

$R_{27}$  is used to isolate the noise at PVCC caused by driving. In 3.3V applications, it is recommended to short  $R_{27}$  to 0 in order to prevent VCC from dropping below POR under low input voltage.

## Evaluating the Other Output Voltage

The ISL8120EVAL4Z kit output is preset to 1.2V/50A.  $V_{OUT1}$  can also be adjusted between 0.6V to 3V by changing the value of  $R_{26}$  and  $R_6$  for  $V_{OUT}$ , as given by [Equation 1](#). The same rule applies for  $V_{OUT2}$ .

$$R_{26} = \frac{R_6}{(V_{OUT}/V_{REF}) - 1} \quad \text{where } V_{REF} = 0.6V \quad (\text{EQ. 1})$$

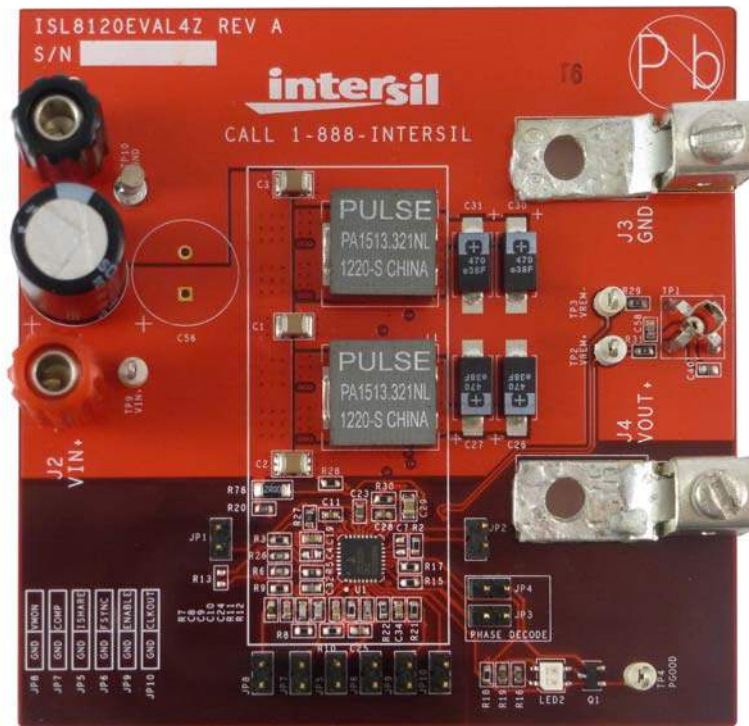

FIGURE 1. ISL8120EVAL4Z EVALUATION BOARD

## Programming the Input Voltage UVLO and its Hysteresis

By programming the voltage divider at the EN/FF pin connected to the input rail, the input UVLO and its hysteresis can be programmed. The ISL8120EVAL4Z has  $R_{20}$  4.32k and  $R_{21}$  1.62k; the IC will be disabled when input voltage drops below 2.94V and will restart until  $V_{IN}$  recovers to be above 3.2V.

For 12V applications, it is suggested to have  $R_{20}$  24.9k and  $R_{21}$  2.43k, of which the IC is disabled when the input voltage drops below 9V and will restart until  $V_{IN}$  recovers to be above 10.5V.

Refer to the [ISL8120](#) datasheet to program the UVLO falling threshold and hysteresis. The equations are restated here in [Equations 2](#) and [3](#), where  $R_{UP}$  and  $R_{DOWN}$  are the upper and lower resistors of the voltage divider at EN/FF pin,  $V_{HYS}$  is the desired UVLO hysteresis and  $V_{FTH}$  is the desired UVLO falling threshold.

$$R_{UP} = \frac{V_{HYS}}{I_{HYS}} \quad \text{where } I_{HYS} = 2 \times 30 \mu\text{A} \quad (\text{EQ. 2})$$

$$R_{DOWN} = \frac{R_{UP} \cdot V_{ENREF}}{V_{FTH} - V_{ENREF}} \quad \text{where } V_{ENREF} = 0.8\text{V} \quad (\text{EQ. 3})$$

Note the ISL8120 EN/FF pin is a triple function pin and the voltages applied to the EN/FF pins are also fed to adjust the amplitude of each channel's individual sawtooth.

## Parallel Operation for Current Sharing Application

The ISL8120 regulator outputs can be paralleled with current sharing control capability. The configuration for parallel operation is shown in Typical Application VIII in the datasheet. For this evaluation board, follow these steps to set up the parallel operation of 2 boards:

1. Change  $R_5$  to 100 $\Omega$  for both boards.
2. Use 2 wires (ISHARE, GND) connecting the ISHARE signals of the 2 boards through JP5.
3. Use 2 wires (EN/FF, GND) connecting the EN/FF signals of the 2 boards through JP9.
4. Use 2 wires connecting from JP10 (CLKOUT, GND) of one board to JP6 (FSYNC, GND) of another board.
5. Connecting the power supply to the inputs of the 2 boards.
6. Connecting the output of the 2 boards together and apply the loads.

[Figure 2](#) shows the setup picture of 2 boards in parallel operation.

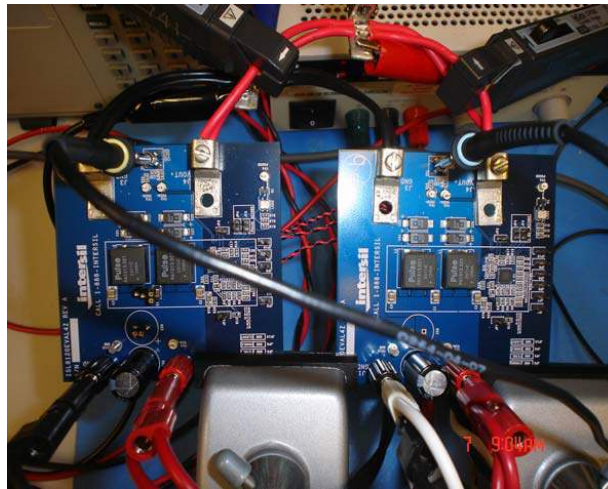
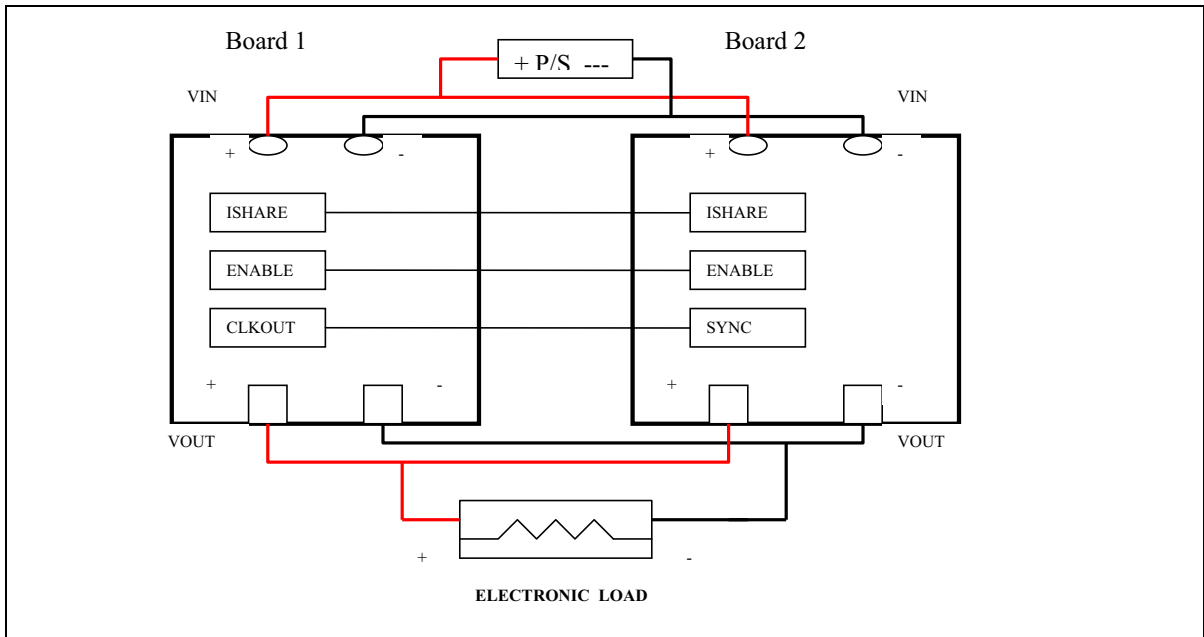
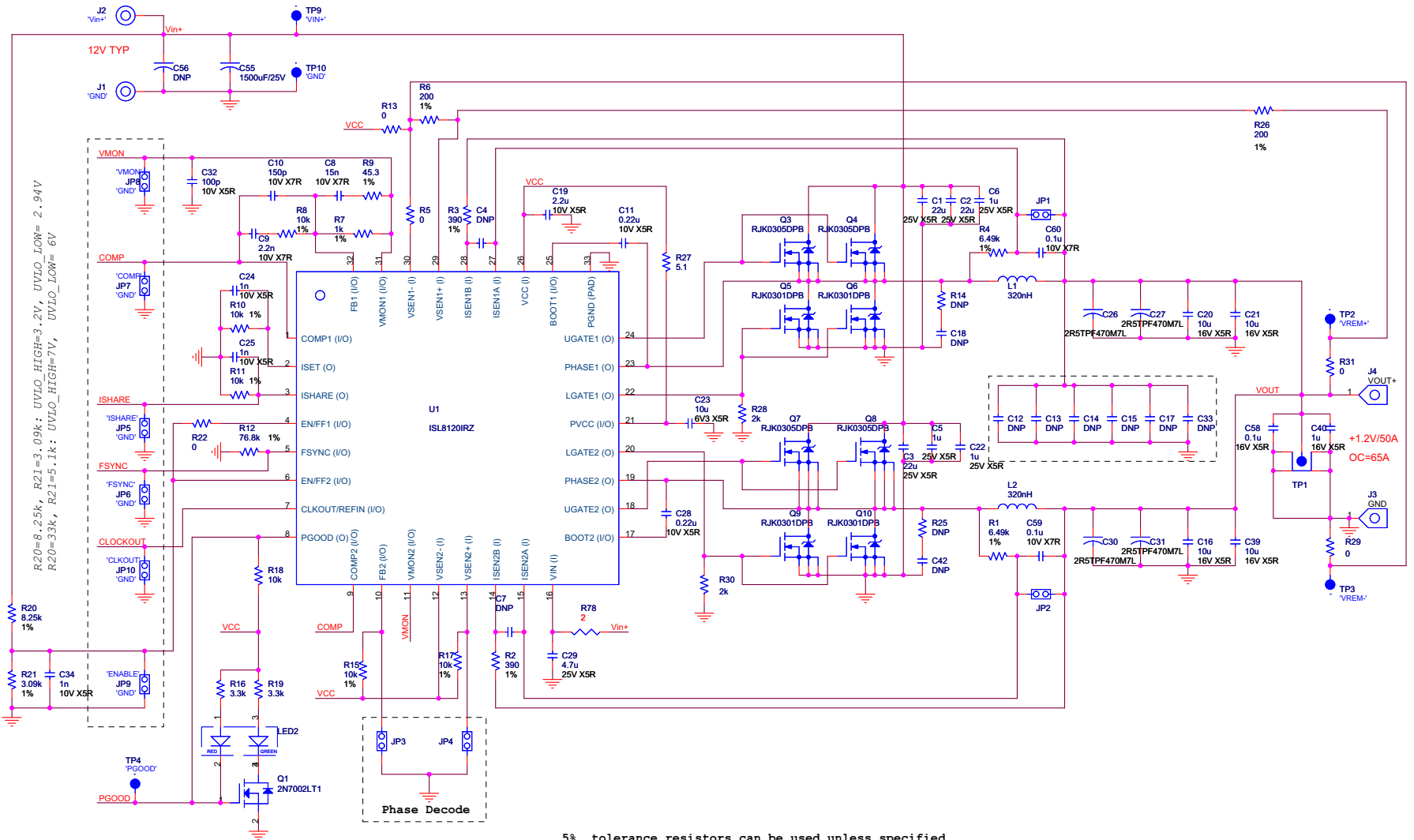

FIGURE 2. PARALLEL OPERATION SETUP

# ISL8120EVAL4Z Schematic



5% tolerance resistors can be used unless specified.

FIGURE 3. ISL8120EVAL4Z SCHEMATIC

## ISL8120EVAL4Z Bill of Materials

QTY	UNITS	REFERENCE DESIGNATOR	DESCRIPTION	MANUFACTURER	MANUFACTURER PART
1	ea		PWB-PCB, ISL8120EVAL4Z, REVA, QFN, ROHS	TBD	ISL8120EVAL4ZREVAPCB
1	ea	C32	CAP, SMD, 0603, 100pF, 50V, 5%, COG, ROHS	PANASONIC	ECJ-1VC1H101J
3	ea	C24, C25, C34	CAP, SMD, 0603, 1000pF, 16V, 10%, X7R, ROHS	VENKEL	C0603X7R160102KNE
3	ea	C58-C60	CAP, SMD, 0603, 0.1μF, 16V, 10%, X7R, ROHS	MURATA	GRM39X7R104K016AD
1	ea	C40	CAP, SMD, 0603, 1μF, 16V, 10%, X5R, ROHS	MURATA	GRM188R61C105KA12D
1	ea	C23	CAP, SMD, 0603, 10μF, 6.3V, 20%, X5R, ROHS	TDK	C1608X5R0J106M
1	ea	C10	CAP, SMD, 0603, 150pF, 50V, 5%, NP0, ROHS	PANASONIC	ECJ-1VC1H151J
1	ea	C8	CAP, SMD, 0603, 15000pF, 16V, 10%, X7R, ROHS	VENKEL	0603X7R160-153KNE
1	ea	C9	CAP, SMD, 0603, 2200pF, 50V, 5%, COG, ROHS	MURATA	GRM1885C1H222JA01D
2	ea	C11, C28	CAP, SMD, 0603, 0.22μF, 10V, 10%, X7R, ROHS	AVX	0603ZC224KAT2A
1	ea	C19	CAP, SMD, 0603, 2.2μF, 16V, 10%, X5R, ROHS	MURATA	GRM188R61C225KE15D
0	ea	C4, C7, C18, C42	CAP, SMD, 0603, DNP-PLACE HOLDER, ROHS		
3	ea	C5, C6, C22	CAP, SMD, 0805, 1.0μF, 25V, 10%, X5R, ROHS	AVX	08053C105KAT2A
1	ea	C29	CAP, SMD, 0805, 4.7μF, 25V, 10%, X5R, ROHS	MURATA	GRM21BR61E475KA12L
4	ea	C16, C20, C21, C39	CAP, SMD, 1206, 10μF, 16V, 10%, X5R, ROHS	VENKEL	C1206X5R160-106KNE(Pb-FREE)
3	ea	C1, C2, C3	CAP, SMD, 1210, 22μF, 25V, 10%, X5R, ROHS		
0	ea	C12, C13, C14, C15, C17, C33	CAP, SMD, 1210, DNP-PLACE HOLDER, ROHS		
1	ea	C55	CAP, RADIAL, 12.5x25, 1500μF, 25V, 20%, ALUM.ELEC., ROHS	RUBYCON	25ZL1500M12.5X25
0	ea	DNP (C56)	CAP, RADIAL, 12.5x25, 1500μF, 25V, 20%, ALUM.ELEC., ROHS	RUBYCON	25ZL1500M12.5X25
4	ea	C26, C27, C30, C31	CAP, POSCAP, SMD, 7.3x4.3, 470μF, 2.5V, 20%, 7mΩ, ROHS	SANYO	2R5TPF470M7L
2	ea	L1, L2	COIL-PWR INDUCTOR, SMD, 13mm, 320nH, 20%, 45A, Pb-Free	PULSE	PA1513.321NLT
1	ea	J2 (SEE ASSEMBLY INSTRUCTIONS)	CONN-GEN, BIND.POST, INSUL-RED, THMBNUT-GND	JOHNSON COMPONENTS	111-0702-001
1	ea	J1 (SEE ASSEMBLY INSTRUCTIONS)	CONN-GEN, BIND.POST, INSUL-BLK, THMBNUT-GND	JOHNSON COMPONENTS	111-0703-001
1	ea	TP1	CONN-SCOPE PROBE TEST PT, COMPACT, PCB MNT, ROHS	TEKTRONIX	131-5031-00
1	ea	TP10	CONN-TURRET, TERMINAL POST, TH, ROHS	KEYSTONE	1514-2
4	ea	TP2, TP3, TP4, TP9	CONN-COMPACT TEST PT, VERTICAL, WHT, ROHS	KEYSTONE	5007
10	ea	JP1-JP10	CONN-HEADER, 1x2, RETENTIVE, 2.54mm, 0.230x0.120, ROHS"	BERG/FCI	69190-202HLF
1	ea	LED2	LED, SMD, 3x2.5mm, 4P, RED/GREEN, 12/20MCD, 2V	LUMEX	SSL-LXA3025IGC-TR
1	ea	U1	IC-DUAL PHASE PWM CONTROLLER, 32P, QFN, 5x5, ROHS	INTERSIL	ISL8120IRZ

**ISL8120EVAL4Z Bill of Materials (Continued)**

QTY	UNITS	REFERENCE DESIGNATOR	DESCRIPTION	MANUFACTURER	MANUFACTURER PART
1	ea	Q1	TRANSISTOR, N-CHANNEL, 3LD, SOT-23, 60V, 115mA, ROHS	DIODES, INC.	2N7002-7-F
4	ea	Q5, Q6, Q9, Q10	TRANSISTOR, N-CHANNEL, 5P, LFAK, 30V, 60A, ROHS	RENESAS TECHNOLOGY	RJK0301DPB
4	ea	Q3, Q4, Q7, Q8	TRANSISTOR, N-CHANNEL, 5P, LFAK, 30V, 30A, ROHS	RENESAS TECHNOLOGY	RJK0305DPB
1	ea	R27	RES, SMD, 0603, 5.1Ω, 1/10W, 1%, TF, ROHS	VISHAY/DALE	CRCW06035R10FNEA
4	ea	R5, R22, R29, R31	RES, SMD, 0603, 0Ω, 1/10W, TF, ROHS	VENKEL	CR0603-10W-000T
1	ea	R7	RES, SMD, 0603, 1k, 1/10W, 1%, TF, ROHS	PANASONIC	ERJ-3EKF1001V
6	ea	R8, R10, R11, R15, R17, R18	RES, SMD, 0603, 10k, 1/10W, 1%, TF, ROHS	KOA	RK73H1JT1002F
1	ea	R21	RES, SMD, 0603, 1.62k, 1/10W, 1%, TF, ROHS	PANASONIC	ERJ-3EKF1621V
2	ea	R6, R26	RES, SMD, 0603, 200Ω, 1/10W, 1%, TF, ROHS	VENKEL	CR0603-10W-2000FT
2	ea	R28, R30	RES, SMD, 0603, 2k, 1/10W, 1%, TF, ROHS	KOA	RK73H1JT2001F
2	ea	R16, R19	RES, SMD, 0603, 3.3kΩ, 1/10W, 1%, TF, ROHS	ROHM	MCR03EZPF3301
2	ea	R2, R3	RES, SMD, 0603, 390Ω, 1/10W, 1%, TF, ROHS	PANASONIC	ERJ-3EKF3900V
1	ea	R20	RES, SMD, 0603, 4.32k, 1/10W, 1%, TF, ROHS		
1	ea	R9	RES, SMD, 0603, 45.3Ω, 1/10W, 1%, TF, ROHS	VENKEL	CR0603-10W-45R3FT
2	ea	R1, R4	RES, SMD, 0603, 6.49k, 1/10W, 1%, TF, ROHS	PANASONIC	ERJ-3EKF6491V
1	ea	R12	RES, SMD, 0603, 76.8k, 1/10W, 1%, TF, ROHS	VENKEL	CR0603-10W-7682FT
0	ea	R13	RES, SMD, 0603, DNP-PLACE HOLDER, ROHS		
0	ea	R14, R25	RES, SMD, 0805, DNP-PLACE HOLDER, ROHS		
1	ea	R78	RES, SMD, 1206, 2Ω, 1/4W, 1%, TF, ROHS	VENKEL	CR1206-4W-02R0
2	ea	J3, J4	HDWARE, MTG, CABLE TERMINAL, 6-14AWG, LUG&SCREW, ROHS	BERG/FCI	KPA8CTP
4	ea	Bottom four corners	BUMPONS, 0.44inW x 0.20inH, DOMETOP, , BLACK	3M	SJ-5003SPBL
1	ea	Place assy in bag	BAG, STATIC, 5x8, ZIPLOC, ROHS	INTERSIL	212403-013
1	ea	a) J1, J2 - Studs from binding posts	Instructions for assembly.	INTERSIL	ASSEMBLY INSTRUCTIONS
0	ea	b) Should be cut with with appropriate	Instructions for assembly.	INTERSIL	ASSEMBLY INSTRUCTIONS
0	ea	c) Cutters and de-burred with resin backed,	Instructions for assembly.	INTERSIL	ASSEMBLY INSTRUCTIONS
0	ea	d) Aluminum oxide sander.	Instructions for assembly.	INTERSIL	ASSEMBLY INSTRUCTIONS
1	ea		LABEL-FOR SERIAL NUMBER AND BOM REV #	INTERSIL	LABEL-SERIAL NUMBER

# ISL8120EVAL4Z Board Layout

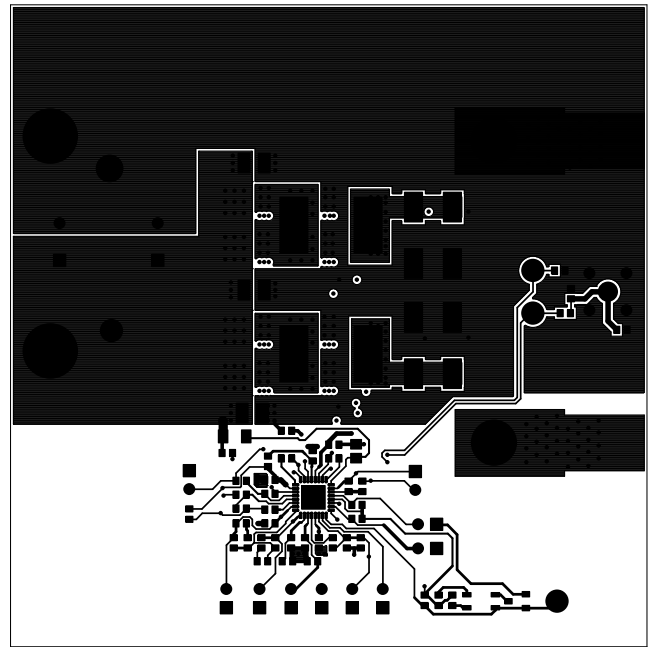
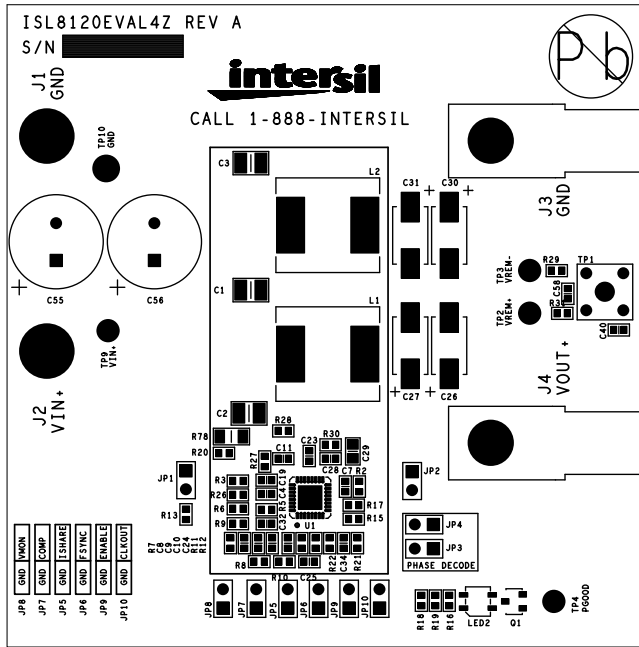

FIGURE 5. TOP LAYER

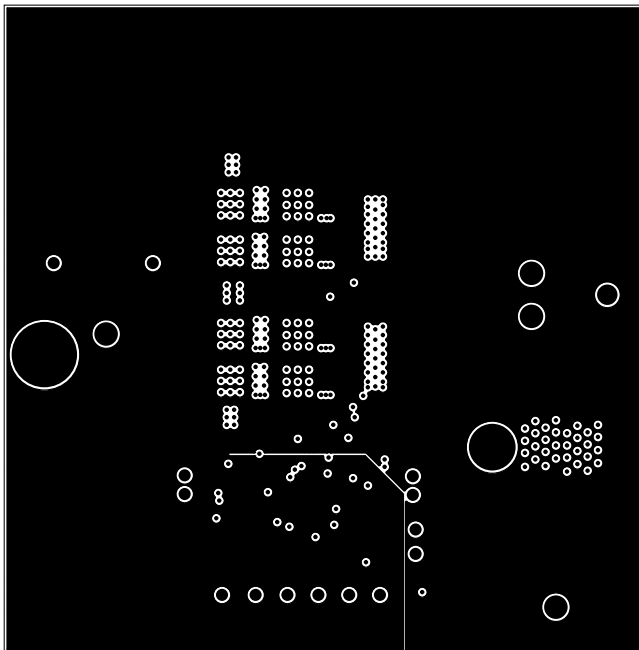

FIGURE 6. 2<sup>nd</sup> LAYER

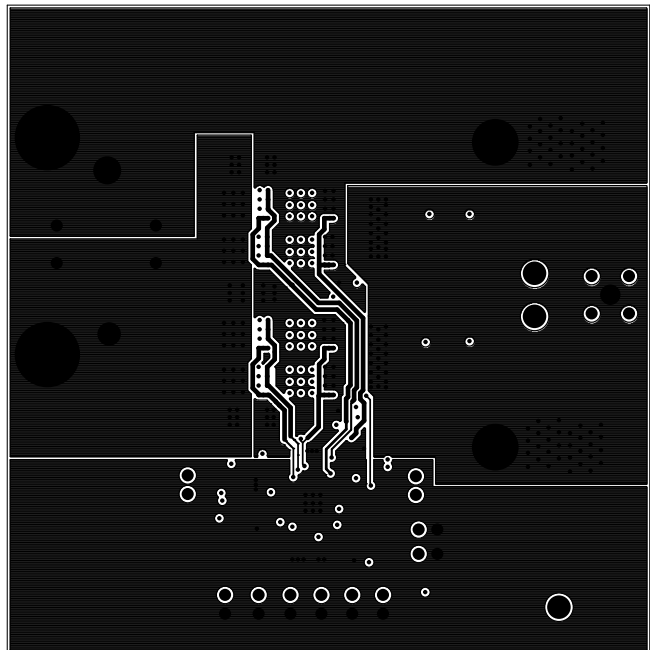

FIGURE 7. 3<sup>rd</sup> LAYER

**ISL8120EVAL4Z Board Layout** (Continued)

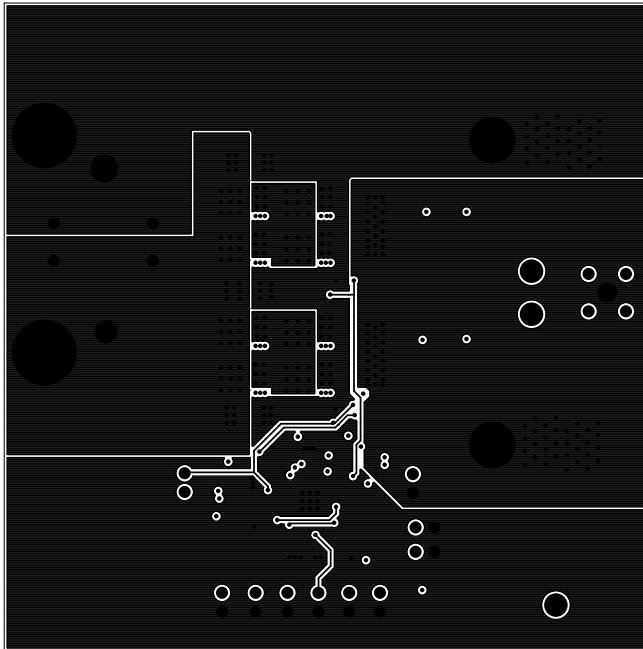

FIGURE 8. 4<sup>th</sup> LAYER

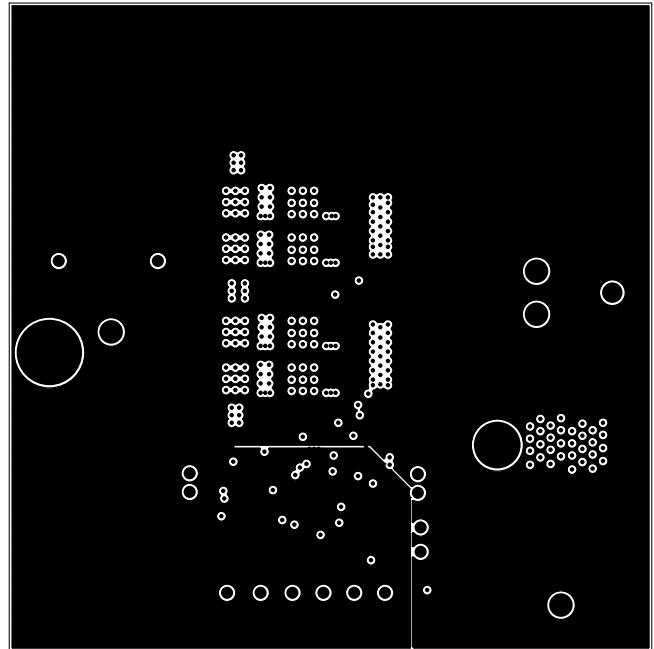

FIGURE 9. 5<sup>th</sup> LAYER

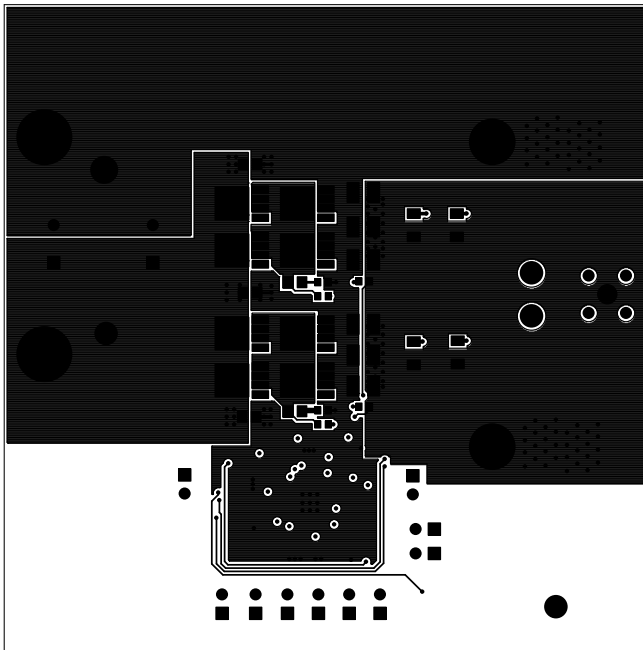

FIGURE 10. BOTTOM LAYER

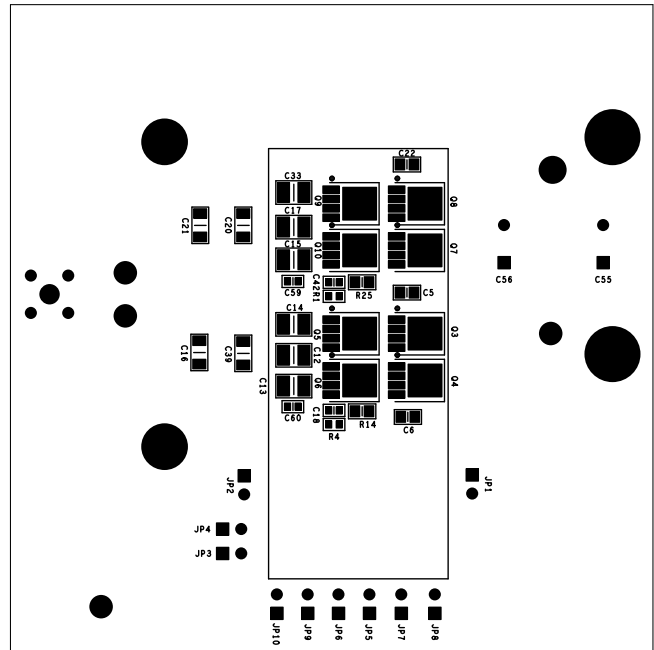

FIGURE 11. BOTTOM SILKSCREEN (MIRRORED)



# ISL8120EVAL4Z Board Layout (Continued)

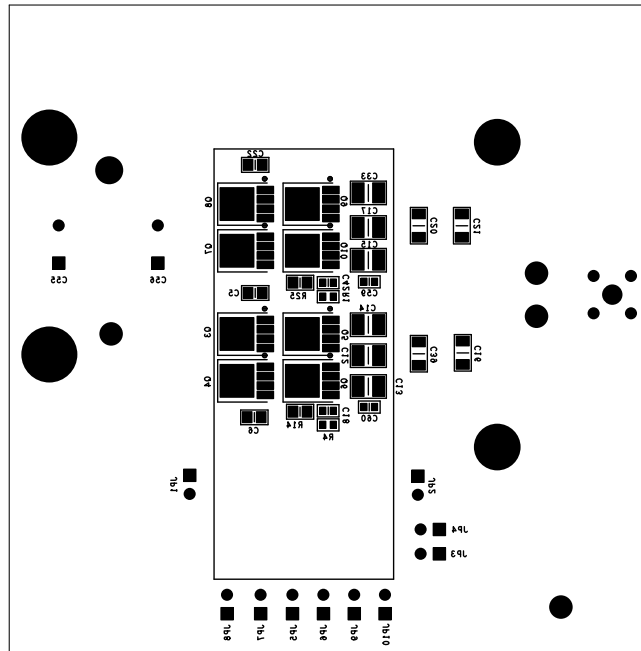

FIGURE 12. BOTTOM SILKSCREEN

# Test Data for ISL8120EVAL4Z

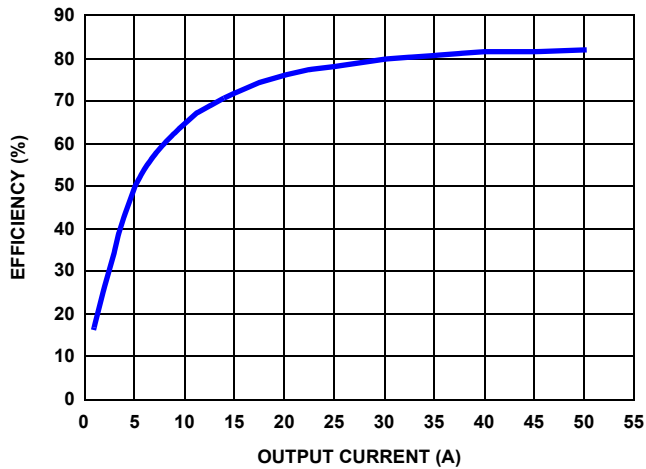

FIGURE 13. EFFICIENCY (12V  $V_{IN}$  AND 1.2V  $V_{OUT}$ )

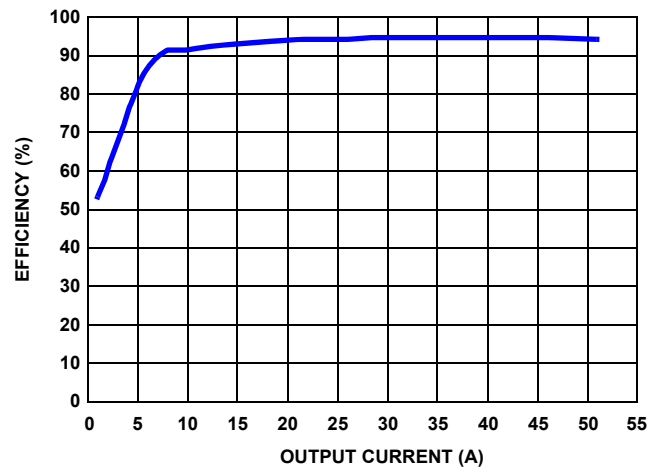

FIGURE 14. EFFICIENCY (12V  $V_{IN}$  AND 3.3V  $V_{OUT}$ )

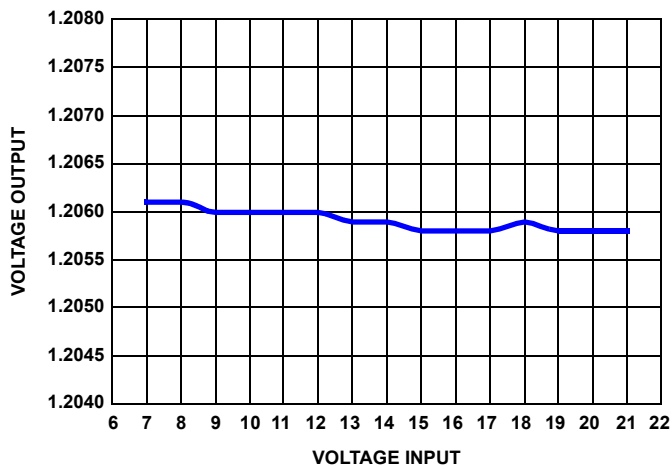

FIGURE 15. LINE REGULATION

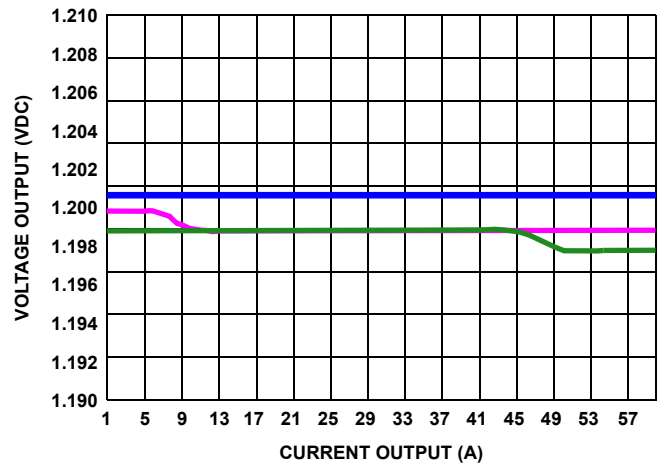

FIGURE 16. LOAD REGULATION

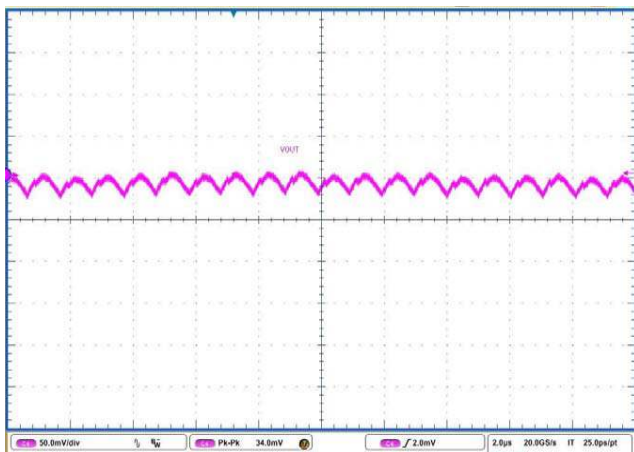

FIGURE 17. OUTPUTS RIPPLE UNDER 0A LOAD

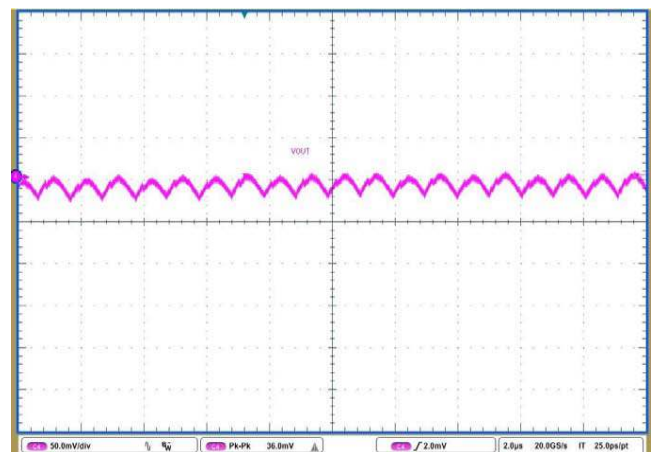
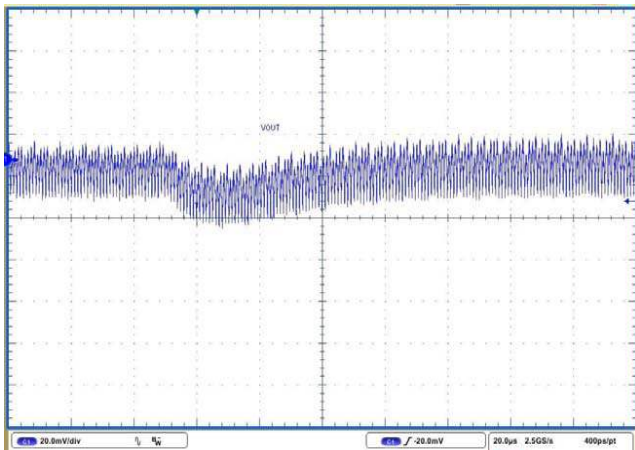
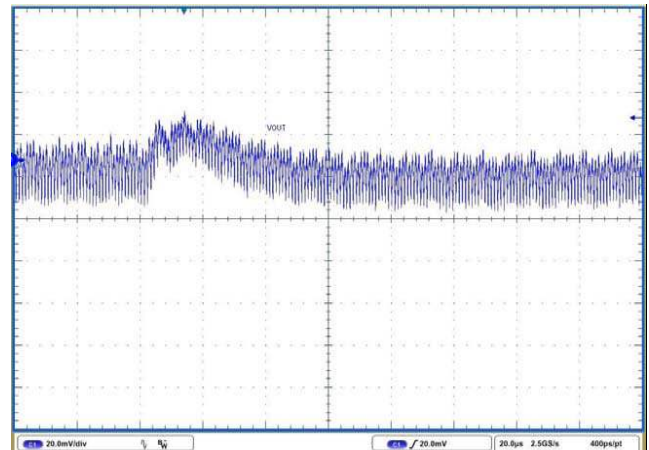

FIGURE 18. OUTPUTS RIPPLE UNDER 50A LOAD

**Test Data for ISL8120EVAL4Z (Continued)**



**FIGURE 19. LOAD TRANSIENT (0A TO 50A STEP, SLEW\_RATE = 2.5A/µs)**



**FIGURE 20. LOAD TRANSIENT (50A TO 0A STEP, SLEW\_RATE = 2.5A/µs)**

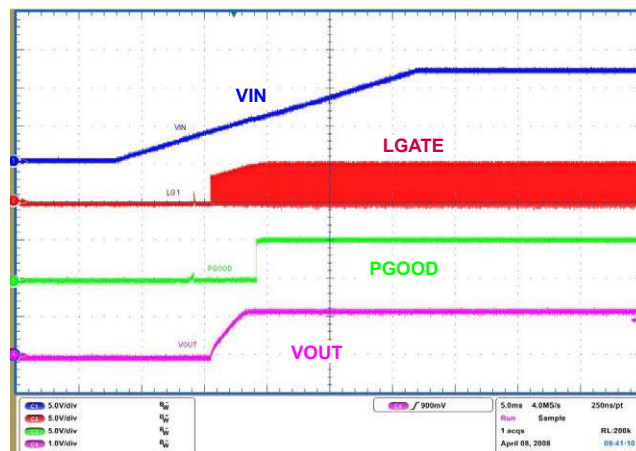

**FIGURE 21. POWER-UP UNDER 50A FULL LOAD**

## Notice

1. Descriptions of circuits, software and other related information in this document are provided only to illustrate the operation of semiconductor products and application examples. You are fully responsible for the incorporation or any other use of the circuits, software, and information in the design of your product or system. Renesas Electronics disclaims any and all liability for any losses and damages incurred by you or third parties arising from the use of these circuits, software, or information.
2. Renesas Electronics hereby expressly disclaims any warranties against and liability for infringement or any other claims involving patents, copyrights, or other intellectual property rights of third parties, by or arising from the use of Renesas Electronics products or technical information described in this document, including but not limited to, the product data, drawings, charts, programs, algorithms, and application examples.
3. No license, express, implied or otherwise, is granted hereby under any patents, copyrights or other intellectual property rights of Renesas Electronics or others.
4. You shall not alter, modify, copy, or reverse engineer any Renesas Electronics product, whether in whole or in part. Renesas Electronics disclaims any and all liability for any losses or damages incurred by you or third parties arising from such alteration, modification, copying or reverse engineering.
5. Renesas Electronics products are classified according to the following two quality grades: "Standard" and "High Quality". The intended applications for each Renesas Electronics product depends on the product's quality grade, as indicated below.  
"Standard": Computers; office equipment; communications equipment; test and measurement equipment; audio and visual equipment; home electronic appliances; machine tools; personal electronic equipment; industrial robots; etc.  
"High Quality": Transportation equipment (automobiles, trains, ships, etc.); traffic control (traffic lights); large-scale communication equipment; key financial terminal systems; safety control equipment; etc.  
Unless expressly designated as a high reliability product or a product for harsh environments in a Renesas Electronics data sheet or other Renesas Electronics document, Renesas Electronics products are not intended or authorized for use in products or systems that may pose a direct threat to human life or bodily injury (artificial life support devices or systems; surgical implantations; etc.), or may cause serious property damage (space system; undersea repeaters; nuclear power control systems; aircraft control systems; key plant systems; military equipment; etc.). Renesas Electronics disclaims any and all liability for any damages or losses incurred by you or any third parties arising from the use of any Renesas Electronics product that is inconsistent with any Renesas Electronics data sheet, user's manual or other Renesas Electronics document.
6. When using Renesas Electronics products, refer to the latest product information (data sheets, user's manuals, application notes, "General Notes for Handling and Using Semiconductor Devices" in the reliability handbook, etc.), and ensure that usage conditions are within the ranges specified by Renesas Electronics with respect to maximum ratings, operating power supply voltage range, heat dissipation characteristics, installation, etc. Renesas Electronics disclaims any and all liability for any malfunctions, failure or accident arising out of the use of Renesas Electronics products outside of such specified ranges.
7. Although Renesas Electronics endeavors to improve the quality and reliability of Renesas Electronics products, semiconductor products have specific characteristics, such as the occurrence of failure at a certain rate and malfunctions under certain use conditions. Unless designated as a high reliability product or a product for harsh environments in a Renesas Electronics data sheet or other Renesas Electronics document, Renesas Electronics products are not subject to radiation resistance design. You are responsible for implementing safety measures to guard against the possibility of bodily injury, injury or damage caused by fire, and/or danger to the public in the event of a failure or malfunction of Renesas Electronics products, such as safety design for hardware and software, including but not limited to redundancy, fire control and malfunction prevention, appropriate treatment for aging degradation or any other appropriate measures. Because the evaluation of microcomputer software alone is very difficult and impractical, you are responsible for evaluating the safety of the final products or systems manufactured by you.
8. Please contact a Renesas Electronics sales office for details as to environmental matters such as the environmental compatibility of each Renesas Electronics product. You are responsible for carefully and sufficiently investigating applicable laws and regulations that regulate the inclusion or use of controlled substances, including without limitation, the EU RoHS Directive, and using Renesas Electronics products in compliance with all these applicable laws and regulations. Renesas Electronics disclaims any and all liability for damages or losses occurring as a result of your noncompliance with applicable laws and regulations.
9. Renesas Electronics products and technologies shall not be used for or incorporated into any products or systems whose manufacture, use, or sale is prohibited under any applicable domestic or foreign laws or regulations. You shall comply with any applicable export control laws and regulations promulgated and administered by the governments of any countries asserting jurisdiction over the parties or transactions.
10. It is the responsibility of the buyer or distributor of Renesas Electronics products, or any other party who distributes, disposes of, or otherwise sells or transfers the product to a third party, to notify such third party in advance of the contents and conditions set forth in this document.
11. This document shall not be reprinted, reproduced or duplicated in any form, in whole or in part, without prior written consent of Renesas Electronics.
12. Please contact a Renesas Electronics sales office if you have any questions regarding the information contained in this document or Renesas Electronics products.  
(Note 1) "Renesas Electronics" as used in this document means Renesas Electronics Corporation and also includes its directly or indirectly controlled subsidiaries.  
(Note 2) "Renesas Electronics product(s)" means any product developed or manufactured by or for Renesas Electronics.

(Rev.4.0-1 November 2017)



### SALES OFFICES

Renesas Electronics Corporation

<http://www.renesas.com>

Refer to "<http://www.renesas.com/>" for the latest and detailed information.

**Renesas Electronics America Inc.**  
1001 Murphy Ranch Road, Milpitas, CA 95035, U.S.A.  
Tel: +1-408-432-8888, Fax: +1-408-434-5351

**Renesas Electronics Canada Limited**  
9251 Yonge Street, Suite 8309 Richmond Hill, Ontario Canada L4C 9T3  
Tel: +1-905-237-2004

**Renesas Electronics Europe Limited**  
Dukes Meadow, Millboard Road, Bourne End, Buckinghamshire, SL8 5FH, U.K  
Tel: +44-1628-651-700, Fax: +44-1628-651-804

**Renesas Electronics Europe GmbH**  
Arcadiastrasse 10, 40472 Düsseldorf, Germany  
Tel: +49-211-6503-0, Fax: +49-211-6503-1327

**Renesas Electronics (China) Co., Ltd.**  
Room 1709 Quantum Plaza, No.27 ZhichunLu, Haidian District, Beijing, 100191 P. R. China  
Tel: +86-10-8235-1155, Fax: +86-10-8235-7679

**Renesas Electronics (Shanghai) Co., Ltd.**  
Unit 301, Tower A, Central Towers, 555 Langao Road, Putuo District, Shanghai, 200333 P. R. China  
Tel: +86-21-2226-0888, Fax: +86-21-2226-0999

**Renesas Electronics Hong Kong Limited**  
Unit 1601-1611, 16/F., Tower 2, Grand Century Place, 193 Prince Edward Road West, Mongkok, Kowloon, Hong Kong  
Tel: +852-2265-6688, Fax: +852-2886-9022

**Renesas Electronics Taiwan Co., Ltd.**  
13F, No. 363, Fu Shing North Road, Taipei 10543, Taiwan  
Tel: +886-2-8175-9600, Fax: +886-2-8175-9670

**Renesas Electronics Singapore Pte. Ltd.**  
80 Bendemeer Road, Unit #06-02 Hyflux Innovation Centre, Singapore 339949  
Tel: +65-6213-0200, Fax: +65-6213-0300

**Renesas Electronics Malaysia Sdn.Bhd.**  
Unit 1207, Block B, Menara Amcorp, Amcorp Trade Centre, No. 18, Jln Persiaran Barat, 46050 Petaling Jaya, Selangor Darul Ehsan, Malaysia  
Tel: +60-3-7955-9390, Fax: +60-3-7955-9510

**Renesas Electronics India Pvt. Ltd.**  
No.777C, 100 Feet Road, HAL 2nd Stage, Indiranagar, Bangalore 560 038, India  
Tel: +91-80-67208700, Fax: +91-80-67208777

**Renesas Electronics Korea Co., Ltd.**  
17F, KAMCO Yangjae Tower, 262, Gangnam-daero, Gangnam-gu, Seoul, 06265 Korea  
Tel: +82-2-558-3737, Fax: +82-2-558-5338