

4

3

2

1

THIS DRAWING IS UNPUBLISHED. RELEASED FOR PUBLICATION
© COPYRIGHT ALL RIGHTS RESERVED.

LOC	DIST	REVISIONS			
P	LTR	DESCRIPTION	DATE	DWN	APVD
	D1	ECR-16-009824	28JUL2016	GK	SD

REPLACED BY OCEAN STYLE APPLICATOR PART NUMBER 2836284-1

FOR REPLACEMENT PARTS FOR APPLICATOR 466441-5
REFER TO ADDITIONAL PAGE(S). SPARE PARTS KIT (IF LISTED)
WILL REMAIN AVAILABLE.

THE REPLACEMENT OCEAN STYLE APPLICATOR HAS THE
SAME TERMINATOR/PRESS INTERFACE AS APPLICATOR
466441-5

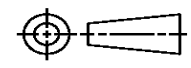
THIS DRAWING IS A CONTROLLED DOCUMENT.		DWN	GOPALAKRISHNA HV		 TE Connectivity		
DIMENSIONS:		CHK	GOPALAKRISHNA HV				
		TOLERANCES UNLESS OTHERWISE SPECIFIED:		APVD	NAME		
		0 PLC ± 1 PLC ± 2 PLC ± 3 PLC ± 4 PLC ± ANGLES ±		STOUGH DALE	MINIATURE QUICK CHANGE APPLICATOR SIDE FEED FASTON TAB		
MATERIAL	FINISH	PRODUCT SPEC	APPLICATION SPEC	SIZE	CAGE CODE	DRAWING NO	RESTRICTED TO
		WEIGHT		A3		©- 466441-5	
CUSTOMER DRAWING			SCALE	SHEET 1 OF 2	REV D1		

THIS IS A CONTROLLED DOCUMENT.

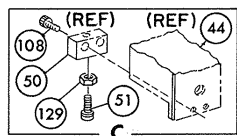
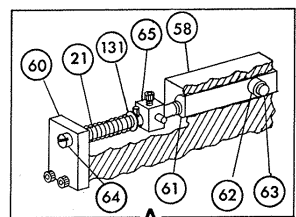

PRE-FEED 1 1/8" STROKE
POST-FEED 1 5/8" STROKE

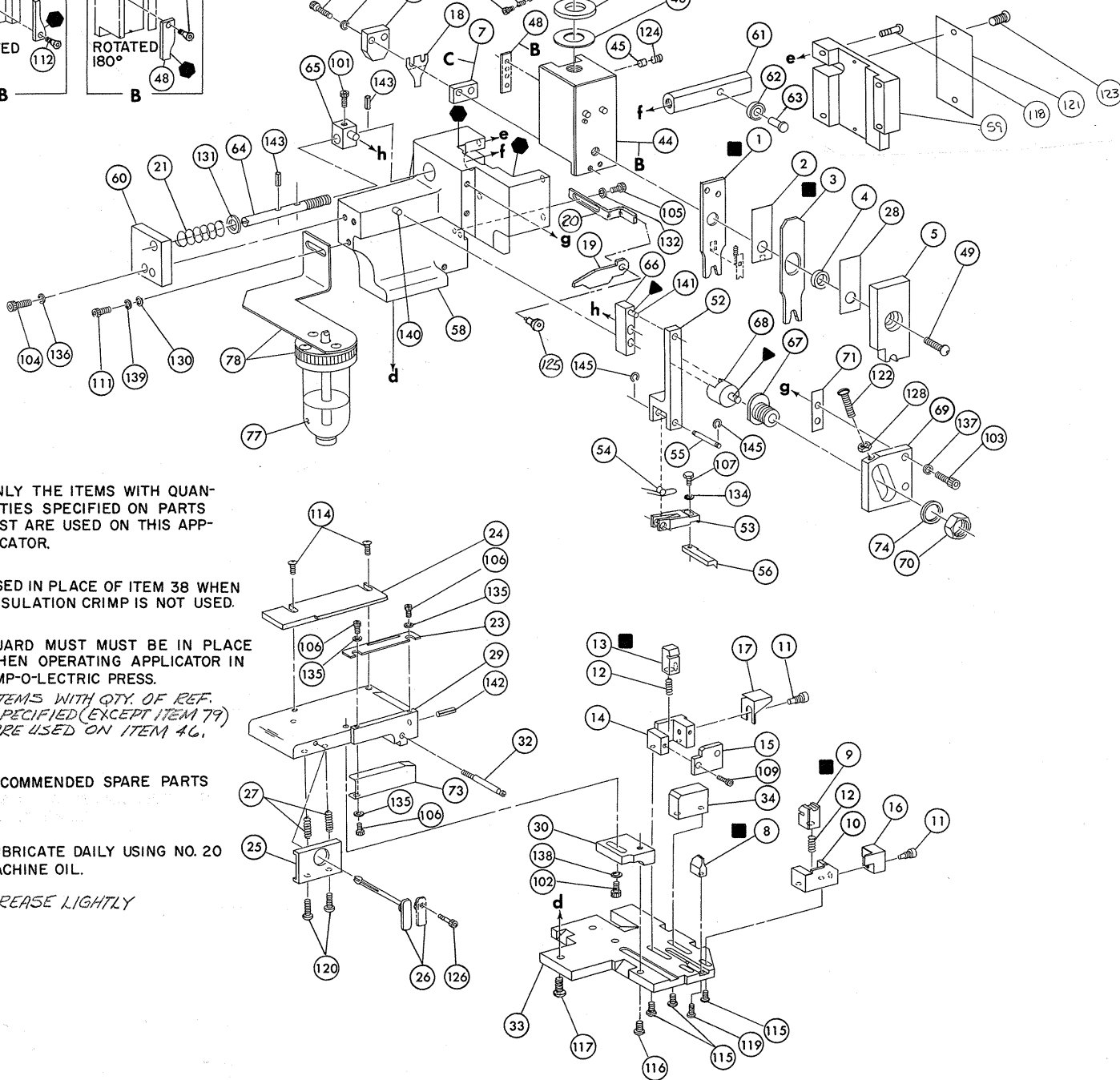
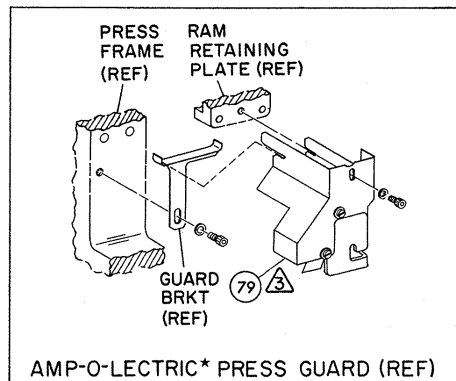
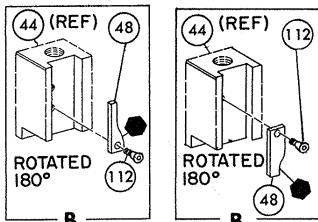

NOTES:

1- ONLY THE ITEMS WITH QUANTITIES SPECIFIED ON PARTS LIST ARE USED ON THIS APPLICATOR.

△- USED IN PLACE OF ITEM 38 WHEN INSULATION CRIMP IS NOT USED.

△- GUARD MUST BE IN PLACE WHEN OPERATING APPLICATOR IN AMP-O-LECTRIC PRESS.

4- ITEMS WITH QTY. OF REF. SPECIFIED (EXCEPT ITEM 79) ARE USED ON ITEM 46.

KEY:

■- RECOMMENDED SPARE PARTS

▲- LUBRICATE DAILY USING NO. 20 MACHINE OIL.

●- GREASE LIGHTLY

Parts list table with columns: REF., PART NO, DESCRIPTION, QTY, PART NO, DESCRIPTION, ITEM NO. Includes items like RING, RETAINING 'C', PIN, SLOT SPR, WASHER, LOCK, SCR, BUT HD SKT CAP, etc.

CRIMPING DATA and APPLICATOR WILL APPLY table. Includes columns: PAD LTR, CRIMP HEIGHT, WIRE SIZE, WIRE STRIP LENGTH, CRIMP SIZE, TYPE, FEED, APPL INST.

REMARKS, APPL USED ON MACHINE PART NO, CUSTOMER NAME, ADDRESS, CITY, MACH SERIAL NO, APPL SERIAL NO, PURCHASE ORDER, ENG APP, DISTRIBUTION, ORIGINAL, CUSTOMER COPY, FIELD ENG COPY.

Revision record table with columns: P/F/LTR, REVISION RECORD, APP DATE, P/F/LTR, REVISION RECORD, APP DATE, P/F/LTR, REVISION RECORD, APP DATE.

THIS IS A CONTROLLED DOCUMENT.

AMP 2983-3 (8-73) * Trademark of AMP Incorporated