

COMPLEMENTARY SILICON PLASTIC POWER TRANSISTORS

... designed for use in general purpose power amplifier and switching applications.

FEATURES:

* Collector-Emitter Sustaining Voltage -

$V_{CE(sus)}$ = 40V(Min)- TIP31, TIP32
 60V(Min)- TIP31A, TIP32A
 80V(Min)- TIP31B, TIP32B
 100V(Min)- TIP31C, TIP32C

* Collector-Emitter Saturation Voltage- $V_{CE(sat)} = 1.2V(Max) @ I_C = 3.0 A$

* Current Gain-Bandwidth Product $f_T = 3.0 MHz (Min) @ I_C = 500 mA$

NPN	PNP
TIP31	TIP32
TIP31A	TIP32A
TIP31B	TIP32B
TIP31C	TIP32C

3 AMPERE
 COMPLEMENTARY SILICON
 POWER TRANSISTORS
 40 -100 VOLTS
 40 WATTS

MAXIMUM RATINGS

Characteristic	Symbol	TIP31 TIP32	TIP31A TIP32A	TIP31B TIP32B	TIP31C TIP32C	Unit
Collector-Emitter Voltage	V_{CEO}	40	60	80	100	V
Collector-Base Voltage	V_{CBO}	40	60	80	100	V
Emitter-Base Voltage	V_{EBO}	5.0				V
Collector Current - Continuous - Peak	I_C	3.0 5.0				A
Base Current	I_B	1.0				A
Total Power Dissipation @ $T_C = 25^\circ C$ Derate above $25^\circ C$	P_D	40 0.32				W W/ $^\circ C$
Operating and Storage Junction Temperature Range	T_J, T_{STG}	-65 to +150				$^\circ C$

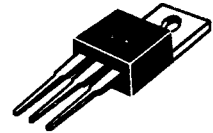

TO-220

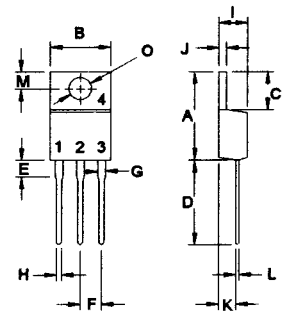

PIN 1. BASE
 2. COLLECTOR
 3. EMITTER
 4. COLLECTOR(CASE)

THERMAL CHARACTERISTICS

Characteristic	Symbol	Max	Unit
Thermal Resistance Junction to Case	$R_{\theta jc}$	3.125	$^\circ C/W$

DIM	MILLIMETERS	
	MIN	MAX
A	14.68	15.31
B	9.78	10.42
C	5.01	6.52
D	13.06	14.62
E	3.57	4.07
F	2.42	3.66
G	1.12	1.36
H	0.72	0.96
I	4.22	4.98
J	1.14	1.38
K	2.20	2.97
L	0.33	0.55
M	2.48	2.98
O	3.70	3.90

FIGURE -1 POWER DERATING

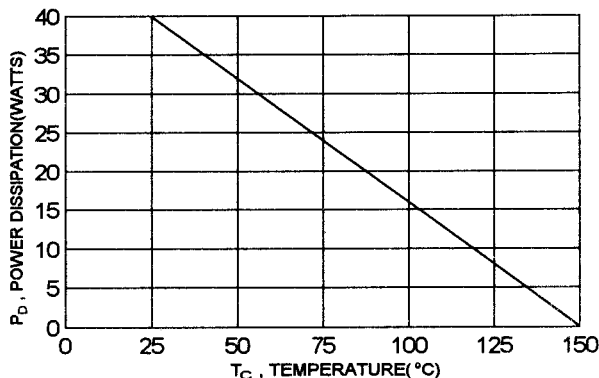

TIP31, TIP31A, TIP31B, TIP31C NPN / TIP32, TIP32A, TIP32B, TIP32C PNP

ELECTRICAL CHARACTERISTICS ($T_c = 25^\circ\text{C}$ unless otherwise noted)

Characteristic	Symbol	Min	Max	Unit
----------------	--------	-----	-----	------

OFF CHARACTERISTICS

Collector-Emitter Sustaining Voltage(1) ($I_C = 30\text{ mA}$, $I_B = 0$)	TIP31, TIP32 TIP31A, TIP32A TIP31B, TIP32B TIP31C, TIP32C	$V_{CE(sus)}$	40 60 80 100		V
Collector Cutoff Current ($V_{CE} = 30\text{ V}$, $I_B = 0$) ($V_{CE} = 60\text{ V}$, $I_B = 0$)	TIP31, TIP32, TIP31A, TIP32A TIP31B, TIP32B, TIP31C, TIP32C	I_{CEO}		0.3 0.3	mA
Collector Cutoff Current ($V_{CE} = 40\text{ V}$, $V_{EB} = 0$) ($V_{CE} = 60\text{ V}$, $V_{EB} = 0$) ($V_{CE} = 80\text{ V}$, $V_{EB} = 0$) ($V_{CE} = 100\text{ V}$, $V_{EB} = 0$)	TIP31, TIP32 TIP31A, TIP32A TIP31B, TIP32B TIP31C, TIP32C	I_{CES}		0.2 0.2 0.2 0.2	mA
Emitter Cutoff Current ($V_{EB} = 5.0\text{ V}$, $I_C = 0$)		I_{EBO}		1.0	mA

ON CHARACTERISTICS (1)

DC Current Gain ($I_C = 1.0\text{ A}$, $V_{CE} = 4.0\text{ V}$) ($I_C = 3.0\text{ A}$, $V_{CE} = 4.0\text{ V}$)	h_{FE}	25 10	50		
Collector-Emitter Saturation Voltage ($I_C = 3.0\text{ A}$, $I_B = 375\text{ mA}$)	$V_{CE(sat)}$		1.2		V
Base-Emitter On Voltage ($I_C = 3.0\text{ A}$, $V_{CE} = 4.0\text{ V}$)	$V_{BE(on)}$		1.8		V

DYNAMIC CHARACTERISTICS

Current Gain - Bandwidth Product (2) ($I_C = 500\text{ mA}$, $V_{CE} = 10\text{ V}$, $f_{TEST} = 1\text{ MHz}$)	f_T	3.0			MHz
Small Signal Current Gain ($I_C = 500\text{ mA}$, $V_{CE} = 10\text{ V}$, $f = 1\text{ kHz}$)	h_{fe}	20			

(1) Pulse Test: Pulse width $\leq 300\ \mu\text{s}$, Duty Cycle $\leq 2.0\%$

(2) $f_T = |h_{fe}| \cdot f_{TEST}$

FIGURE 2 - SWITCHING TIME EQUIVALENT CIRCUIT

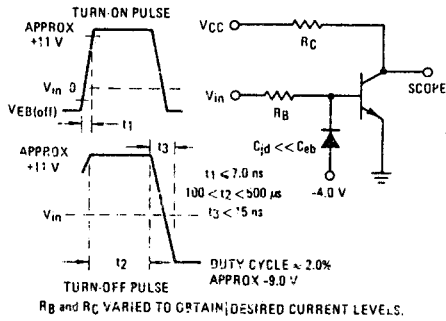

FIG-3 TURN-ON TIME

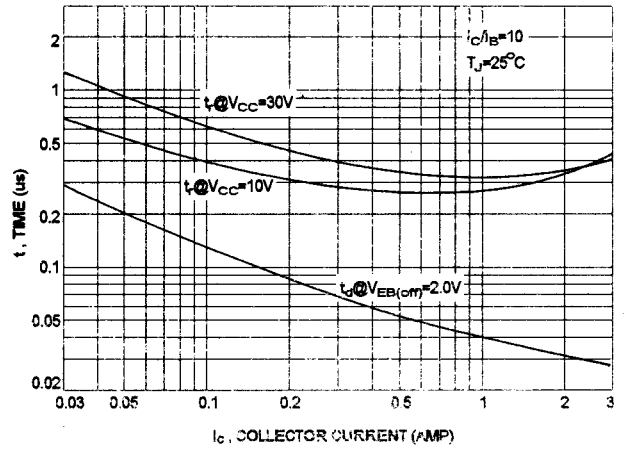

FIG-4 DC CURRENT GAIN

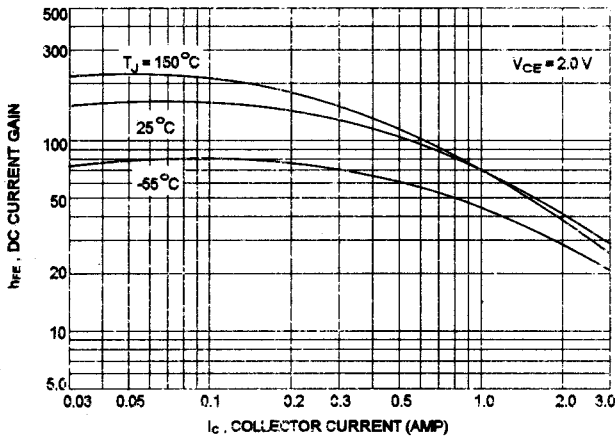

FIG-5 TURN-OFF TIME

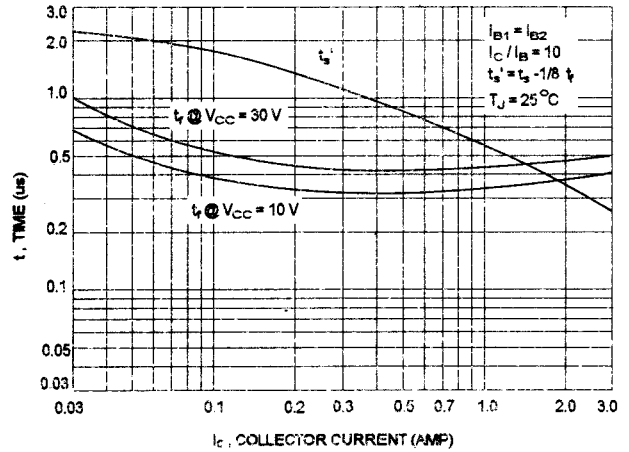
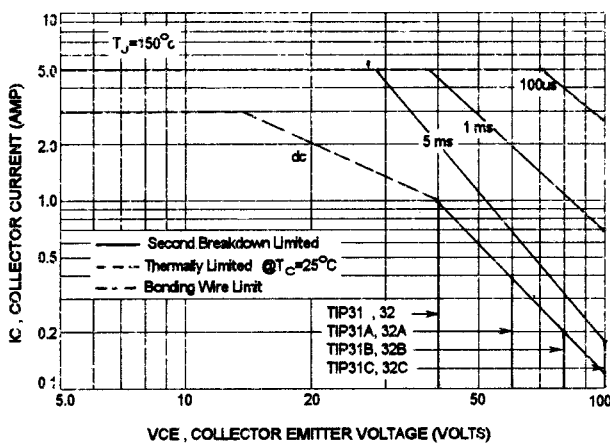

FIG-6 ACTIVE REGION SAFE OPERATING AREA



There are two limitation on the power handling ability of a transistor: average junction temperature and second breakdown safe operating area curves indicate I_C - V_{CE} limits of the transistor that must be observed for reliable operation i.e., the transistor must not be subjected to greater dissipation than curves indicate.

The data of FIG-6 curve is base on $T_{J(PK)} = 150^\circ C$; T_C is variable depending on power level. second breakdown pulse limits are valid for duty cycles to 10% provided $T_{J(PK)} \leq 150^\circ C$. At high case temperatures, thermal limitation will reduce the power that can be handled to values less than the limitations imposed by second breakdown.

TIP31, TIP31A, TIP31B, TIP31C NPN / TIP32, TIP32A, TIP32B, TIP32C PNP

FIG-7 COLLECTOR SATURATION REGION

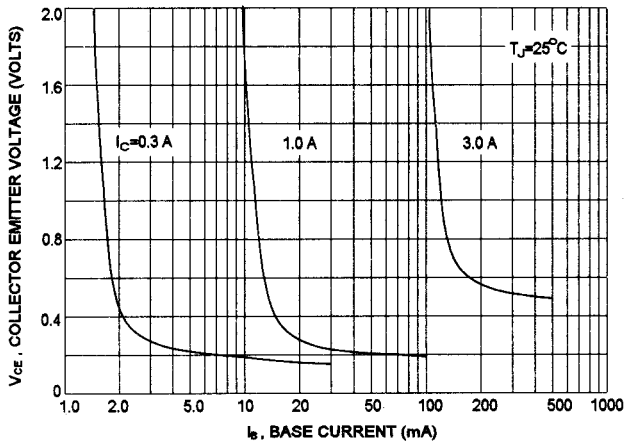

FIG-8 CAPACITANCES

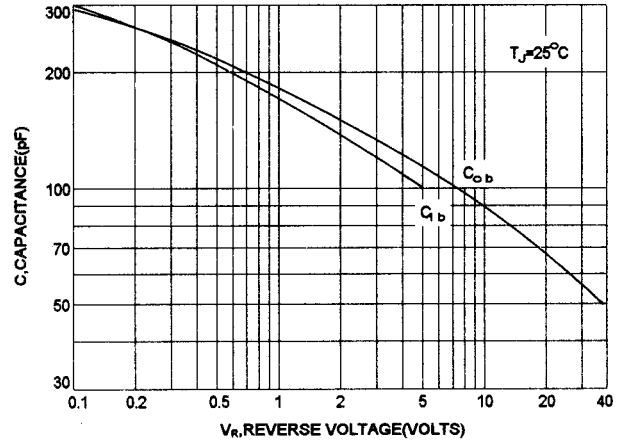

FIG-9 "ON" VOLTAGE

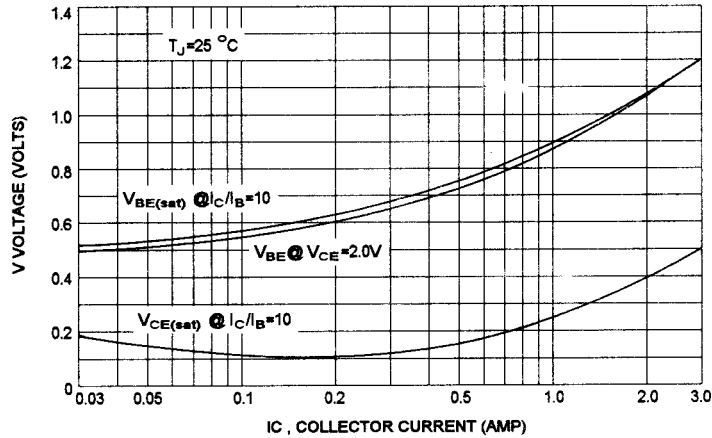

FIG-10 COLLECTOR CUT-OFF REGION

