



# OCTAL D-TYPE FLIP-FLOP WITH 3-STATE OUTPUTS

The MC74F574 is a high-speed, low-power octal D-type flip-flop featuring separate D-type inputs for each flip-flop and 3-state outputs for bus oriented applications. A buffered clock (CP) and Output Enable (OE) are common to all flip-flops.

This device is functionally identical to the F374 except for the pinouts.

- Broadside Pinout Version of F374
- Edge-Triggered D-Type Inputs
- Buffered Positive Edge-Triggered Clock
- 3-State Outputs for Bus Oriented Applications
- ESD Protection > 4000 Volts

## PIN ASSIGNMENT

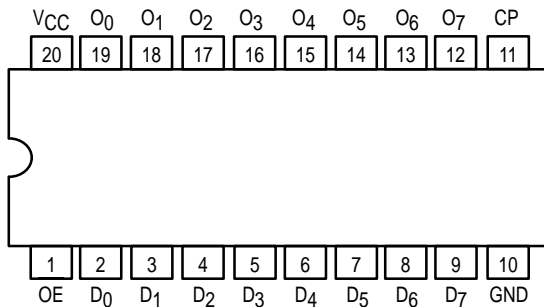

## LOGIC SYMBOL

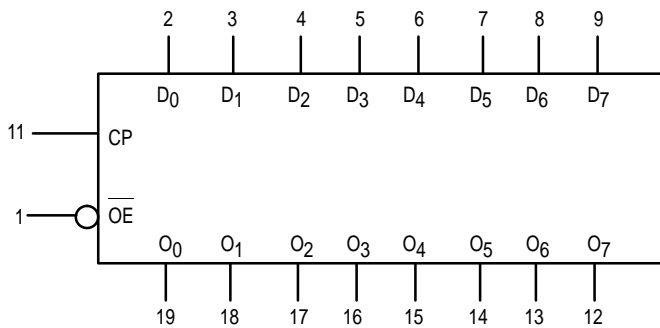

## MC74F574

### OCTAL D-TYPE FLIP-FLOP WITH 3-STATE OUTPUTS

FAST™ SCHOTTKY TTL

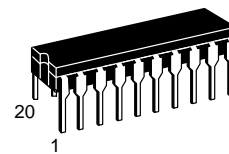

**J SUFFIX**  
CERAMIC  
CASE 732-03

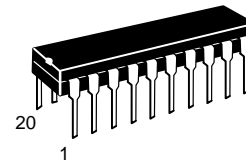

**N SUFFIX**  
PLASTIC  
CASE 738-03

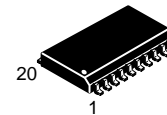

**DW SUFFIX**  
SOIC  
CASE 751D-03

### ORDERING INFORMATION

MC74FXXXJ Ceramic  
MC74FXXXN Plastic  
MC74FXXXDW SOIC

### GUARANTEED OPERATING RANGES

Symbol	Parameter	74	Min	Typ	Max	Unit
V <sub>CC</sub>	DC Supply Voltage	74	4.5	5.0	5.5	V
T <sub>A</sub>	Operating Ambient Temperature Range	74	0	25	70	°C
I <sub>OH</sub>	Output Current — High	74	—	—	3.0	mA
I <sub>OL</sub>	Output Current — Low	74	—	—	24	mA

LIFETIME BUY

LAST SHIP 30/09/99  
LAST ORDER 31/03/99

# MC74F574

**FUNCTION TABLE**

Inputs			Internal Register	Outputs	Operating Mode
OE	CP	D <sub>n</sub>		Q <sub>0</sub> –Q <sub>7</sub>	
L L	↑ ↑	l h	L H	L H	Load and read register
L	‡	X	NC	NC	Hold
H H	↑ X	D <sub>n</sub> X	D <sub>n</sub> X	Z Z	Disable outputs

H = HIGH voltage level  
h = HIGH voltage level one set-up time prior to the Low-to-High clock transition  
L = LOW voltage level  
l = LOW voltage level one set-up time prior to the Low-to-High clock transition  
NC = No change  
X = Don't care  
Z = High impedance "off" state  
↑ = Low-to-High clock transition  
‡ = Not a Low-to-High clock transition

## FUNCTIONAL DESCRIPTION

The MC74F574 consists of eight edge-triggered flip-flops with individual D-type inputs and 3-state true outputs. The buffered clock and buffered Output Enable are common to all flip-flops. The eight flip-flops will store the state of their individual D inputs that meet the setup and hold times requirements

on the LOW-to-HIGH Clock (CP) transition. With the Output Enable (OE) LOW, the contents of the eight flip-flops are available at the outputs. When the OE is HIGH, the outputs go to the high impedance state. Operation of the OE input does not affect the state of the flip-flops.

## DC CHARACTERISTICS OVER OPERATING TEMPERATURE RANGE (unless otherwise specified)

Symbol	Parameter	Limits			Unit	Test Conditions (Note 1)	
		Min	Typ	Max			
V <sub>IH</sub>	Input HIGH Voltage	2.0	—	—	V	Guaranteed Input HIGH Voltage	
V <sub>IL</sub>	Input LOW Voltage	—	—	0.8	V	Guaranteed Input LOW Voltage	
V <sub>IK</sub>	Input Clamp Diode Voltage	—	—	–1.2	V	V <sub>CC</sub> = MIN, I <sub>IN</sub> = –18 mA	
V <sub>OH</sub>	Output HIGH Voltage	2.4	—	—	V	I <sub>OH</sub> = –3.0 mA	V <sub>CC</sub> = MIN
		2.7	—	—	V		V <sub>CC</sub> = 4.75 V
V <sub>OL</sub>	Output LOW Voltage	—	—	0.5	V	I <sub>OL</sub> = 24 mA	V <sub>CC</sub> = MIN
I <sub>IH</sub>	Input HIGH Current	—	—	20	μA	V <sub>CC</sub> = MAX, V <sub>IN</sub> = 2.7 V	
		—	—	100		V <sub>CC</sub> = MAX, V <sub>IN</sub> = 7.0 V	
I <sub>IL</sub>	Input LOW Current	—	—	–0.6	mA	V <sub>CC</sub> = MAX, V <sub>IN</sub> = 0.5 V	
I <sub>OZH</sub>	Output Off Current — HIGH	—	—	50	μA	V <sub>CC</sub> = MAX, V <sub>OUT</sub> = 2.7 V	
I <sub>OZL</sub>	Output Off Current — LOW	—	—	–50	μA	V <sub>CC</sub> = MAX, V <sub>OUT</sub> = 0.5 V	
I <sub>OS</sub>	Output Short Circuit Current (Note 2)	–60	—	–150	mA	V <sub>CC</sub> = MAX, V <sub>OUT</sub> = 0 V	
I <sub>CCZ</sub>	Power Supply Current (All Outputs OFF)	—	55	86	mA	V <sub>CC</sub> = MAX	D <sub>n</sub> – GND; OE = 4.5 V

**NOTES:**

- For conditions shown as MIN or MAX, use the appropriate value specified under recommended operating conditions for the applicable device type.
- Not more than one output should be shorted at a time, nor for more than 1 second.

LIFETIME BUY

LAST SHIP 30/09/99  
LAST ORDER 31/03/99

# MC74F574

## LOGIC DIAGRAM

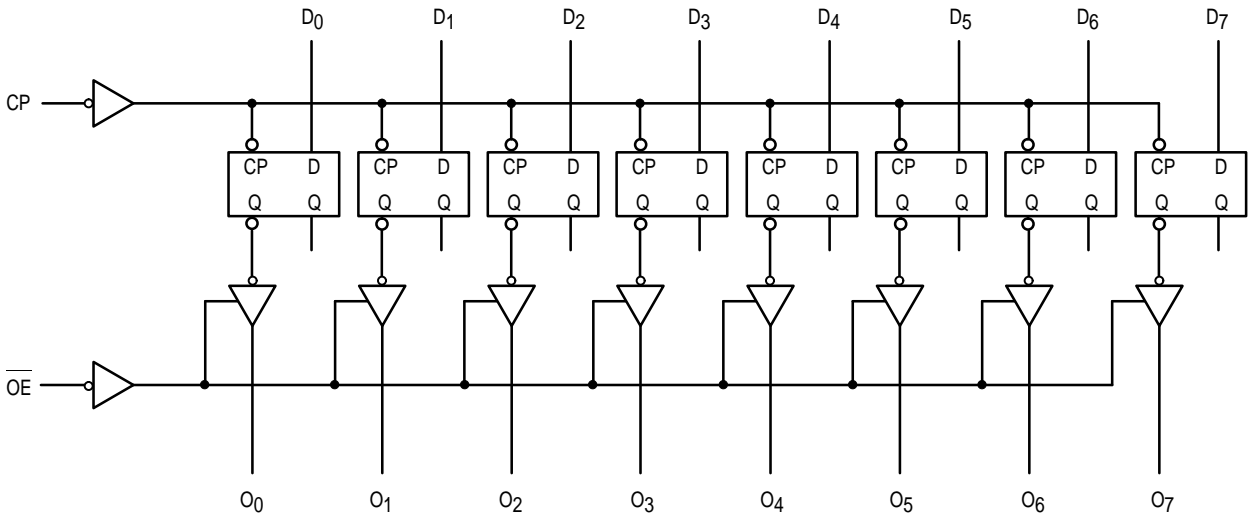

## AC ELECTRICAL CHARACTERISTICS

Symbol	Parameter	54/74F			74F		Unit
		$T_A = +25^\circ\text{C}$ $V_{CC} = +5.0\text{ V}$ $C_L = 50\text{ pF}$			$T_A = 0^\circ\text{C to } +70^\circ\text{C}$ $V_{CC} = +5.0\text{ V } \pm 10\%$ $C_L = 50\text{ pF}$		
		Min	Typ	Max	Min	Max	
$f_{MAX}$	Maximum Clock Frequency	100	—	—	70	—	MHz
$t_{PLH}$ $t_{PHL}$	Propagation Delay CP to $O_n$	2.5	—	8.5	2.5	8.5	ns
$t_{PZH}$ $t_{PZL}$	Output Enable Time	3.0	—	9.0	2.5	10.0	ns
$t_{PHZ}$ $t_{PLZ}$	Output Disable Time	1.5	—	5.5	1.5	6.5	ns

## AC OPERATING CHARACTERISTICS

Symbol	Parameter	54/74F			74F			Unit
		$T_A = +25^\circ\text{C}$ $V_{CC} = +5.0\text{ V}$ $C_L = 50\text{ pF}$			$T_A = 0^\circ\text{C to } +70^\circ\text{C}$ $V_{CC} = +5.0\text{ V } \pm 10\%$ $C_L = 50\text{ pF}$			
		Min	Typ	Max	Min	Typ	Max	
$t_{s(H)}$ $t_{s(L)}$	Setup Time, HIGH or LOW $D_n$ to CP	2.5	—	—	2.5	—	—	ns
$t_{h(H)}$ $t_{h(L)}$	Hold Time, HIGH to LOW $D_n$ to CP	2.0	—	—	2.0	—	—	ns
$t_{w(H)}$ $t_{w(L)}$	CP Pulse Width HIGH or LOW	5.0	—	—	5.0	—	—	ns

LIFETIME BUY

LAST SHIP 30/09/99  
LAST ORDER 31/03/99

LIFETIME BUY

LAST ORDER 31/03/99 LAST SHIP 30/09/99

Mfax is a trademark of Motorola, Inc.

Motorola reserves the right to make changes without further notice to any products herein. Motorola makes no warranty, representation or guarantee regarding the suitability of its products for any particular purpose, nor does Motorola assume any liability arising out of the application or use of any product or circuit, and specifically disclaims any and all liability, including without limitation consequential or incidental damages. "Typical" parameters which may be provided in Motorola data sheets and/or specifications can and do vary in different applications and actual performance may vary over time. All operating parameters, including "Typicals" must be validated for each customer application by customer's technical experts. Motorola does not convey any license under its patent rights nor the rights of others. Motorola products are not designed, intended, or authorized for use as components in systems intended for surgical implant into the body, or other applications intended to support or sustain life, or for any other application in which the failure of the Motorola product could create a situation where personal injury or death may occur. Should Buyer purchase or use Motorola products for any such unintended or unauthorized application, Buyer shall indemnify and hold Motorola and its officers, employees, subsidiaries, affiliates, and distributors harmless against all claims, costs, damages, and expenses, and reasonable attorney fees arising out of, directly or indirectly, any claim of personal injury or death associated with such unintended or unauthorized use, even if such claim alleges that Motorola was negligent regarding the design or manufacture of the part. Motorola and  are registered trademarks of Motorola, Inc. Motorola, Inc. is an Equal Opportunity/Affirmative Action Employer.

**How to reach us:**

**USA/EUROPE/Locations Not Listed:** Motorola Literature Distribution; P.O. Box 5405, Denver, Colorado 80217.  
1-303-675-2140 or 1-800-441-2447

**JAPAN:** Motorola Japan Ltd.; SPS, Technical Information Center, 3-20-1, Minami-Azabu. Minato-ku, Tokyo 106-8573 Japan.  
81-3-3440-3569

**ASIA/PACIFIC:** Motorola Semiconductors H.K. Ltd.; Silicon Harbour Centre, 2 Dai King Street, Tai Po Industrial Estate, Tai Po, N.T., Hong Kong. 852-26668334

**Customer Focus Center: 1-800-521-6274**

**Mfax™:** RMFAX0@email.sps.mot.com – TOUCHTONE 1-602-244-6609  
Motorola Fax Back System – US & Canada ONLY 1-800-774-1848  
– <http://sps.motorola.com/mfax/>

**HOME PAGE:** <http://motorola.com/sps/>



**MOTOROLA**

