

- RF SAW Filter, 2332.5 MHz, 25.6 MHz Bandwidth
- 3.0 x 3.0 x 1.4 mm Surface-mount Case
- Input/Output Impedance 50Ω/50Ω
- AEC-Q200 Qualified
- Moisture Sensitivity Level: 1
- Complies with Directive 2002/95/EC (RoHS)

SF1224E-1

**2332.5 MHz
SAW Filter**

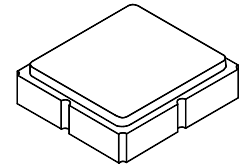

SM3030-6

Absolute Maximum Ratings

Rating	Value	Units
Incident Power in Passband	+15	dBm
Incident Power Out of Band	+27	dBm
DC Voltage on any Non-ground Terminal	3	VDC
Operating Temperature Range	-40 to +105	°C
Component Storage Temperature Range	-40 to +105	°C
Storage Temperature Range in Tape and Reel	-40 to +85	°C
Maximum Soldering Profile, 5 cycles/10 seconds maximum	265	°C

Electrical Characteristics

Characteristic	Sym	Notes	Min	Typ	Max	Units
Center Frequency	f_c			2332.5		MHz
Maximum Insertion Loss, 2319.4 to 2345.0 MHz	IL			1.5	2.5	dB
Amplitude Ripple, p-p, 2319.4 to 2345.0 MHz				0.7	1.2	
I/O Return Loss, 2319.4 to 2345.0 MHz			10	12		
I/O VSWR, 2319.4 to 2345.0 MHz				1.7:1	2.2:1	
Attenuation (Reference level from 0 dB)						dB
10 to 2224 MHz			30	38		
2453 to 2600 MHz			35	42		
2600 to 3000 MHz			30	35		
3000 to 6000 MHz			15	18		
Terminating Source impedance	Z_s			50		Ω
Terminating Load impedance	Z_L			50		Ω

Single Ended Input / Output, Impedance match	No matching network required for operation at 50 ohms
Case Style	SM3030-6
Lid Symbolization: Y = Year, WW = Week, S = Shift)	A65, <u>YWW</u> S

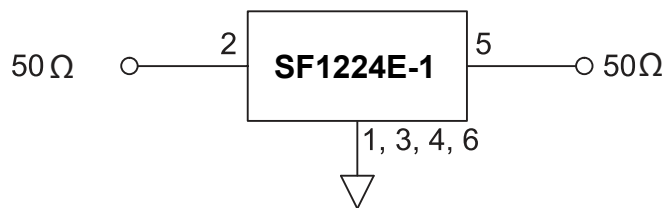

 **CAUTION: Electrostatic Sensitive Device. Observe precautions for handling.**
NOTES:

1. The design, manufacturing process, and specifications of this device are subject to change.
2. US or International patents may apply.
3. RoHS compliant from the first date of manufacture.

Filter Response Plots

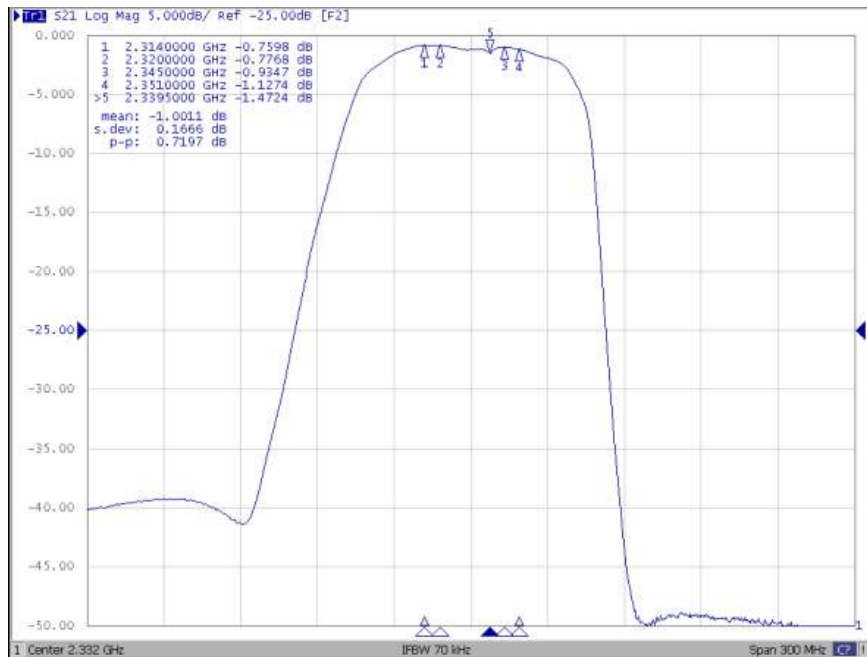
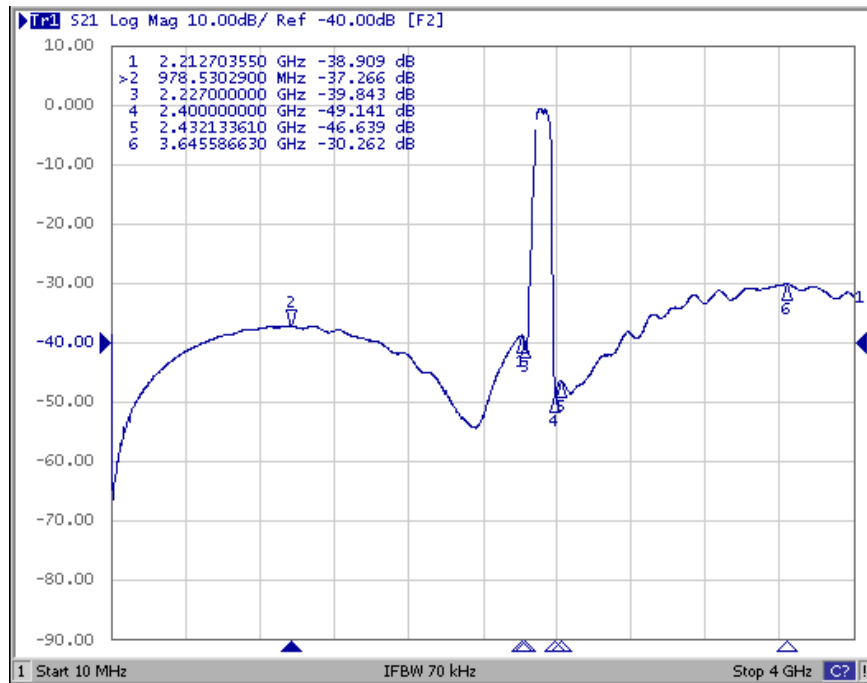

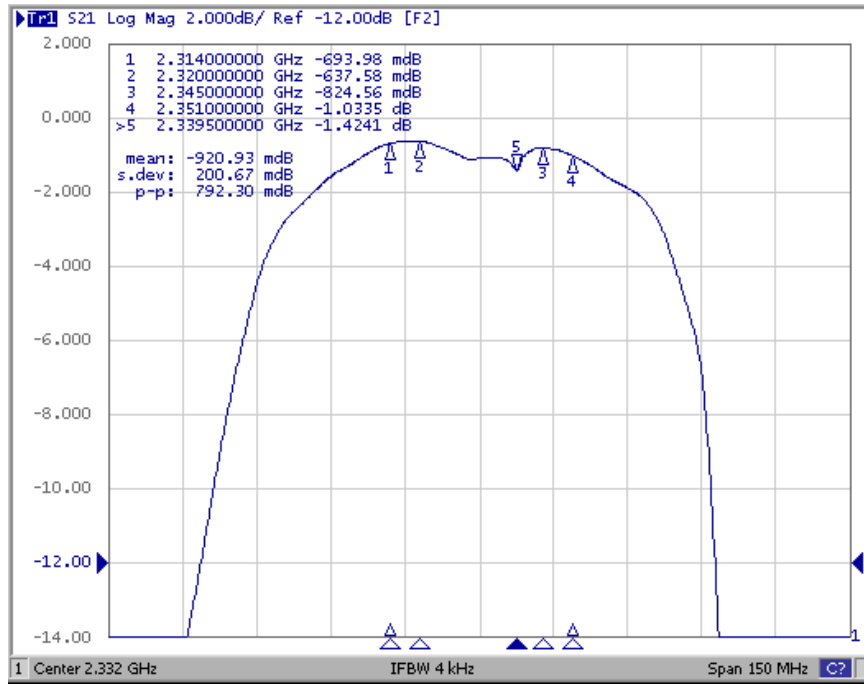

Input/Output VSWR Plots

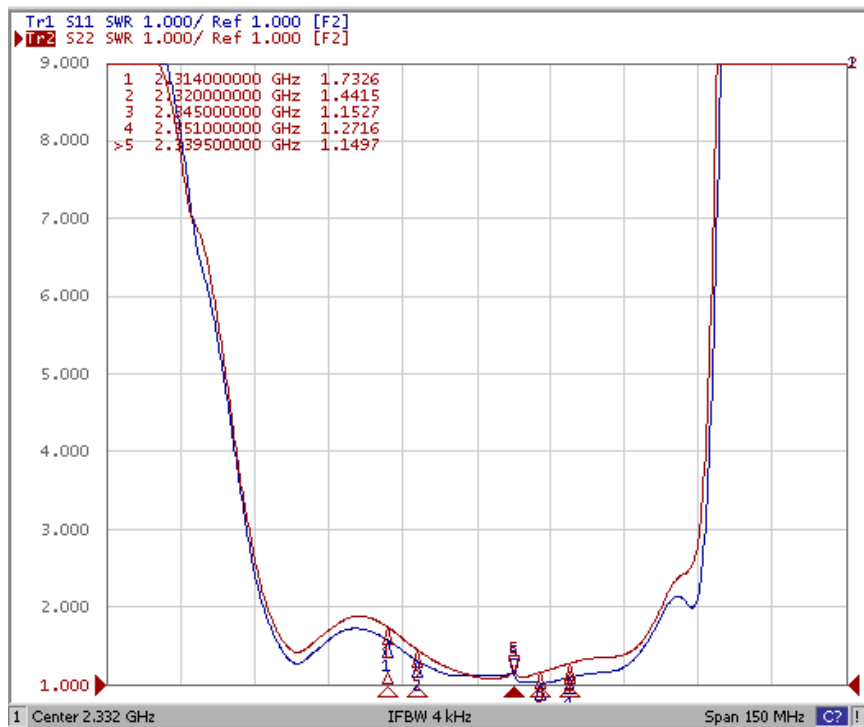

6-Terminal Ceramic Surface-Mount Case 3.0 X 3.0 mm Nominal Footprint

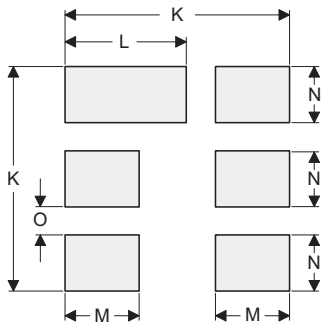
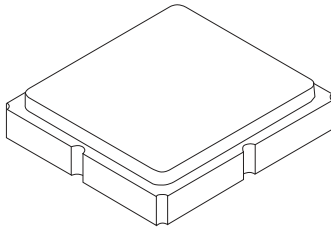

PCB Footprint Top View

Case and PCB Footprint Dimensions

Dimension	mm			Inches		
	Min	Nom	Max	Min	Nom	Max
A	2.87	3.00	3.13	0.113	0.118	0.123
B	2.87	3.00	3.13	0.113	0.118	0.123
C	1.12	1.25	1.38	0.044	0.049	0.054
D	0.77	0.90	1.03	0.030	0.035	0.040
E	2.67	2.80	2.93	0.105	0.110	0.115
F	1.47	1.60	1.73	0.058	0.063	0.068
G	0.72	0.85	0.98	0.028	0.033	0.038
H	1.37	1.50	1.63	0.054	0.059	0.064
I	0.47	0.60	0.73	0.019	0.024	0.029
J	1.17	1.30	1.43	0.046	0.051	0.056
K		3.20			0.126	
L		1.70			0.067	
M		1.05			0.041	
N		0.81			0.032	
O		0.38			0.015	

Case Materials

Materials	
Solder Pad Plating	0.3 to 1.0 μm Gold over 1.27 to 8.89 μm Nickel
Lid Plating	2.0 to 3.0 μm Nickel
Body	Al_2O_3 Ceramic

TOP VIEW

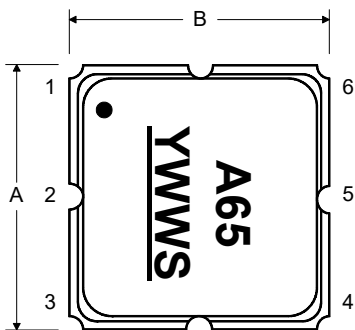

BOTTOM VIEW

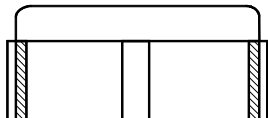
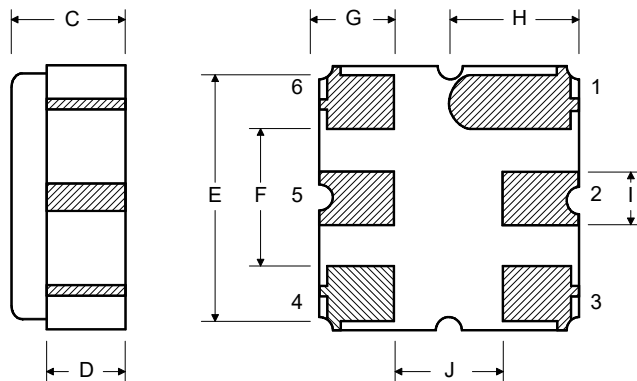

Tape and Reel Specifications

Tape and Reel Standard per ANSI/EIA-481

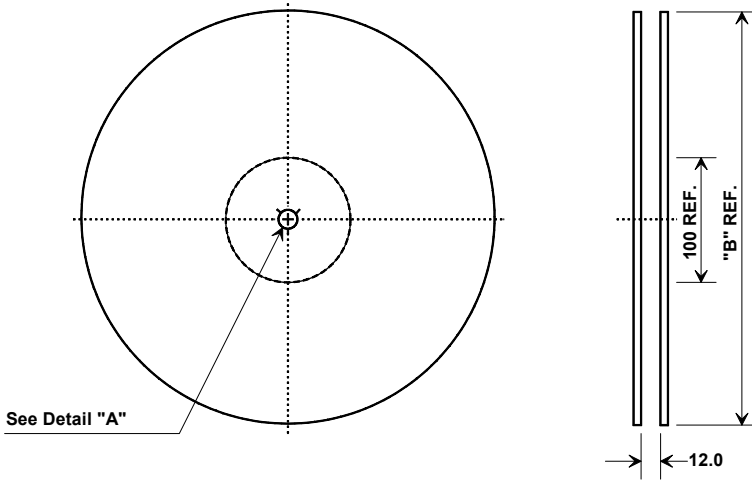

"B"		Quantity Per Reel
Inches	millimeters	
7	178	500
13	330	3000

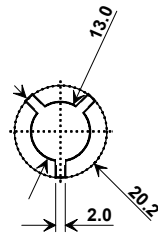

COMPONENT ORIENTATION and DIMENSIONS

Carrier Tape Dimensions	
Ao	3.35 mm
Bo	3.35 mm
Ko	1.40 mm
Pitch	8.0 mm
W	12.0 mm

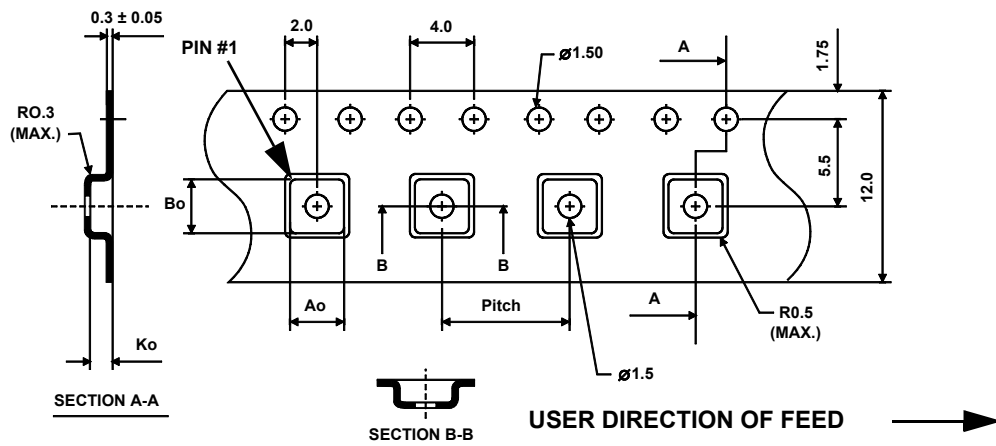

Recommended Reflow Profile

1. Preheating shall be fixed at 150~180°C for 60~90 seconds.
2. Ascending time to preheating temperature 150°C shall be 30 seconds min.
3. Heating shall be fixed at 220°C for 50~80 seconds and at 260°C+0/-5°C peak (10 seconds).
4. Time: 5 times maximum.

