

National Semiconductor is now part of
Texas Instruments.

Search <http://www.ti.com/> for the latest technical
information and details on our current products and services.

LMV221

50 MHz to 3.5 GHz 40 dB Logarithmic Power Detector for CDMA and WCDMA

General Description

The LMV221 is a 40 dB RF power detector intended for use in CDMA and WCDMA applications. The device has an RF frequency range from 50 MHz to 3.5 GHz. It provides an accurate temperature and supply compensated output voltage that relates linearly to the RF input power in dBm. The circuit operates with a single supply from 2.7V to 3.3V.

The LMV221 has an RF power detection range from -45 dBm to -5 dBm and is ideally suited for direct use in combination with a 30 dB directional coupler. Additional low-pass filtering of the output signal can be realized by means of an external resistor and capacitor. Figure (a) shows a detector with an additional output low pass filter. The filter frequency is set with R_S and C_S .

Figure (b) shows a detector with an additional feedback low pass filter. Resistor R_P is optional and will lower the Trans impedance gain (R_{TRANS}). The filter frequency is set with C_P/C_{TRANS} and R_P/R_{TRANS} .

The device is active for Enable = High, otherwise it is in a low power consumption shutdown mode. To save power and prevent discharge of an external filter capacitance, the output (OUT) is high-impedance during shutdown.

The LMV221 power detector is offered in the small 2.2 mm x 2.5 mm x 0.8 mm LLP package.

Features

- 40 dB linear in dB power detection range
- Output voltage range 0.3 to 2V
- Shutdown
- Multi-band operation from 50 MHz to 3.5 GHz
- 0.5 dB accurate temperature compensation
- External configurable output filter bandwidth
- 2.2 mm x 2.5 mm x 0.8 mm LLP 6 package

Applications

- UMTS/CDMA/WCDMA RF power control
- GSM/GPRS RF power control
- PA modules
- IEEE 802.11b, g (WLAN)

Typical Application

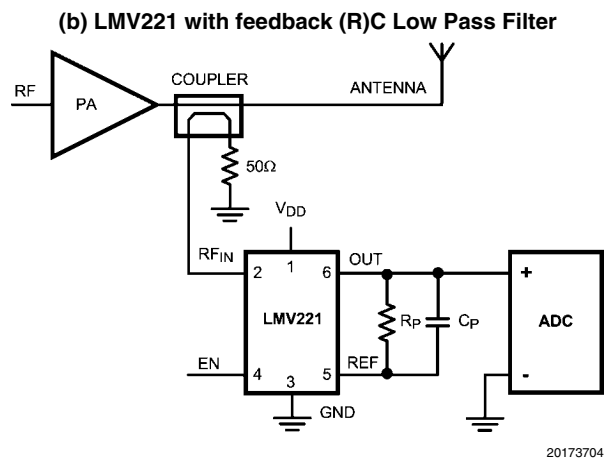
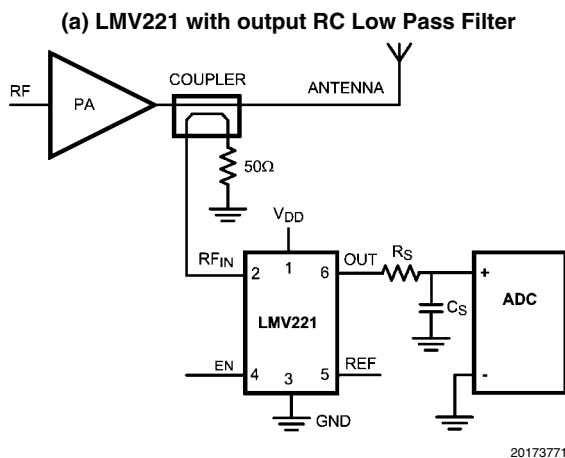

Absolute Maximum Ratings (Note 1)

If Military/Aerospace specified devices are required, please contact the National Semiconductor Sales Office/ Distributors for availability and specifications.

Supply Voltage		
$V_{DD} - GND$	3.6V	
RF Input		
Input power	10 dBm	
DC Voltage	400 mV	
Enable Input Voltage	$V_{SS} - 0.4V < V_{EN} < V_{DD} + 0.4V$	
ESD Tolerance (Note 2)		
Human Body Model	2000V	
Machine Model	200V	
Charge Device Model	2000V	
Storage Temperature Range	-65°C to 150°C	

Junction Temperature (Note 3)	150°C
Maximum Lead Temperature (Soldering, 10 sec)	260°C

Operating Ratings (Note 1)

Supply Voltage	2.7V to 3.3V
Temperature Range	-40°C to +85°C
RF Frequency Range	50 MHz to 3.5 GHz
RF Input Power Range (Note 5)	-45 dBm to -5 dBm -58 dBV to -18 dBV
Package Thermal Resistance θ_{JA} (Note 3)	86.6°C/W

2.7 V DC and AC Electrical Characteristics

Unless otherwise specified, all limits are guaranteed to; $T_A = 25^\circ\text{C}$, $V_{DD} = 2.7\text{V}$, RF input frequency $f = 1855\text{ MHz CW}$ (Continuous Wave, unmodulated). **Boldface** limits apply at the temperature extremes (Note 4).

Symbol	Parameter	Condition	Min (Note 6)	Typ (Note 7)	Max (Note 6)	Units
Supply Interface						
I_{DD}	Supply Current	Active mode: EN = High, no Signal present at RF_{IN} .	6.5 5	7.2	8.5 10	mA
		Shutdown: EN = Low, no Signal present at RF_{IN} .		0.5	3 4	
		EN = Low: $P_{IN} = 0\text{ dBm}$ (Note 8)			10	
Logic Enable Interface						
V_{LOW}	EN Logic Low Input Level (Shutdown mode)				0.6	V
V_{HIGH}	EN Logic High Input Level		1.1			V
I_{EN}	Current into EN Pin				1	μA
RF Input Interface						
R_{IN}	Input Resistance		40	47.1	60	Ω
Output Interface						
V_{OUT}	Output Voltage Swing	From Positive Rail, Sourcing, $V_{REF} = 0\text{V}$, $I_{OUT} = 1\text{ mA}$		16	40 50	mV
		From Negative Rail, Sinking, $V_{REF} = 2.7\text{V}$, $I_{OUT} = 1\text{ mA}$		14	40 50	
I_{OUT}	Output Short Circuit Current	Sourcing, $V_{REF} = 0\text{V}$, $V_{OUT} = 2.6\text{V}$	3 2.7	5.4		mA
		Sinking, $V_{REF} = 2.7\text{V}$, $V_{OUT} = 0.1\text{V}$	3 2.7	5.7		
BW	Small Signal Bandwidth	No RF input signal. Measured from REF input current to V_{OUT}		450		kHz
R_{TRANS}	Output Amp Transimpedance Gain	No RF Input Signal, from I_{REF} to V_{OUT} , DC	35	42.7	55	$\text{k}\Omega$
SR	Slew Rate	Positive, V_{REF} from 2.7V to 0V	3 2.7	4.1		$\text{V}/\mu\text{s}$
		Negative, V_{REF} from 0V to 2.7V	3 2.7	4.2		
R_{OUT}	Output Impedance (Note 8)	No RF Input Signal, EN = High. DC measurement		0.6	5 6	Ω

Symbol	Parameter	Condition	Min (Note 6)	Typ (Note 7)	Max (Note 6)	Units
$I_{OUT,SD}$	Output Leakage Current in Shutdown mode	EN = Low, $V_{OUT} = 2.0V$		21	300 500	nA
RF Detector Transfer						
$V_{OUT,MAX}$	Maximum Output Voltage $P_{IN} = -5$ dBm (Note 8)	f = 50 MHz	1.67	1.76	1.83	V
		f = 900 MHz	1.67	1.75	1.82	
		f = 1855 MHz	1.53	1.61	1.68	
		f = 2500 MHz	1.42	1.49	1.57	
		f = 3000 MHz	1.33	1.40	1.48	
		f = 3500 MHz	1.21	1.28	1.36	
$V_{OUT,MIN}$	Minimum Output Voltage (Pedestal)	No input Signal	175 142	250	350 388	mV
$\Delta V_{OUT,MIN}$	Pedestal Variation over temperature	No Input Signal, Relative to 25°C	-20		20	mV
ΔV_{OUT}	Output Voltage Range P_{IN} from -45 dBm to -5 dBm (Note 8)	f = 50 MHz	1.37	1.44	1.52	V
		f = 900 MHz	1.34	1.40	1.47	
		f = 1855 MHz	1.24	1.30	1.37	
		f = 2500 MHz	1.14	1.20	1.30	
		f = 3000 MHz	1.07	1.12	1.20	
		f = 3500 MHz	0.96	1.01	1.09	
K_{SLOPE}	Logarithmic Slope (Note 8)	f = 50 MHz	39	40.5	42	mV/dB
		f = 900 MHz	36.7	38.5	40	
		f = 1855 MHz	34.4	35.7	37.1	
		f = 2500 MHz	32.6	33.8	35.2	
		f = 3000 MHz	31	32.5	34	
		f = 3500 MHz	30	31.9	33.5	
P_{INT}	Logarithmic Intercept (Note 8)	f = 50 MHz	-50.4	-49.4	-48.3	dBm
		f = 900 MHz	-54.1	-52.8	-51.6	
		f = 1855 MHz	-53.2	-51.7	-50.2	
		f = 2500 MHz	-51.8	-50	-48.3	
		f = 3000 MHz	-51.1	-48.9	-46.6	
		f = 3500 MHz	-49.6	-46.8	-44.1	
t_{ON}	Turn-on Time (Note 8)	No signal at P_{IN} , Low-High transition EN. V_{OUT} to 90%		8	10 12	μs
t_R	Rise Time (Note 9)	$P_{IN} =$ No signal to 0 dBm, V_{OUT} from 10% to 90%		2	12	μs
t_F	Fall Time (Note 9)	$P_{IN} =$ 0 dBm to no signal, V_{OUT} from 90% to 10%		2	12	μs
e_n	Output Referred Noise (Note 9)	$P_{IN} = -10$ dBm, at 10 kHz		1.5		$\mu V/\sqrt{Hz}$
v_N	Output referred Noise (Note 8)	Integrated over frequency band 1 kHz - 6.5 kHz		100	150	μV_{RMS}
PSRR	Power Supply Rejection Ratio (Note 9)	$P_{IN} = -10$ dBm, f = 1800 MHz	55	60		dB

Symbol	Parameter	Condition	Min (Note 6)	Typ (Note 7)	Max (Note 6)	Units
Power Measurement Performance						
E _{LC}	Log Conformance Error (Note 8) -40 dBm ≤ P _{IN} ≤ -10 dBm	f = 50 MHz	-0.60 -1.10	0.53	0.56 1.3	dB
		f = 900 MHz	-0.70 -1.24	0.46	0.37 1.1	
		f = 1855 MHz	-0.40 -1.1	0.48	0.24 1.1	
		f = 2500 MHz	-0.43 -1.0	0.51	0.56 1.1	
		f = 3000 MHz	-0.87 -1.2	0.56	1.34 1.6	
		f = 3500 MHz	-1.73 -2.0	0.84	2.72 2.7	
E _{VOT}	Variation over Temperature (Note 8) -40 dBm ≤ P _{IN} ≤ -10 dBm	f = 50 MHz	-1.1	0.4	1.4	dB
		f = 900 MHz	-1.0	0.38	1.27	
		f = 1855 MHz	-1.1	0.44	1.31	
		f = 2500 MHz	-1.1	0.48	1.15	
		f = 3000 MHz	-1.2	0.5	0.98	
		f = 3500 MHz	-1.2	0.62	0.85	
E _{1 dB}	Measurement Error for a 1 dB input power step (Note 8) -40 dBm ≤ P _{IN} ≤ -10 dBm	f = 50 MHz	-0.06		0.069	dB
		f = 900 MHz	-0.056		0.056	
		f = 1855 MHz	-0.069		0.069	
		f = 2500 MHz	-0.084		0.084	
		f = 3000 MHz	-0.092		0.092	
		f = 3500 MHz	-0.10		0.10	
E _{10 dB}	Measurement Error for a 10 dB input power step (Note 8) -40 dBm ≤ P _{IN} ≤ -10 dBm	f = 50 MHz	-0.65		0.57	dB
		f = 900 MHz	-0.75		0.58	
		f = 1855 MHz	-0.88		0.72	
		f = 2500 MHz	-0.86		0.75	
		f = 3000 MHz	-0.85		0.77	
		f = 3500 MHz	-0.76		0.74	
S _T	Temperature Sensitivity -40°C < T _A < 25°C (Note 8) -40 dBm ≤ P _{IN} ≤ -10 dBm	f = 50 MHz	-15	-7	1	mdB/°C
		f = 900 MHz	-13.4	-6	1.5	
		f = 1855 MHz	-14.1	-5.9	2.3	
		f = 2500 MHz	-13.4	-4.1	5.2	
		f = 3000 MHz	-11.7	-1.8	8	
		f = 3500 MHz	-10.5	0.5	1.2	
S _T	Temperature Sensitivity 25°C < T _A < 85°C (Note 8) -40 dBm ≤ P _{IN} ≤ -10 dBm	f = 50 MHz	-12.3	-6.7	-1.1	mdB/°C
		f = 900 MHz	-13.1	-6.7	-0.2	
		f = 1855 MHz	-14.7	-7.1	0.42	
		f = 2500 MHz	-15.9	-7.6	0.63	
		f = 3000 MHz	-18	-8.5	1	
		f = 3500 MHz	-21.2	-9.5	2.5	
S _T	Temperature Sensitivity -40°C < T _A < 25°C, (Note 8) P _{IN} = -10 dBm	f = 50 MHz	-15.8	-8.3	-0.75	mdB/°C
		f = 900 MHz	-14.2	-6	2.2	
		f = 1855 MHz	-14.9	-7.4	2	
		f = 2500 MHz	-14.5	-6.6	1.3	
		f = 3000 MHz	-13	-4.9	3.3	
		f = 3500 MHz	-12	-3.4	5.3	

Symbol	Parameter	Condition	Min (Note 6)	Typ (Note 7)	Max (Note 6)	Units
S _T	Temperature Sensitivity 25°C < T _A < 85°C, (Note 8) P _{IN} = -10 dBm	f = 50 MHz	-12.4	-8.9	-5.3	mdB/°C
		f = 900 MHz	-13.7	-9.4	-5	
		f = 1855 MHz	-14.6	-10	-5.6	
		f = 2500 MHz	-15.2	-10.8	-6.5	
		f = 3000 MHz	-16.5	-12.2	-7.9	
		f = 3500 MHz	-18.1	-13.5	-9	
P _{MAX}	Maximum Input Power for E _{LC} = 1 dB (Note 8)	f = 50 MHz	-8.85	-5.9		dBm
		f = 900 MHz	-9.3	-6.1		
		f = 1855 MHz	-8.3	-5.5		
		f = 2500 MHz	-6	-4.2		
		f = 3000 MHz	-5.4	-3.7		
		f = 3500 MHz	-7.2	-2.7		
P _{MIN}	Minimum Input Power for E _{LC} = 1 dB (Note 8)	f = 50 MHz		-40.3	-38.9	dBm
		f = 900 MHz		-44.2	-42.9	
		f = 1855 MHz		-42.9	-41.2	
		f = 2500 MHz		-40.4	-38.6	
		f = 3000 MHz		-38.4	-35.8	
		f = 3500 MHz		-35.3	-31.9	
DR	Dynamic Range for E _{LC} = 1 dB (Note 8)	f = 50 MHz	31.5	34.5		dB
		f = 900 MHz	34.4	38.1		
		f = 1855 MHz	34	37.4		
		f = 2500 MHz	33.8	36.1		
		f = 3000 MHz	32.4	34.8		
		f = 3500 MHz	26.2	32.7		

Note 1: Absolute Maximum Ratings indicate limits beyond which damage to the device may occur. Operating Ratings indicate conditions for which the device is intended to be functional, but specific performance is not guaranteed. For guaranteed specifications and the test conditions, see the Electrical Characteristics.

Note 2: Human body model, applicable std. MIL-STD-883, Method 3015.7. Machine model, applicable std. JESD22-A115-A (ESD MM std of JEDEC). Field-Induced Charge-Device Model, applicable std. JESD22-C101-C. (ESD FICDM std. of JEDEC)

Note 3: The maximum power dissipation is a function of T_{J(MAX)}, θ_{JA}. The maximum allowable power dissipation at any ambient temperature is P_D = (T_{J(MAX)} - T_A)/θ_{JA}. All numbers apply for packages soldered directly into a PC board.

Note 4: Electrical Table values apply only for factory testing conditions at the temperature indicated. Factory testing conditions result in very limited self-heating of the device such that T_J = T_A. No guarantee of parametric performance is indicated in the electrical tables under conditions of internal self-heating where T_J > T_A.

Note 5: Power in dBV = dBm + 13 when the impedance is 50Ω.

Note 6: All limits are guaranteed by test or statistical analysis.

Note 7: Typical values represent the most likely parametric norm as determined at the time of characterization. Actual typical values may vary over time and will also depend on the application and configuration. The typical values are not tested and are not guaranteed on shipped production material.

Note 8: All limits are guaranteed by design and measurements which are performed on a limited number of samples. Limits represent the mean ±3-sigma values. The typical value represents the statistical mean value.

Note 9: This parameter is guaranteed by design and/or characterization and is not tested in production.

Connection Diagram

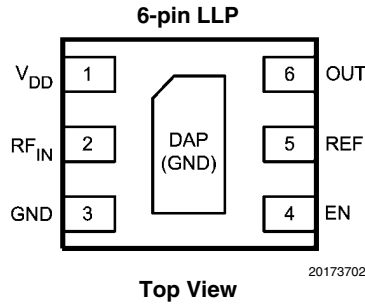

Pin Descriptions

	LLP6	Name	Description
Power Supply	1	V_{DD}	Positive Supply Voltage
	3	GND	Power Ground
Logic Input	4	EN	The device is enabled for EN = High, and brought to a low-power shutdown mode for EN = Low.
Analog Input	2	RF_{IN}	RF input signal to the detector, internally terminated with 50 Ω .
Output	5	REF	Reference output, for differential output measurement (without pedestal). Connected to inverting input of output amplifier.
	6	OUT	Ground referenced detector output voltage (linear in dB)
	DAP	GND	Ground (needs to be connected)

Ordering Information

Package	Part Number	Package Marking	Transport Media	NSC Drawing	Status
LLP-6	LMV221SD	A96	1k Units Tape and Reel	SDB06A	Released
	LMV221SDX		4.5k Units Tape and Reel		

Block Diagram

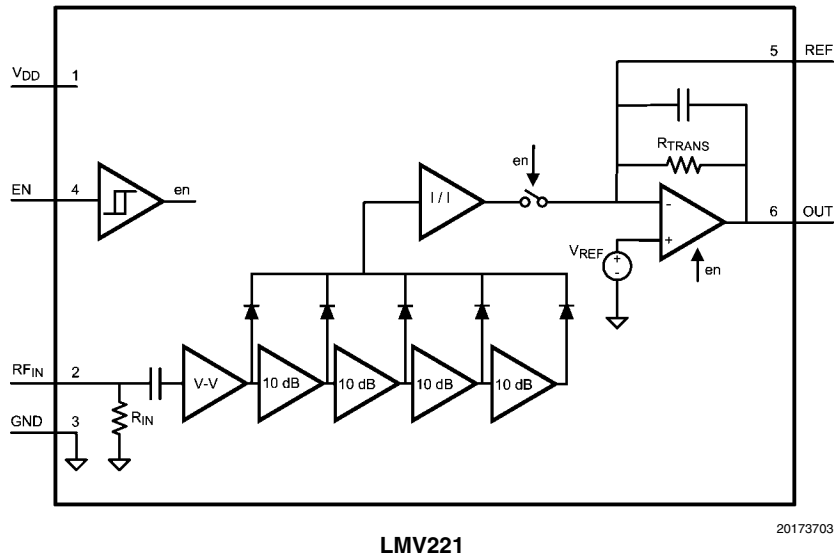

Typical Performance Characteristics

Unless otherwise specified, $V_{DD} = 2.7V$,

$T_A = 25^\circ C$, measured on a limited number of samples.

Supply Current vs. Supply Voltage

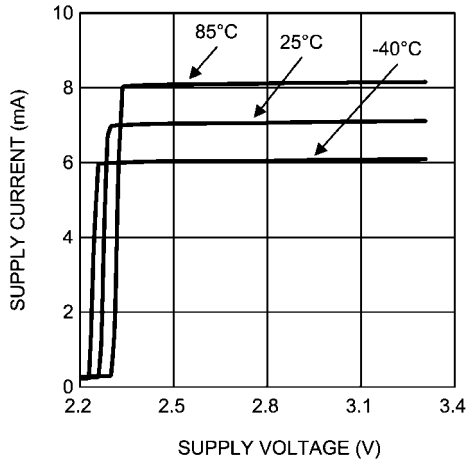

20173705

Supply Current vs. Enable Voltage

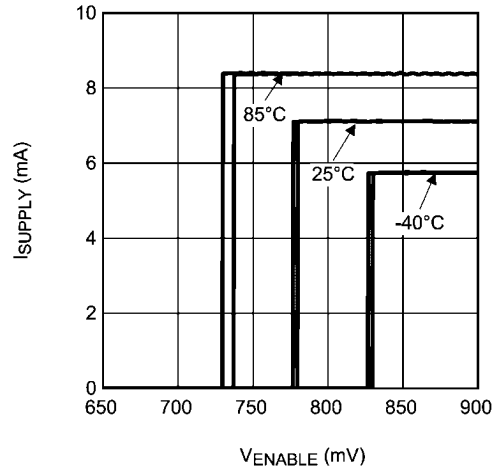

20173708

Output Voltage vs. RF input Power

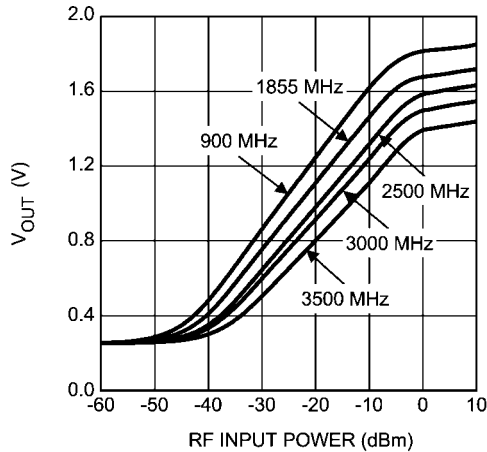

20173712

Log Slope vs. Frequency

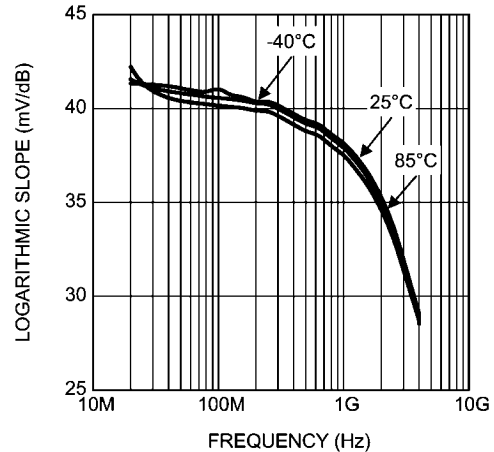

20173746

Log Intercept vs. Frequency

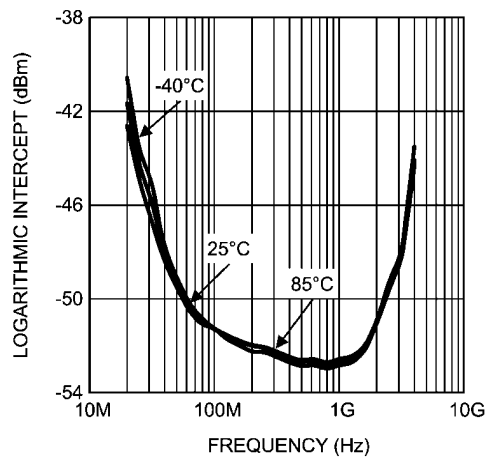

20173749

Output Voltage vs. Frequency

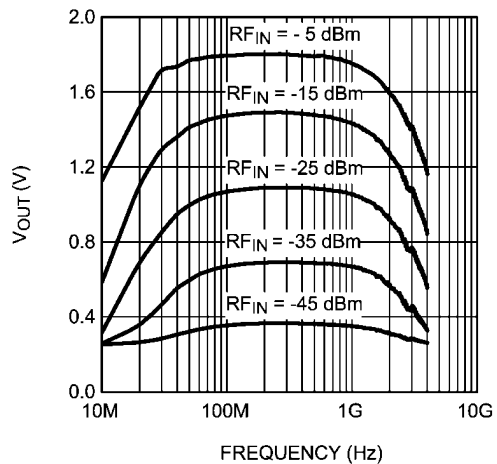

20173713

Mean Output Voltage and Log Conformance Error vs. RF Input Power at 50 MHz

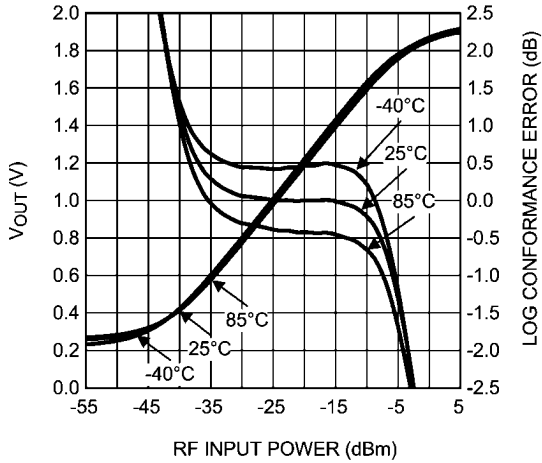

20173714

Mean Output Voltage and Log Conformance Error vs. RF Input Power at 900 MHz

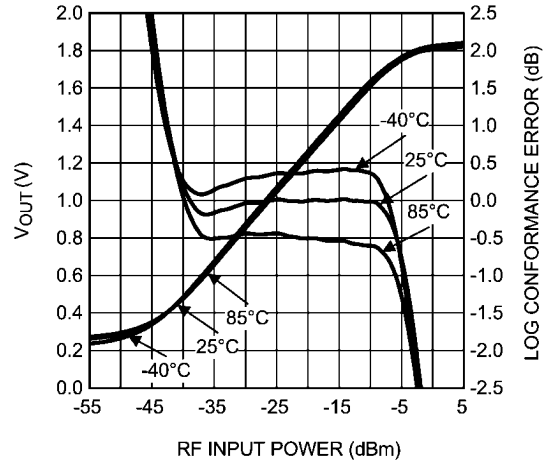

20173716

Mean Output Voltage and Log Conformance Error vs. RF Input Power at 1855 MHz

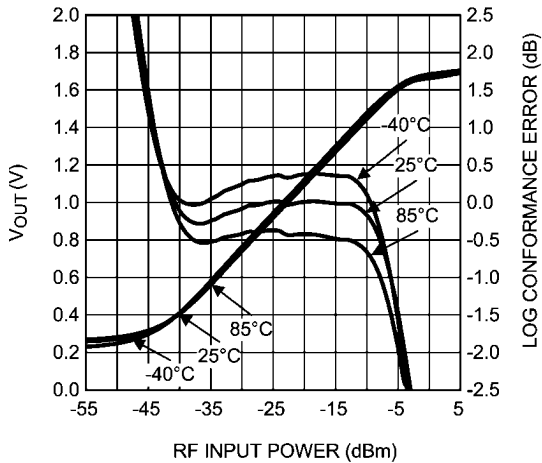

20173715

Mean Output Voltage and Log Conformance Error vs. RF Input Power at 2500 MHz

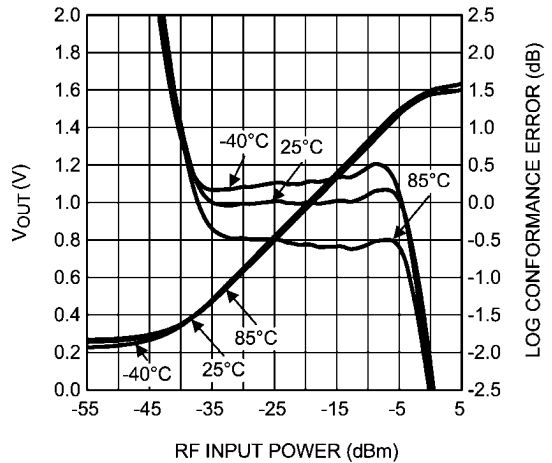

20173717

Mean Output Voltage and Log Conformance Error vs. RF Input Power at 3000 MHz

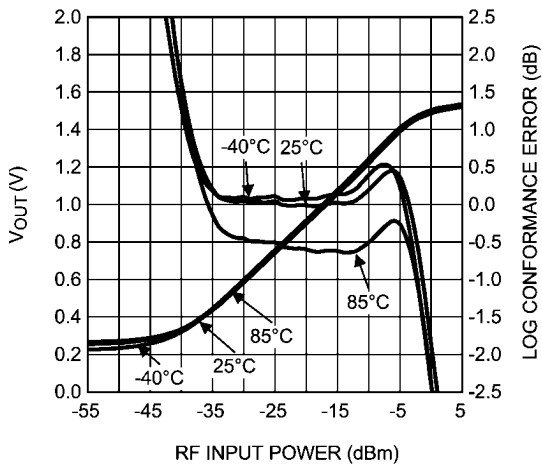

20173718

Mean Output Voltage and Log Conformance Error vs. RF Input Power at 3500 MHz

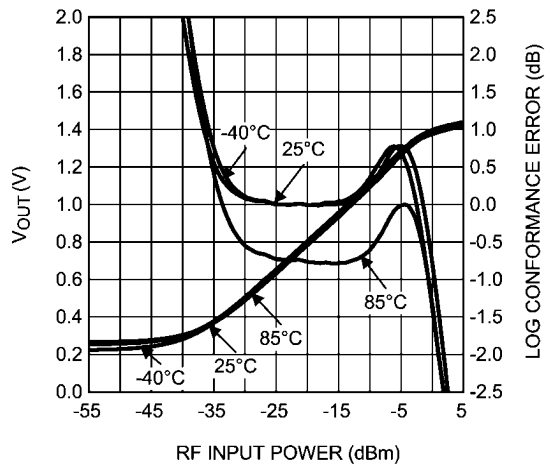

20173719

Log Conformance Error (Mean ± 3 sigma) vs. RF Input Power at 50 MHz

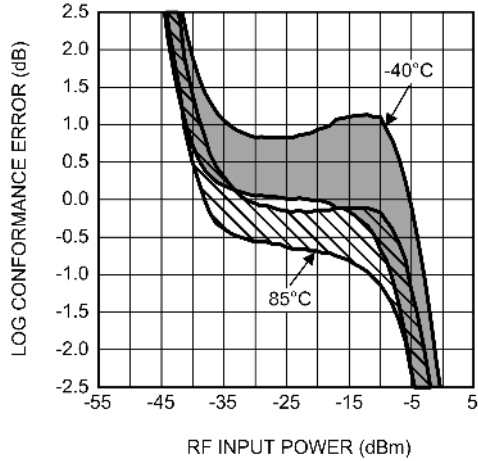

20173762

Log Conformance Error (Mean ± 3 sigma) vs. RF Input Power at 900 MHz

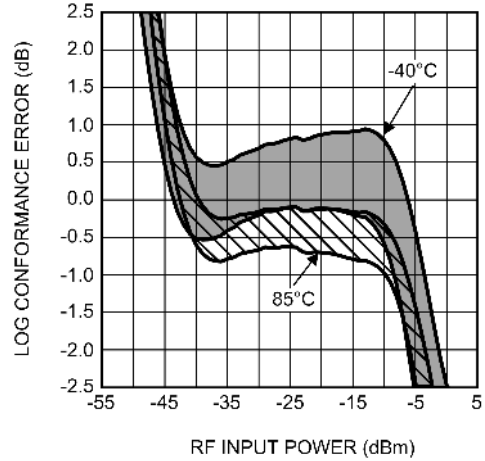

20173763

Log Conformance Error (Mean ± 3 sigma) vs. RF Input Power at 1855 MHz

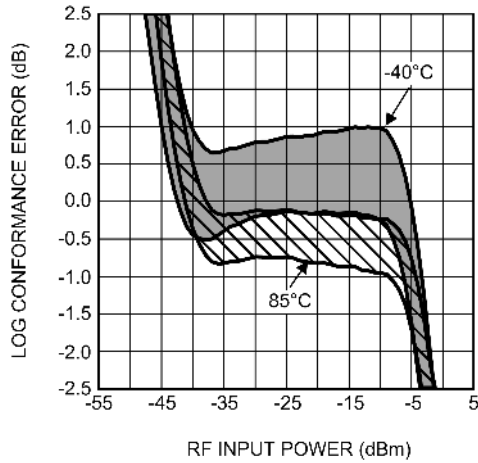

20173764

Log Conformance Error (Mean ± 3 sigma) vs. RF Input Power at 2500 MHz

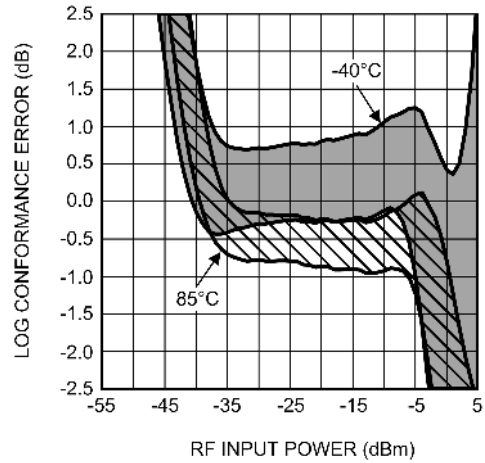

20173768

Log Conformance Error (Mean ± 3 sigma) vs. RF Input Power at 3000 MHz

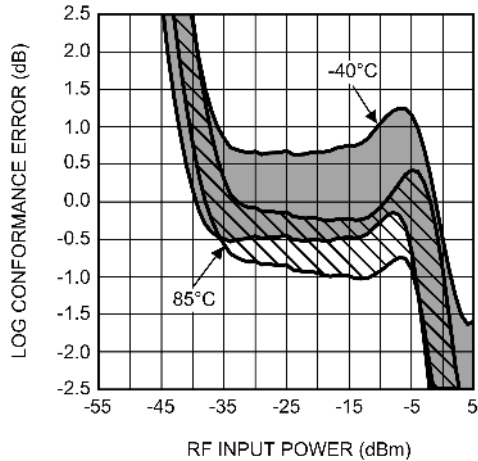

20173769

Log Conformance Error (Mean ± 3 sigma) vs. RF Input Power at 3500 MHz

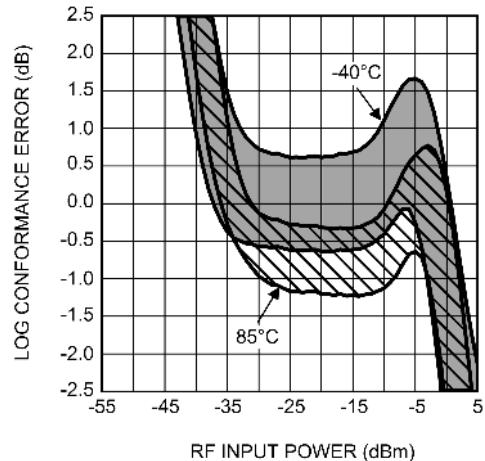

20173767

Mean Temperature Drift Error vs. RF Input Power at 50 MHz

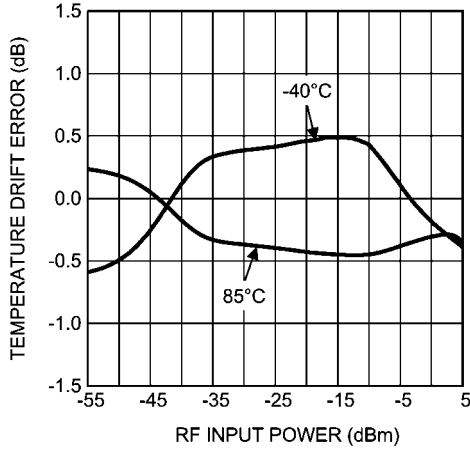

20173720

Mean Temperature Drift Error vs. RF Input Power at 900 MHz

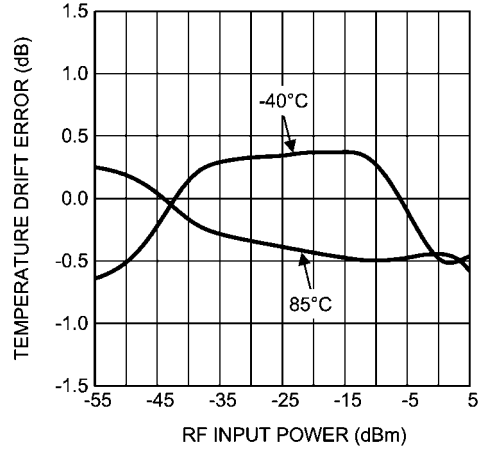

20173721

Mean Temperature Drift Error vs. RF Input Power at 1855 MHz

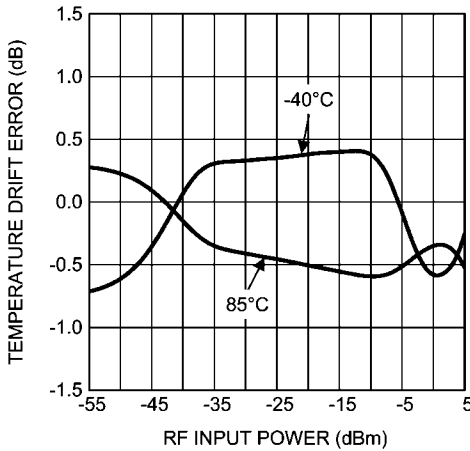

20173722

Mean Temperature Drift Error vs. RF Input Power at 2500 MHz

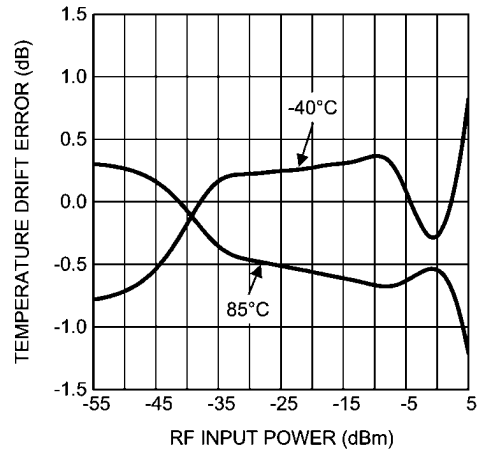

20173723

Mean Temperature Drift Error vs. RF Input Power at 3000 MHz

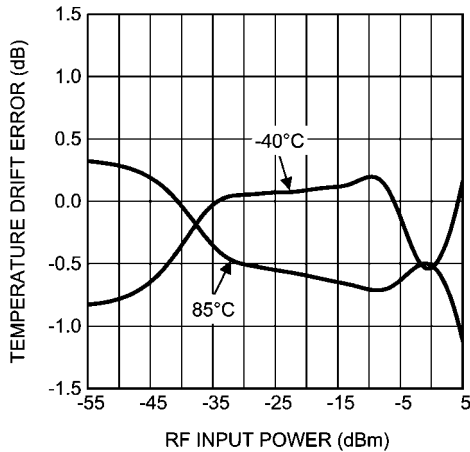

20173724

Mean Temperature Drift Error vs. RF Input Power at 3500 MHz

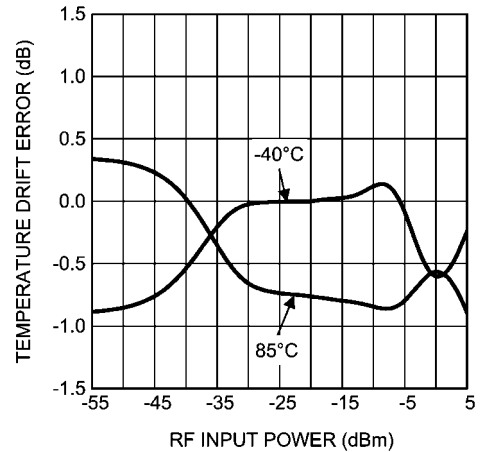

20173725

Temperature Drift Error (Mean ± 3 sigma) vs. RF Input Power at 50 MHz

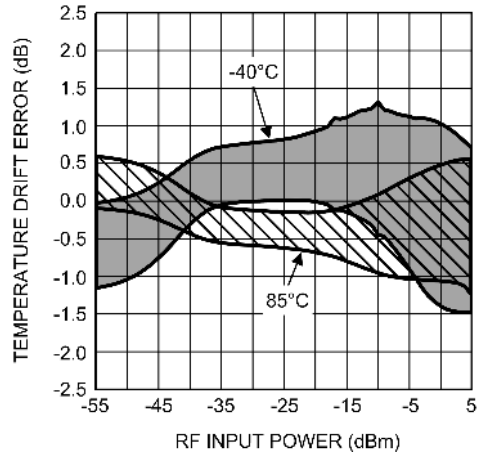

20173750

Temperature Drift Error (Mean ± 3 sigma) vs. RF Input Power at 900 MHz

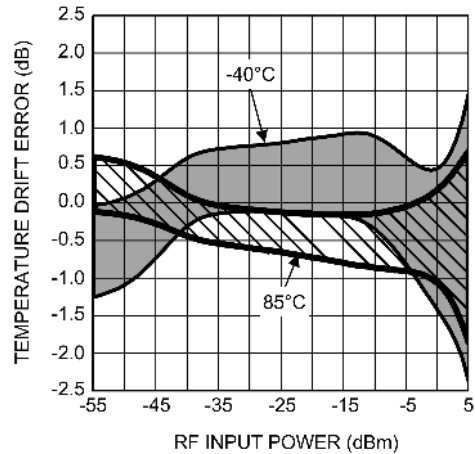

20173751

Temperature Drift Error (Mean ± 3 sigma) vs. RF Input Power at 1855 MHz

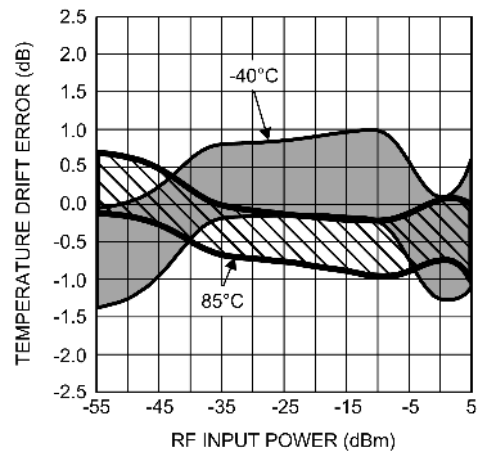

20173752

Temperature Drift Error (Mean ± 3 sigma) vs. RF Input Power at 2500 MHz

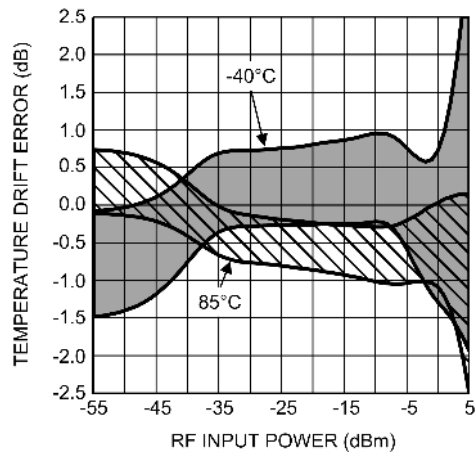

20173753

Temperature Drift Error (Mean ± 3 sigma) vs. RF Input Power at 3000 MHz

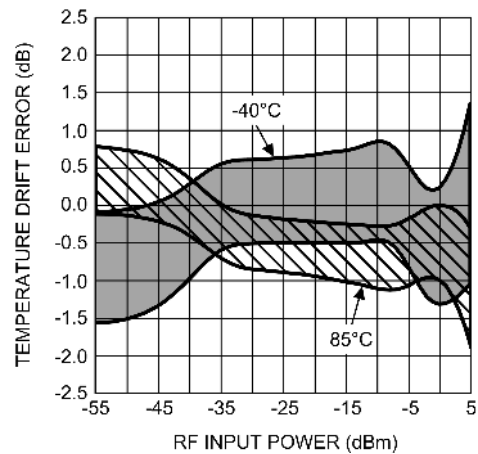

20173754

Temperature Drift Error (Mean ± 3 sigma) vs. RF Input Power at 3500 MHz

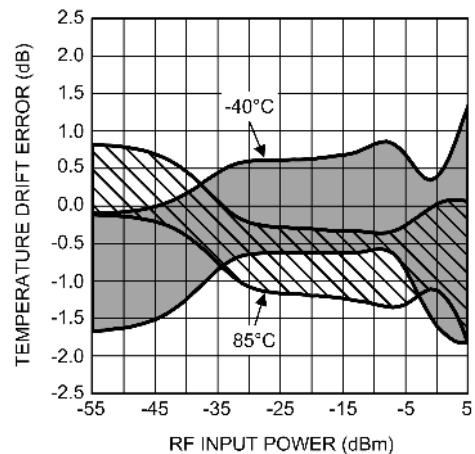

20173755

Error for 1 dB Input Power Step vs. RF Input Power at 50 MHz

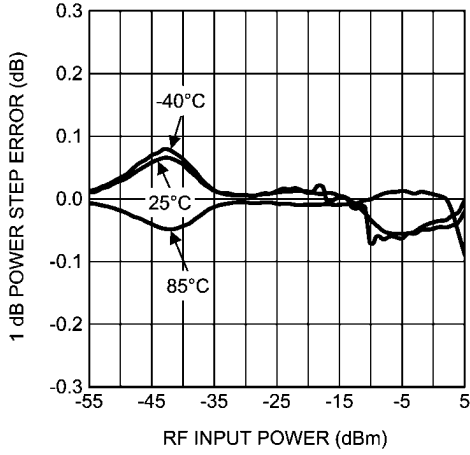

20173726

Error for 1 dB Input Power Step vs. RF Input Power at 900 MHz

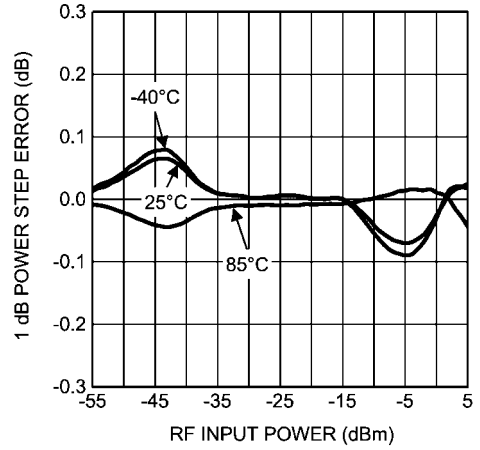

20173727

Error for 1 dB Input Power Step vs. RF Input Power at 1855 MHz

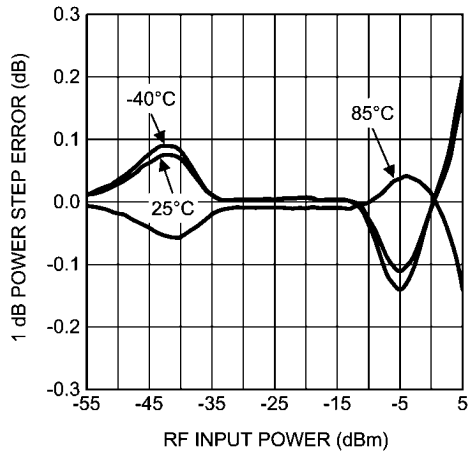

20173728

Error for 1 dB Input Power Step vs. RF Input Power at 2500 MHz

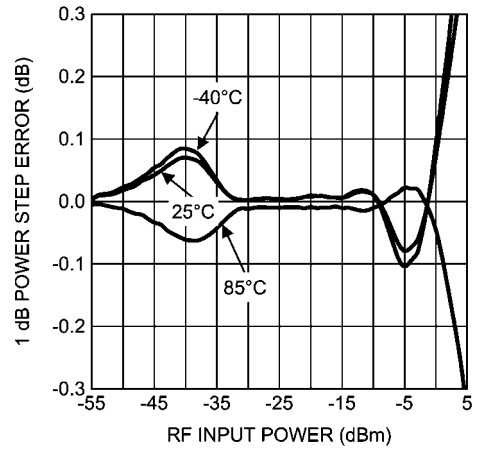

20173729

Error for 1 dB Input Power Step vs. RF Input Power at 3000 MHz

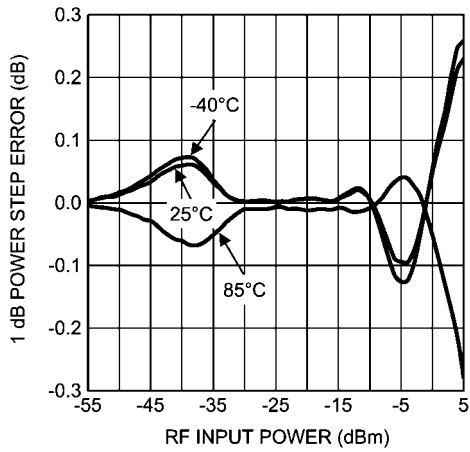

20173730

Error for 1 dB Input Power Step vs. RF Input Power at 3500 MHz

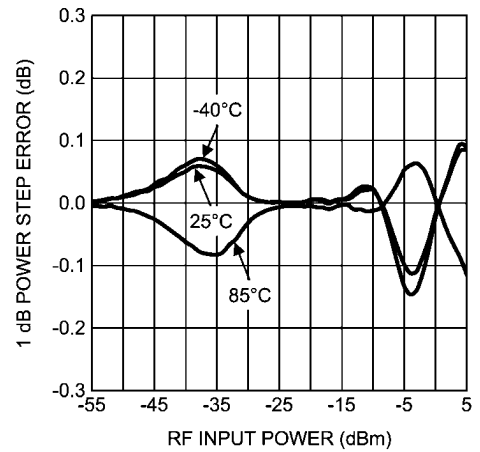

20173731

Error for 10 dB Input Power Step vs. RF Input Power at 50 MHz

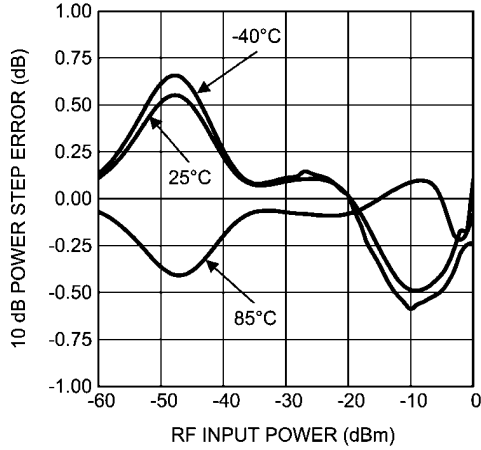

20173732

Error for 10 dB Input Power Step vs. RF Input Power at 900 MHz

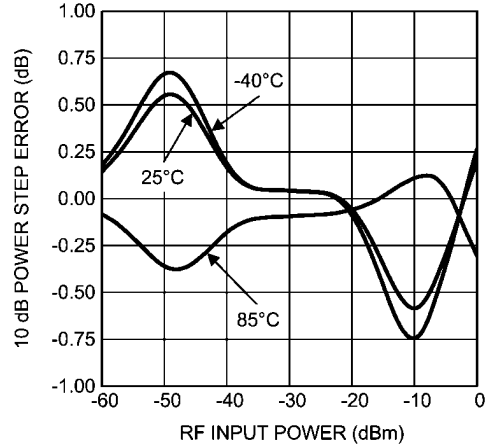

20173733

Error for 10 dB Input Power Step vs. RF Input Power at 1855 MHz

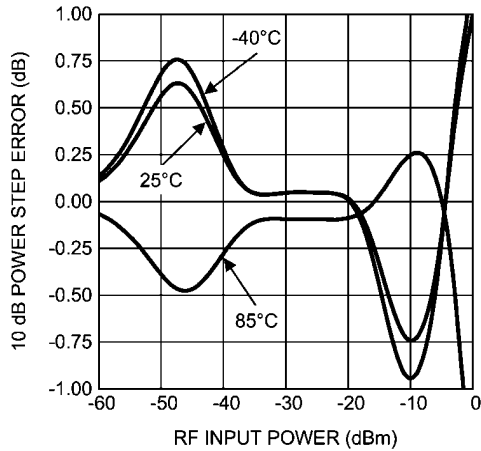

20173734

Error for 10 dB Input Power Step vs. RF Input Power at 2500 MHz

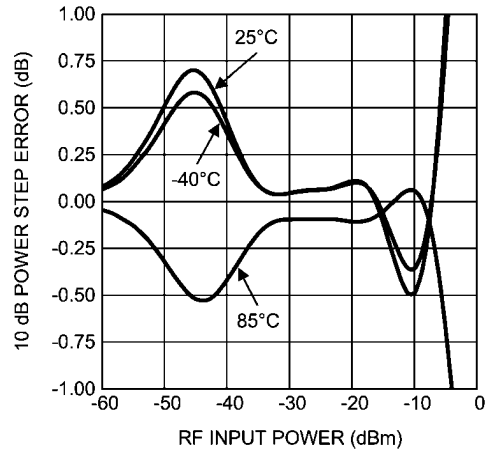

20173735

Error for 10 dB Input Power Step vs. RF Input Power at 3000 MHz

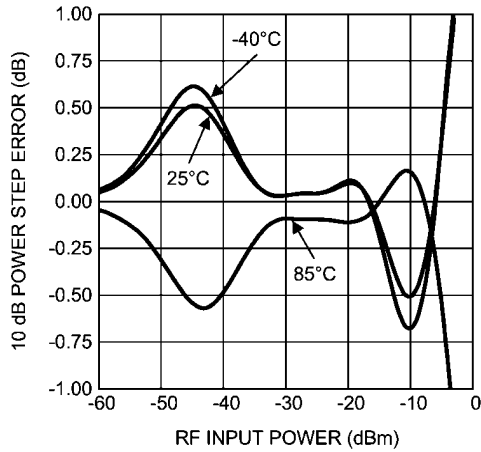

20173736

Error for 10 dB Input Power Step vs. RF Input Power at 3500 MHz

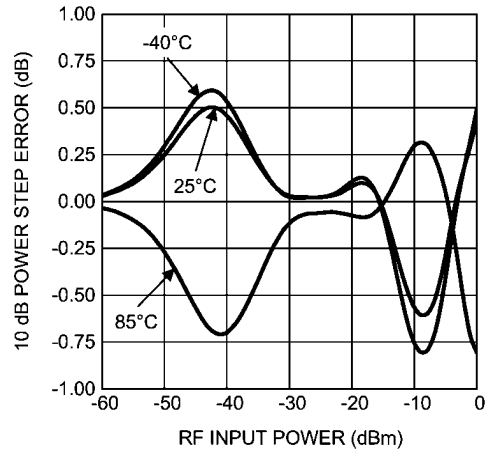

20173737

Mean Temperature Sensitivity vs. RF Input Power at 50 MHz

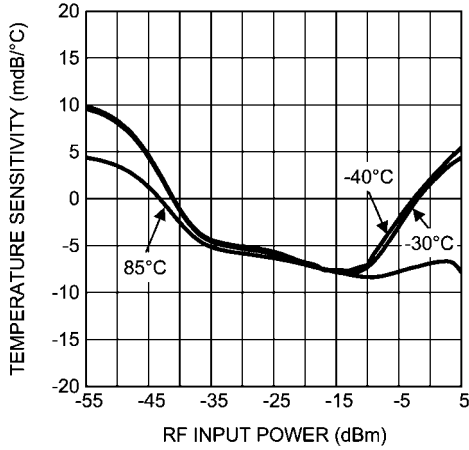

20173738

Mean Temperature Sensitivity vs. RF Input Power at 900 MHz

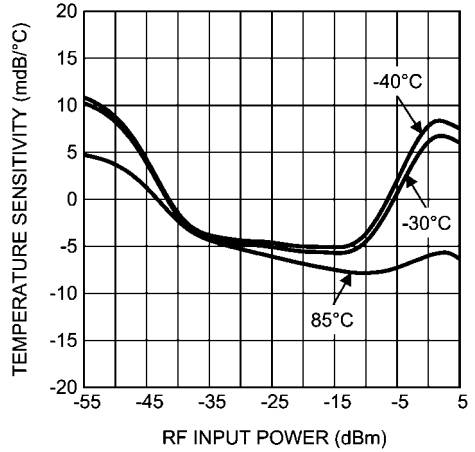

20173739

Mean Temperature Sensitivity vs. RF Input Power at 1855 MHz

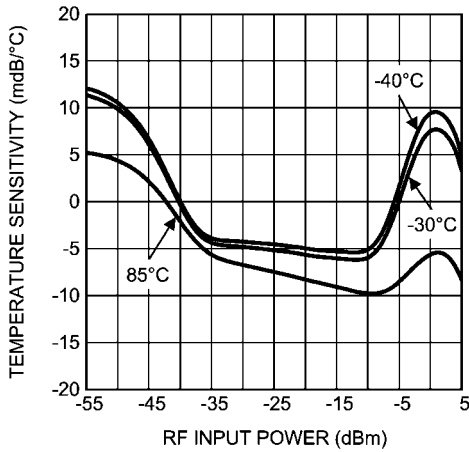

20173740

Mean Temperature Sensitivity vs. RF Input Power at 2500 MHz

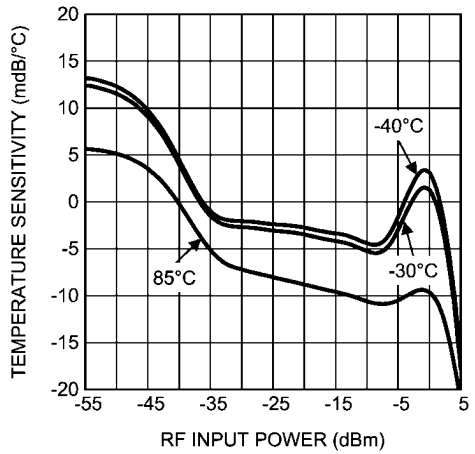

20173741

Mean Temperature Sensitivity vs. RF Input Power at 3000 MHz

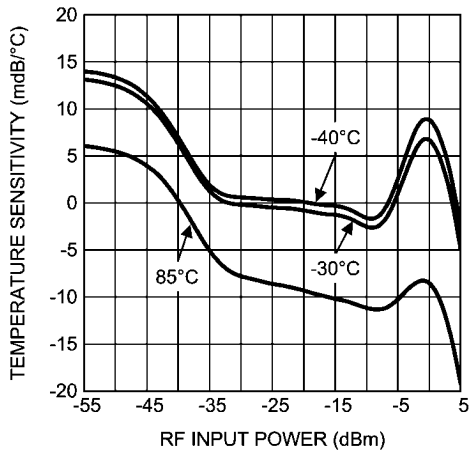

20173742

Mean Temperature Sensitivity vs. RF Input Power at 3500 MHz

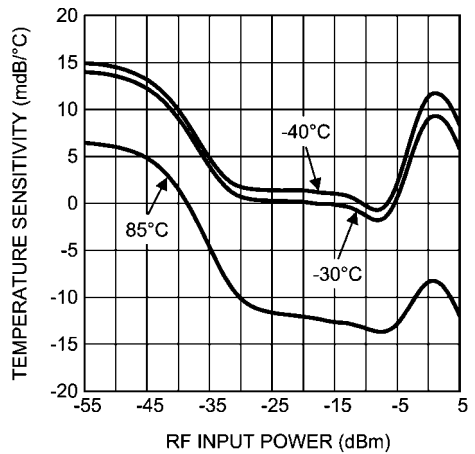

20173743

Temperature Sensitivity (Mean ± 3 sigma) vs. RF Input Power at 50 MHz

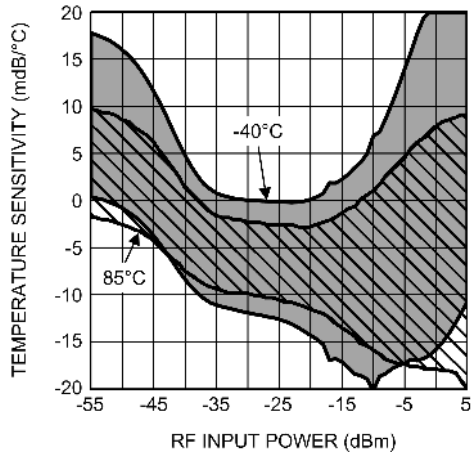

Temperature Sensitivity (Mean ± 3 sigma) vs. RF Input Power at 900 MHz

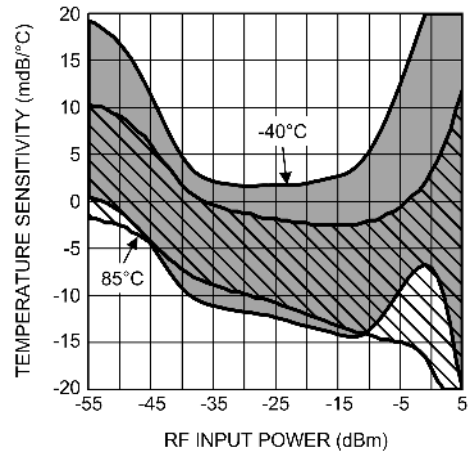

Temperature Sensitivity (Mean ± 3 sigma) vs. RF Input Power at 1855 MHz

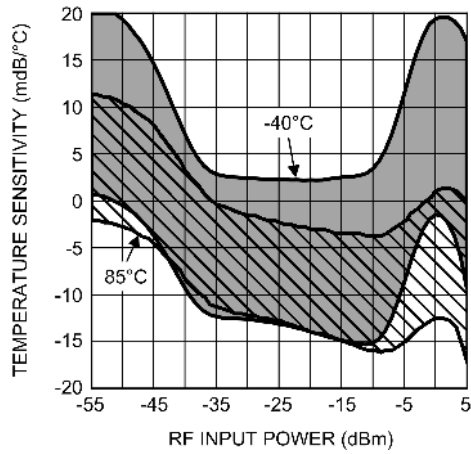

Temperature Sensitivity (Mean ± 3 sigma) vs. RF Input Power at 2500 MHz

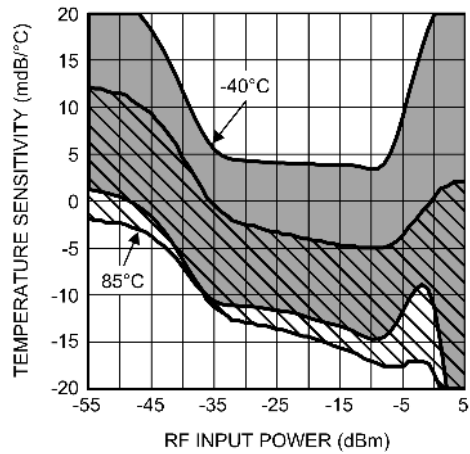

Temperature Sensitivity (Mean ± 3 sigma) vs. RF Input Power at 3000 MHz

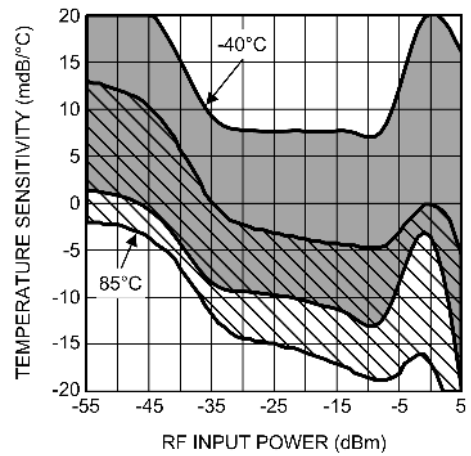

Temperature Sensitivity (Mean ± 3 sigma) vs. RF Input Power at 3500 MHz

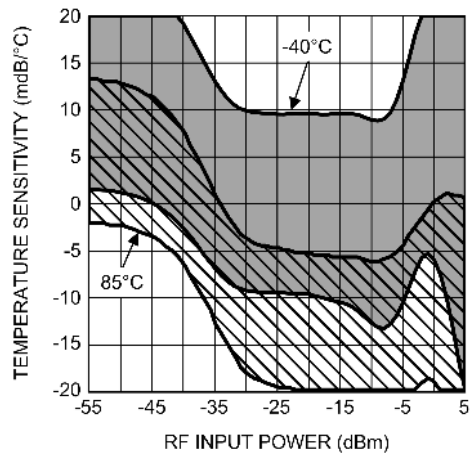

Output Voltage and Log Conformance Error vs. RF Input Power for various modulation types at 900 MHz

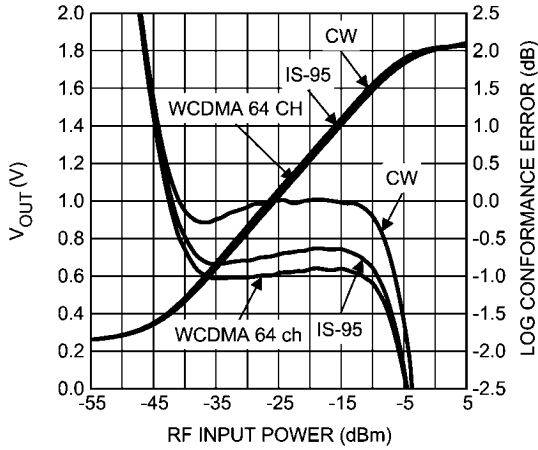

20173772

Output Voltage and Log Conformance Error vs. RF Input Power for various modulation types at 1855 MHz

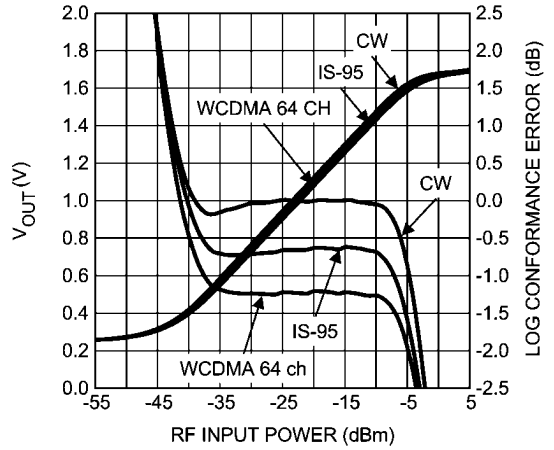

20173773

RF Input Impedance vs. Frequency (Resistance & Reactance)

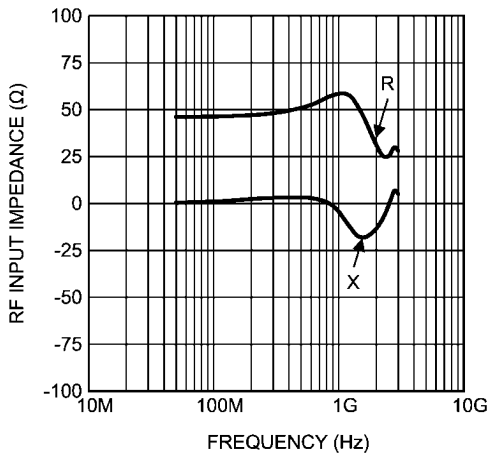

20173748

Output Noise Spectrum vs. Frequency

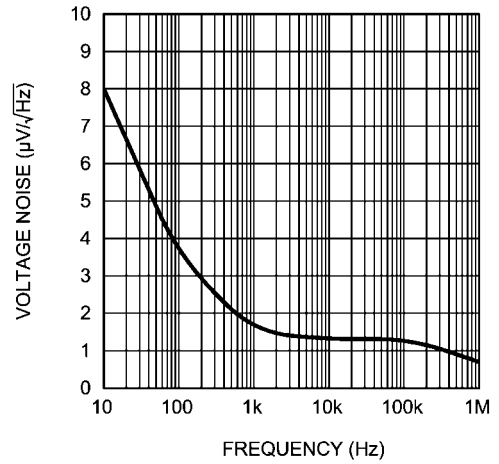

20173745

Power Supply Rejection Ratio vs. Frequency

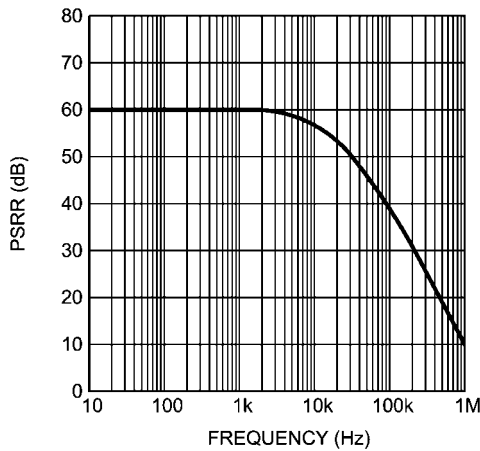

20173747

Output Amplifier Gain & Phase vs. Frequency

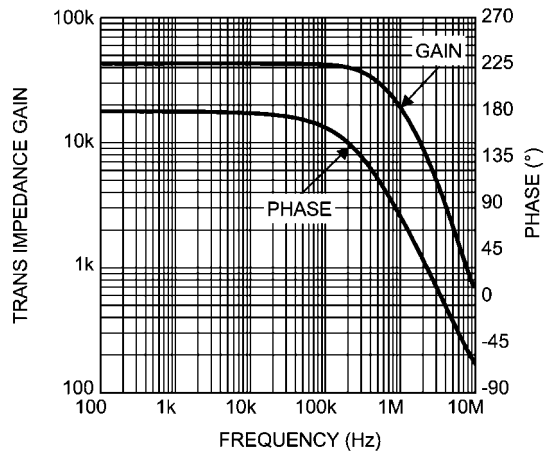

20173707

Sourcing Output Current vs. Output Voltage

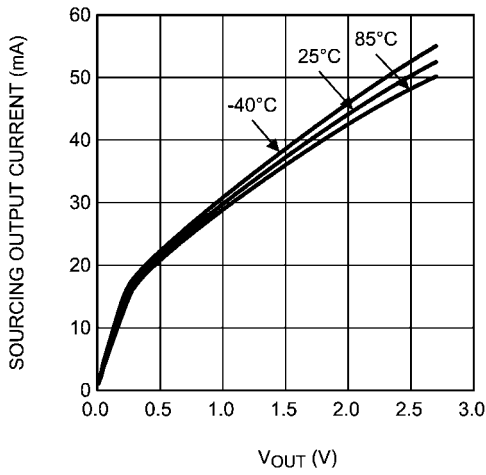

20173709

Sinking Output Current vs. Output Voltage

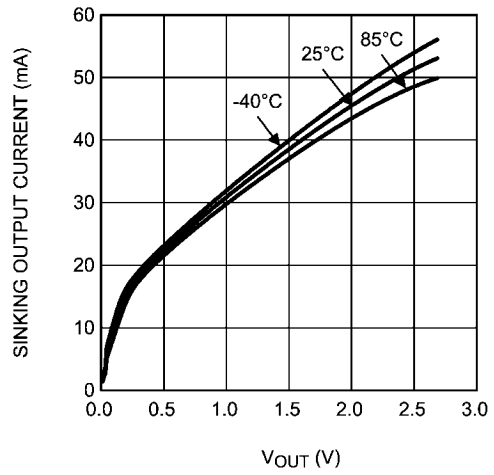

20173710

Output Voltage vs. Sourcing Current

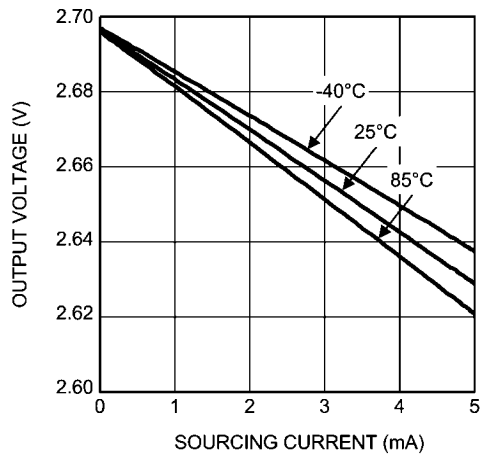

20173711

Output Voltage vs. Sinking Current

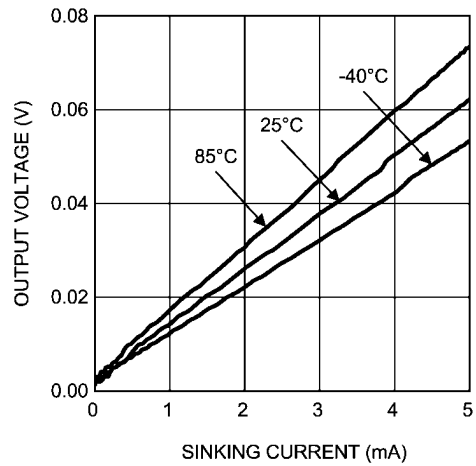

20173706

Application Notes

The LMV221 is a versatile logarithmic RF power detector suitable for use in power measurement systems. The LMV221 is particularly well suited for CDMA and UMTS applications. It produces a DC voltage that is a measure for the applied RF power.

This application section describes the behavior of the LMV221 and explains how accurate measurements can be performed. Besides this an overview is given of the interfacing options with the connected circuitry as well as the recommended layout for the LMV221.

1.0 FUNCTIONALITY AND APPLICATION OF RF POWER DETECTORS

This first section describes the functional behavior of RF power detectors and their typical application. Based on a number of key electrical characteristics of RF power detectors, section 1.1 discusses the functionality of RF power detectors in general and of the LMV221 LOG detector in particular. Subsequently, section 1.2 describes two important applications of the LMV221 detector.

1.1 Functionality of RF Power Detectors

An RF power detector is a device that produces a DC output voltage in response to the RF power level of the signal applied to its input. A wide variety of power detectors can be distinguished, each having certain properties that suit a particular application. This section provides an overview of the key characteristics of power detectors, and discusses the most important types of power detectors. The functional behavior of the LMV221 is discussed in detail.

1.1.1 Key Characteristics of RF Power Detectors.

Power detectors are used to accurately measure the power of a signal inside the application. The attainable accuracy of the measurement is therefore dependent upon the accuracy and predictability of the detector transfer function from the RF input power to the DC output voltage.

Certain key characteristics determine the accuracy of RF detectors and they are classified accordingly:

- Temperature Stability
- Dynamic Range
- Waveform Dependency
- Transfer Shape

Each of these aspects is discussed in further detail below.

Generally, the transfer function of RF power detectors is slightly temperature dependent. This temperature drift re-

duces the accuracy of the power measurement, because most applications are calibrated at room temperature. In such systems, the temperature drift significantly contributes to the overall system power measurement error. The temperature stability of the transfer function differs for the various types of power detectors. Generally, power detectors that contain only one or few semiconductor devices (diodes, transistors) operating at RF frequencies attain the best temperature stability.

The dynamic range of a power detector is the input power range for which it creates an accurately reproducible output signal. What is considered accurate is determined by the applied criterion for the detector accuracy; the detector dynamic range is thus always associated with certain power measurement accuracy. This accuracy is usually expressed as the deviation of its transfer function from a certain predefined relationship, such as "linear in dB" for LOG detectors and "square-law" transfer (from input RF voltage to DC output voltage) for Mean-Square detectors. For LOG-detectors, the dynamic range is often specified as the power range for which its transfer function follows the ideal linear-in-dB relationship with an error smaller than or equal to ± 1 dB. Again, the attainable dynamic range differs considerably for the various types of power detectors.

According to its definition, the average power is a metric for the average energy content of a signal and is not directly a function of the shape of the signal in time. In other words, the power contained in a 0 dBm sine wave is identical to the power contained in a 0 dBm square wave or a 0 dBm WCDMA signal; all these signals have the same average power. Depending on the internal detection mechanism, though, power detectors may produce a slightly different output signal in response to the aforementioned waveforms, even though their average power level is the same. This is due to the fact that not all power detectors strictly implement the definition formula for signal power, being the mean of the square of the signal. Most types of detectors perform some mixture of peak detection and average power detection. A waveform independent detector response is often desired in applications that exhibit a large variety of waveforms, such that separate calibration for each waveform becomes impractical.

The shape of the detector transfer function from the RF input power to the DC output voltage determines the required resolution of the ADC connected to it. The overall power measurement error is the combination of the error introduced by the detector, and the quantization error contributed by the ADC. The impact of the quantization error on the overall transfer's accuracy is highly dependent on the detector transfer shape, as illustrated in Figure 1.

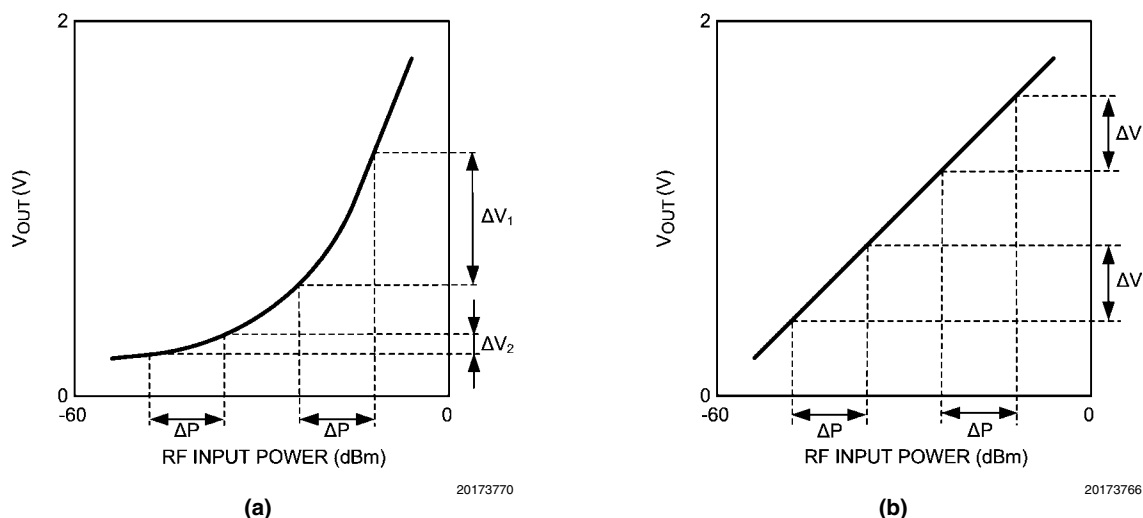

FIGURE 1. Convex Detector Transfer Function (a) and Linear Transfer Function (b)

Figure 1 shows two different representations of the detector transfer function. In both graphs the input power along the horizontal axis is displayed in dBm, since most applications specify power accuracy requirements in dBm (or dB). The figure on the left shows a convex detector transfer function, while the transfer function on the right hand side is linear (in dB). The slope of the detector transfer function — i.e. the detector conversion gain — is of key importance for the impact of the quantization error on the total measurement error. If the detector transfer function slope is low, a change, ΔP , in the input power results only in a small change of the detector output voltage, such that the quantization error will be relatively large. On the other hand, if the detector transfer function slope is high, the output voltage change for the same input power change will be large, such that the quantization error is small. The transfer function on the left has a very low slope at low input power levels, resulting in a relatively large quantization error. Therefore, to achieve accurate power measurement in this region, a high-resolution ADC is required. On the other hand, for high input power levels the quantization error will be very small due to the steep slope of the curve in this region. For accurate power measurement in this region, a much lower ADC resolution is sufficient. The curve on the right has a constant slope over the power range of interest, such that the required ADC resolution for a certain measurement accuracy is constant. For this reason, the LOG-linear curve on the right will generally lead to the lowest ADC resolution requirements for certain power measurement accuracy.

1.1.2 Types of RF Power Detectors

Three different detector types are distinguished based on the four characteristics previously discussed:

- Diode Detector
- (Root) Mean Square Detector
- Logarithmic Detector

These three types of detectors are discussed in the following sections. Advantages and disadvantages will be presented for each type.

Diode Detector

A diode is one of the simplest types of RF detectors. As depicted in Figure 2, the diode converts the RF input voltage into

a rectified current. This unidirectional current charges the capacitor. The RC time constant of the resistor and the capacitor determines the amount of filtering applied to the rectified (detected) signal.

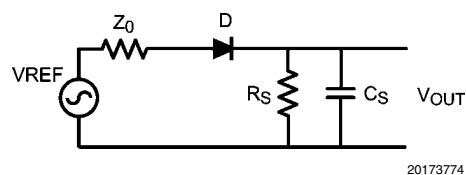

FIGURE 2. Diode Detector

The advantages and disadvantages can be summarized as follows:

- The temperature stability of the diode detectors is generally very good, since they contain only one semiconductor device that operates at RF frequencies.
- The dynamic range of diode detectors is poor. The conversion gain from the RF input power to the output voltage quickly drops to very low levels when the input power decreases. Typically a dynamic range of 20 – 25 dB can be realized with this type of detector.
- The response of diode detectors is waveform dependent. As a consequence of this dependency its output voltage for e.g. a 0 dBm WCDMA signal is different than for a 0 dBm unmodulated carrier. This is due to the fact that the diode measures peak power instead of average power. The relation between peak power and average power is dependent on the wave shape.
- The transfer shape of diode detectors puts high requirements on the resolution of the ADC that reads their output voltage. Especially at low input power levels a very high ADC resolution is required to achieve sufficient power measurement accuracy (See Figure 1, left side).

(Root) Mean Square Detector

This type of detector is particularly suited for the power measurements of RF modulated signals that exhibits large peak to average power ratio variations. This is because its opera-

tion is based on direct determination of the average power and not – like the diode detector – of the peak power.

The advantages and disadvantages can be summarized as follows:

- The temperature stability of (R)MS detectors is almost as good as the temperature stability of the diode detector; only a small part of the circuit operates at RF frequencies, while the rest of the circuit operates at low frequencies.
- The dynamic range of (R)MS detectors is limited. The lower end of the dynamic range is limited by internal device offsets.
- The response of (R)MS detectors is highly waveform independent. This is a key advantage compared to other types of detectors in applications that employ signals with high peak-to-average power variations. For example, the (R)MS detector response to a 0 dBm WCDMA signal and a 0 dBm unmodulated carrier is essentially equal.
- The transfer shape of R(MS) detectors has many similarities with the diode detector and is therefore subject to similar disadvantages with respect to the ADC resolution requirements (See Figure 1, left side).

Logarithmic Detectors

The transfer function of a logarithmic detector has a linear in dB response, which means that the output voltage changes linearly with the RF power in dBm. This is convenient since most communication standards specify transmit power levels in dBm as well.

The advantages and disadvantages can be summarized as follows:

- The temperature stability of the LOG detector transfer function is generally not as good as the stability of diode and R(MS) detectors. This is because a significant part of the circuit operates at RF frequencies.
- The dynamic range of LOG detectors is usually much larger than that of other types of detectors.
- Since LOG detectors perform a kind of peak detection their response is wave form dependent, similar to diode detectors.
- The transfer shape of LOG detectors puts the lowest possible requirements on the ADC resolution (See Figure 1, right side).

1.1.3 Characteristics of the LMV221

The LMV221 is a Logarithmic RF power detector with approximately 40 dB dynamic range. This dynamic range plus its logarithmic behavior make the LMV221 ideal for various applications such as wireless transmit power control for CDMA and UMTS applications. The frequency range of the LMV221 is from 50 MHz to 3.5 GHz, which makes it suitable for various applications.

The LMV221 transfer function is accurately temperature compensated. This makes the measurement accurate for a wide temperature range. Furthermore, the LMV221 can easily be connected to a directional coupler because of its 50 ohm input termination. The output range is adjustable to fit the ADC input range. The detector can be switched into a power saving shutdown mode for use in pulsed conditions.

1.2 Applications of RF Power Detectors

RF power detectors can be used in a wide variety of applications. This section discusses two application. The first example shows the LMV221 in a transmit power control loop, the second application measures the voltage standing wave ratio (VSWR).

1.2.1 Transmit Power Control Loop

The key benefit of a transmit power control loop circuit is that it makes the transmit power insensitive to changes in the Power Amplifier (PA) gain control function, such as changes due to temperature drift. When a control loop is used, the transfer function of the PA is eliminated from the overall transfer function. Instead, the overall transfer function is determined by the power detector. The overall transfer function accuracy depends thus on the RF detector accuracy. The LMV221 is especially suited for this application, due to the accurate temperature stability of its transfer function.

Figure 3 shows a block diagram of a typical transmit power control system. The output power of the PA is measured by the LMV221 through a directional coupler. The measured output voltage of the LMV221 is filtered and subsequently digitized by the ADC inside the baseband chip. The baseband adjusts the PA output power level by changing the gain control signal of the RF VGA accordingly. With an input impedance of 50Ω, the LMV221 can be directly connected to a 30 dB directional coupler without the need for an additional external attenuator. The setup can be adjusted to various PA output ranges by selection of a directional coupler with the appropriate coupling factor.

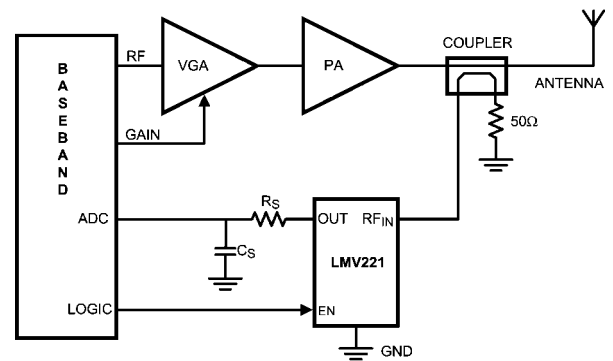

20173797

FIGURE 3. Transmit Power Control System

1.2.2 Voltage Standing Wave Ratio Measurement

Transmission in RF systems requires matched termination by the proper characteristic impedance at the transmitter and receiver side of the link. In wireless transmission systems though, matched termination of the antenna can rarely be achieved. The part of the transmitted power that is reflected at the antenna bounces back toward the PA and may cause standing waves in the transmission line between the PA and the antenna. These standing waves can attain unacceptable levels that may damage the PA. A Voltage Standing Wave Ratio (VSWR) measurement is used to detect such an occasion. It acts as an alarm function to prevent damage to the transmitter.

VSWR is defined as the ratio of the maximum voltage divided by the minimum voltage at a certain point on the transmission line:

$$VSWR = \frac{1 + |\Gamma|}{1 - |\Gamma|}$$

Where $\Gamma = V_{\text{REFLECTED}} / V_{\text{FORWARD}}$ denotes the reflection coefficient.

This means that to determine the VSWR, both the forward (transmitted) and the reflected power levels have to be mea-

sured. This can be accomplished by using two LMV221 RF power detectors according to Figure 4. A directional coupler is used to separate the forward and reflected power waves on the transmission line between the PA and the antenna. One secondary output of the coupler provides a signal proportional to the forward power wave, the other secondary output provides a signal proportional to the reflected power wave. The outputs of both RF detectors that measure these signals are connected to a micro-controller or baseband that calculates the VSWR from the detector output signals.

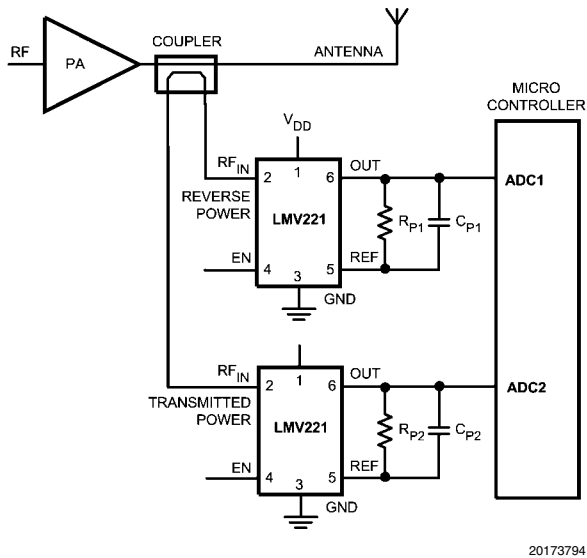

FIGURE 4. VSWR Application

2.0 ACCURATE POWER MEASUREMENT

The power measurement accuracy achieved with a power detector is not only determined by the accuracy of the detector itself, but also by the way it is integrated into the application. In many applications some form of calibration is employed to improve the accuracy of the overall system beyond the intrinsic accuracy provided by the power detector. For example, for LOG-detectors calibration can be used to eliminate part to part spread of the LOG-slope and LOG-intercept from the overall power measurement system, thereby improving its power measurement accuracy.

This section shows how calibration techniques can be used to improve the accuracy of a power measurement system beyond the intrinsic accuracy of the power detector itself. The main focus of the section is on power measurement systems using LOG-detectors, specifically the LMV221, but the more generic concepts can also be applied to other power detectors. Other factors influencing the power measurement accuracy, such as the resolution of the ADC reading the detector output signal will not be considered here since they are not fundamentally due to the power detector.

2.1 Concept of Power Measurements

Power measurement systems generally consists of two clearly distinguishable parts with different functions:

1. A power detector device, that generates a DC output signal (voltage) in response to the power level of the (RF) signal applied to its input.
2. An “estimator” that converts the measured detector output signal into a (digital) numeric value representing the power level of the signal at the detector input.

A sketch of this conceptual configuration is depicted in Figure 5 .

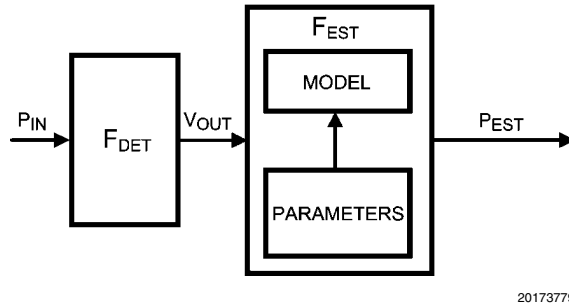

FIGURE 5. Generic Concept of a Power Measurement System

The core of the estimator is usually implemented as a software algorithm, receiving a digitized version of the detector output voltage. Its transfer F_{EST} from detector output voltage to a numerical output should be equal to the inverse of the detector transfer F_{DET} from (RF) input power to DC output voltage. If the power measurement system is ideal, i.e. if no errors are introduced into the measurement result by the detector or the estimator, the measured power P_{EST} - the output of the estimator - and the actual input power P_{IN} should be identical. In that case, the measurement error E , the difference between the two, should be identically zero:

$$E = P_{EST} - P_{IN} \equiv 0$$

$$\Leftrightarrow P_{EST} = F_{EST}[F_{DET}(P_{IN})] = P_{IN}$$

$$\Leftrightarrow F_{EST}(V_{OUT}) = F_{DET}^{-1}(V_{OUT})$$

From the expression above it follows that one would design the F_{EST} transfer function to be the inverse of the F_{DET} transfer function.

In practice the power measurement error will not be zero, due to the following effects:

- The detector transfer function is subject to various kinds of random errors that result in uncertainty in the detector output voltage; the detector transfer function is not exactly known.
- The detector transfer function might be too complicated to be implemented in a practical estimator.

The function of the estimator is then to estimate the input power P_{IN} , i.e. to produce an output P_{EST} such that the power measurement error is - on average - minimized, based on the following information:

1. Measurement of the not completely accurate detector output voltage V_{OUT}
2. Knowledge about the detector transfer function F_{DET} , for example the shape of the transfer function, the types of errors present (part-to-part spread, temperature drift) etc.

Obviously the total measurement accuracy can be optimized by minimizing the uncertainty in the detector output signal (i.e. select an accurate power detector), and by incorporating as much accurate information about the detector transfer function into the estimator as possible.

The knowledge about the detector transfer function is condensed into a mathematical model for the detector transfer function, consisting of:

- A formula for the detector transfer function.

- Values for the parameters in this formula.

The values for the parameters in the model can be obtained in various ways. They can be based on measurements of the detector transfer function in a precisely controlled environment (parameter extraction). If the parameter values are separately determined for each individual device, errors like part-to-part spread are eliminated from the measurement system. Obviously, errors may occur when the operating conditions of the detector (e.g. the temperature) become significantly different from the operating conditions during calibration (e.g. room temperature). Subsequent sections will discuss examples of simple estimators for power measurements that result in a number of commonly used metrics for the power measurement error: the LOG-conformance error, the temperature drift error, the temperature sensitivity and differential power error.

2.2 LOG-Conformance Error

Probably the simplest power measurement system that can be realized is obtained when the LOG-detector transfer function is modelled as a perfect linear-in-dB relationship between the input power and output voltage:

$$V_{OUT,MOD} = F_{DET,MOD}(P_{IN}) = K_{SLOPE}(P_{IN} - P_{INTERCEPT})$$

in which K_{SLOPE} represents the LOG-slope and $P_{INTERCEPT}$ the LOG-intercept. The estimator based on this model implements the inverse of the model equation, i.e.

$$P_{EST} = F_{EST}(V_{OUT}) = \frac{V_{OUT}}{K_{SLOPE}} + P_{INTERCEPT}$$

The resulting power measurement error, the LOG-conformance error, is thus equal to:

$$\begin{aligned} E_{LCE} &= P_{EST} - P_{IN} = \frac{V_{OUT}}{K_{SLOPE}} - (P_{IN} - P_{INTERCEPT}) \\ &= \frac{V_{OUT} - V_{OUT,MOD}}{K_{SLOPE}} \end{aligned}$$

The most important contributions to the LOG-conformance error are generally:

- The deviation of the actual detector transfer function from an ideal Logarithm (the transfer function is nonlinear in dB).
- Drift of the detector transfer function over various environmental conditions, most importantly temperature; K_{SLOPE} and $P_{INTERCEPT}$ are usually determined for room temperature only.
- Part-to-part spread of the (room temperature) transfer function.

The latter component is conveniently removed by means of calibration, i.e. if the LOG slope and LOG-intercept are determined for each individual detector device (at room temperature). This can be achieved by measurement of the detector output voltage - at room temperature - for a series of different power levels in the LOG-linear range of the detector transfer function. The slope and intercept can then be determined by means of linear regression.

An example of this type of error and its relationship to the detector transfer function is depicted in Figure 6.

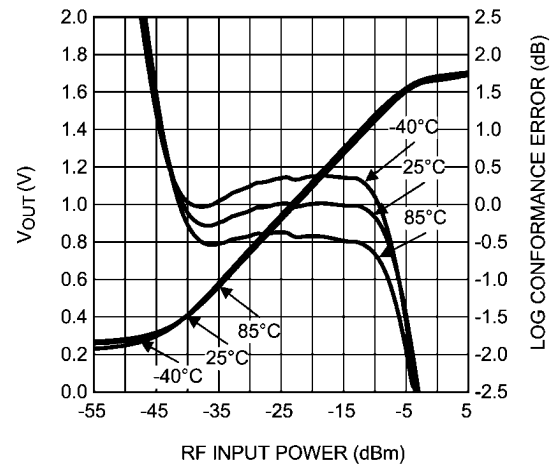

20173715

FIGURE 6. LOG-Conformance Error and LOG-Detector Transfer Function

In the center of the detector's dynamic range, the LOG-conformance error is small, especially at room temperature; in this region the transfer function closely follows the linear-in-dB relationship while K_{SLOPE} and $P_{INTERCEPT}$ are determined based on room temperature measurements. At the temperature extremes the error in the center of the range is slightly larger due to the temperature drift of the detector transfer function. The error rapidly increases toward the top and bottom end of the detector's dynamic range; here the detector saturates and its transfer function starts to deviate significantly from the ideal LOG-linear model. The detector dynamic range is usually defined as the power range for which the LOG conformance error is smaller than a specified amount. Often an error of ± 1 dB is used as a criterion.

2.3 Temperature Drift Error

A more accurate power measurement system can be obtained if the first error contribution, due to the deviation from the ideal LOG-linear model, is eliminated. This is achieved if the actual measured detector transfer function at room temperature is used as a model for the detector, instead of the ideal LOG-linear transfer function used in the previous section.

The formula used for such a detector is:

$$V_{OUT,MOD} = F_{DET}(P_{IN}, T_0)$$

where T_0 represents the temperature during calibration (room temperature). The transfer function of the corresponding estimator is thus the inverse of this:

$$P_{EST} = F_{DET}^{-1}[V_{OUT}(T), T_0]$$

In this expression $V_{OUT}(T)$ represents the measured detector output voltage at the operating temperature T .

The resulting measurement error is only due to drift of the detector transfer function over temperature, and can be expressed as:

$$\begin{aligned} E_{DRIFT}(T, T_0) &= P_{EST} - P_{IN} = F_{DET}^{-1}[V_{OUT}(T), T_0] - P_{IN} \\ &= F_{DET}^{-1}[V_{OUT}(T), T_0] - F_{DET}^{-1}[V_{OUT}(T), T] \end{aligned}$$

Unfortunately, the (numeric) inverse of the detector transfer function at different temperatures makes this expression rather impractical. However, since the drift error is usually small $V_{OUT}(T)$ is only slightly different from $V_{OUT}(T_0)$. This means that we can apply the following approximation:

$$E_{DRIFT}(T, T_0) \approx E_{DRIFT}(T_0, T_0) + (T - T_0) \frac{\partial}{\partial T} [F_{DET}^{-1}[V_{OUT}(T), T_0] - F_{DET}^{-1}[V_{OUT}(T), T]]$$

This expression is easily simplified by taking the following considerations into account:

- The drift error at the calibration temperature $E(T_0, T_0)$ equals zero (by definition).
- The estimator transfer $F_{DET}(V_{OUT}, T_0)$ is not a function of temperature; the estimator output changes over temperature only due to the temperature dependence of V_{OUT} .
- The actual detector input power P_{IN} is not temperature dependent (in the context of this expression).
- The derivative of the estimator transfer function to V_{OUT} equals approximately $1/K_{SLOPE}$ in the LOG-linear region of the detector transfer function (the region of interest).

Using this, we arrive at:

$$\begin{aligned} E_{DRIFT}(T, T_0) &\approx (T - T_0) \frac{\partial}{\partial T} F_{DET}^{-1}[V_{OUT}(T), T_0] \\ &= (T - T_0) \frac{\partial V_{OUT}(T)}{\partial T} \frac{\partial}{\partial V_{OUT}} F_{DET}^{-1}[V_{OUT}(T), T_0] \\ &\approx \frac{V_{OUT}(T) - V_{OUT}(T_0)}{K_{SLOPE}} \end{aligned}$$

This expression is very similar to the expression of the LOG-conformance error determined previously. The only difference is that instead of the output of the ideal LOG-linear model, the actual detector output voltage at the calibration temperature is now subtracted from the detector output voltage at the operating temperature.

Figure 7 depicts an example of the drift error.

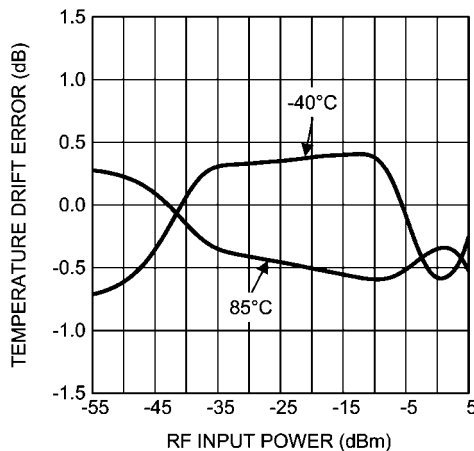

20173722

FIGURE 7. Temperature Drift Error of the LMV221 at f = 1855 MHz

In agreement with the definition, the temperature drift error is zero at the calibration temperature. Further, the main difference with the LOG-conformance error is observed at the top and bottom end of the detection range; instead of a rapid increase the drift error settles to a small value at high and low input power levels due to the fact that the detector saturation levels are relatively temperature independent.

In a practical application it may not be possible to use the exact inverse detector transfer function as the algorithm for the estimator. For example it may require too much memory and/or too much factory calibration time. However, using the ideal LOG-linear model in combination with a few extra data points at the top and bottom end of the detection range - where the deviation is largest - can already significantly reduce the power measurement error.

2.4 Temperature Compensation

A further reduction of the power measurement error is possible if the operating temperature is measured in the application. For this purpose, the detector model used by the estimator should be extended to cover the temperature dependency of the detector.

Since the detector transfer function is generally a smooth function of temperature (the output voltage changes gradually over temperature), the temperature is in most cases adequately modeled by a first-order or second-order polynomial, i.e.

$$V_{OUT,MOD} = F_{DET}(P_{IN}, T_0)[1 + (T - T_0)TC_1(P_{IN}) + (T - T_0)^2TC_2(P_{IN}) + O(T^3)]$$

The required temperature dependence of the estimator, to compensate for the detector temperature dependence can be approximated similarly:

$$\begin{aligned} P_{EST} &= F_{DET}^{-1}[V_{OUT}(T), T_0]\{1 + (T - T_0)S_1[V_{OUT}(T)] + \\ &\quad + (T - T_0)^2S_2[V_{OUT}(T)] + O(T^3)\} \\ &\approx F_{DET}^{-1}[V_{OUT}(T), T_0]\{1 + (T - T_0)S_1[V_{OUT}(T)]\} \end{aligned}$$

The last approximation results from the fact that a first-order temperature compensation is usually sufficiently accurate. The remainder of this section will therefore concentrate on first-order compensation. For second and higher-order compensation a similar approach can be followed.

Ideally, the temperature drift could be completely eliminated if the measurement system is calibrated at various temperatures and input power levels to determine the Temperature Sensitivity S_1 . In a practical application, however that is usually not possible due to the associated high costs. The alternative is to use the average temperature drift in the estimator, instead of the temperature sensitivity of each device individually. In this way it becomes possible to eliminate the systematic (reproducible) component of the temperature drift without the need for calibration at different temperatures during manufacturing. What remains is the random temperature drift, which differs from device to device. Figure 8 illustrates the idea. The graph at the left schematically represents the behavior of the drift error versus temperature at a certain input power level for a large number of devices.

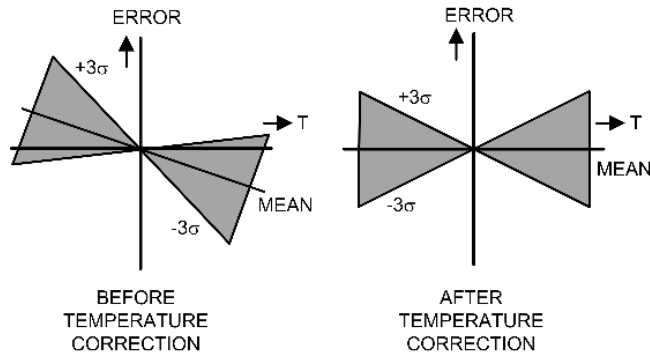

20173765

FIGURE 8. Elimination of the Systematic Component from the Temperature Drift

The mean drift error represents the reproducible - systematic - part of the error, while the mean ± 3 sigma limits represent the combined systematic plus random error component. Obviously the drift error must be zero at calibration temperature T_0 . If the systematic component of the drift error is included in the estimator, the total drift error becomes equal to only the random component, as illustrated in the graph at the right of Figure 8. A significant reduction of the temperature drift error can be achieved in this way only if:

- The systematic component is significantly larger than the random error component (otherwise the difference is negligible).
- The operating temperature is measured with sufficient accuracy.

It is essential for the effectiveness of the temperature compensation to assign the appropriate value to the temperature sensitivity S_1 . Two different approaches can be followed to determine this parameter:

- Determination of a single value to be used over the entire operating temperature range.
- Division of the operating temperature range in segments and use of separate values for each of the segments.

Also for the first method, the accuracy of the extracted temperature sensitivity increases when the number of measure-

ment temperatures increases. Linear regression to temperature can then be used to determine the two parameters of the linear model for the temperature drift error: the first order temperature sensitivity S_1 and the best-fit (room temperature) value for the power estimate at T_0 : $F_{DET}[V_{OUT}(T), T_0]$. Note that to achieve an overall - over all temperatures - minimum error, the room temperature drift error in the model can be non-zero at the calibration temperature (which is not in agreement with the strict definition).

The second method does not have this drawback but is more complex. In fact, segmentation of the temperature range is a form of higher-order temperature compensation using only a first-order model for the different segments: one for temperatures below 25°C, and one for temperatures above 25°C. The mean (or typical) temperature sensitivity is the value to be used for compensation of the systematic drift error component. Figure 9 shows the temperature drift error without and with temperature compensation using two segments. With compensation the systematic component is completely eliminated; the remaining random error component is centered around zero. Note that the random component is slightly larger at -40°C than at 85°C.

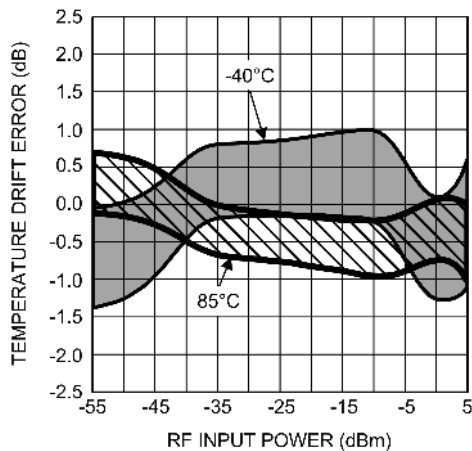

20173752

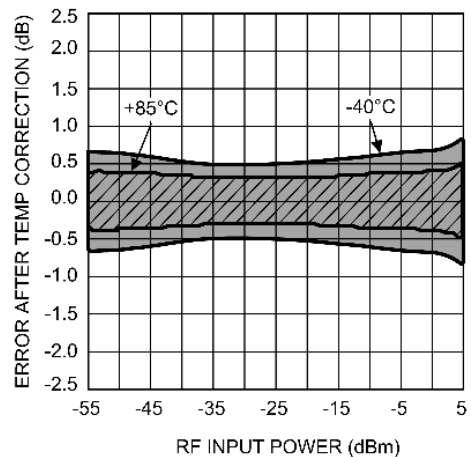

20173795

FIGURE 9. Temperature Drift Error without and with Temperature Compensation

In a practical power measurement system, temperature compensation is usually only applied to a small power range around the maximum power level for two reasons:

- The various communication standards require the highest accuracy in this range to limit interference.
- The temperature sensitivity itself is a function of the power level it becomes impractical to store a large number of different temperature sensitivity values for different power levels.

The table in the datasheet specifies the temperature sensitivity for the aforementioned two segments at an input power level of -10 dBm (near the top-end of the detector dynamic range). The typical value represents the mean which is to be used for calibration.

2.5 Differential Power Errors

Many third generation communication systems contain a power control loop through the base station and mobile unit that requests both to frequently update the transmit power level by a small amount (typically 1 dB). For such applications it is important that the actual change of the transmit power is sufficiently close to the requested power change.

The error metrics in the datasheet that describe the accuracy of the detector for a change in the input power are $E_{1\text{ dB}}$ (for a 1 dB change in the input power) and $E_{10\text{ dB}}$ (for a 10 dB step, or ten consecutive steps of 1 dB). Since it can be assumed that the temperature does not change during the power step

the differential error equals the difference of the drift error at the two involved power levels:

$$E_{1\text{ dB}}(P_{\text{IN}}, T) = E_{\text{DRIFT}}(P_{\text{IN}} + 1\text{ dB}, T) - E_{\text{DRIFT}}(P_{\text{IN}}, T)$$

$$E_{10\text{ dB}}(P_{\text{IN}}, T) = E_{\text{DRIFT}}(P_{\text{IN}} + 10\text{ dB}, T) - E_{\text{DRIFT}}(P_{\text{IN}}, T)$$

It should be noted that the step error increases significantly when one (or both) power levels in the above expression are outside the detector dynamic range. For $E_{10\text{ dB}}$ this occurs when P_{IN} is less than 10 dB below the maximum input power of the dynamic range, P_{MAX} .

3.0 DETECTOR INTERFACING

For optimal performance of the LMV221, it is important that all its pins are connected to the surrounding circuitry in the appropriate way. This section discusses guidelines and requirements for the electrical connection of each pin of the LMV221 to ensure proper operation of the device. Starting from a block diagram, the function of each pin is elaborated. Subsequently, the details of the electrical interfacing are separately discussed for each pin. Special attention will be paid to the output filtering options and the differences between single ended and differential interfacing with an ADC.

3.1 Block Diagram of the LMV221

The block diagram of the LMV221 is depicted in Figure 10.

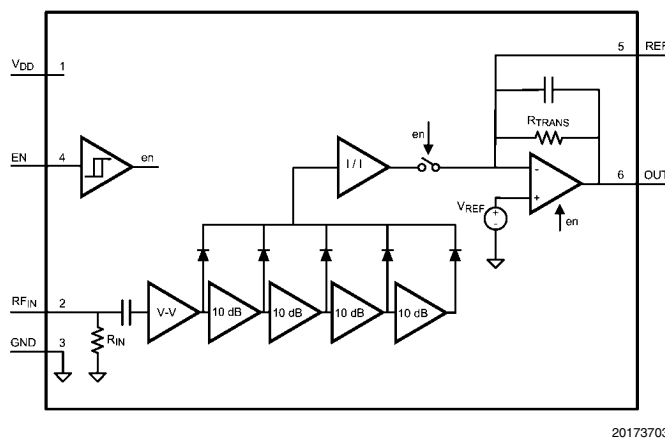

FIGURE 10. Block Diagram of the LMV221

The core of the LMV221 is a progressive compression LOG-detector consisting of four gain stages. Each of these saturating stages has a gain of approximately 10 dB and therefore realizes about 10 dB of the detector dynamic range. The five diode cells perform the actual detection and convert the RF signal to a DC current. This DC current is subsequently supplied to the transimpedance amplifier at the output, that converts it into an output voltage. In addition, the amplifier provides buffering of and applies filtering to the detector output signal. To prevent discharge of filtering capacitors between OUT and GND in shutdown, a switch is inserted at the amplifier input that opens in shutdown to realize a high impedance output of the device.

3.2 RF Input

RF parts typically use a characteristic impedance of 50Ω. To comply with this standard the LMV221 has an input impedance of 50Ω. Using a characteristic impedance other than 50Ω will cause a shift of the logarithmic intercept with

respect to the value given in the electrical characteristics table. This intercept shift can be calculated according to the following formula:

$$P_{\text{INT-SHIFT}} = 10 \text{ LOG} \left(\frac{2 R_{\text{SOURCE}}}{R_{\text{SOURCE}} + 50} \right)$$

The intercept will shift to higher power levels for $R_{\text{SOURCE}} > 50\Omega$, and will shift to lower power levels for $R_{\text{SOURCE}} < 50\Omega$.

3.3 Shutdown

To save power, the LMV221 can be brought into a low-power shutdown mode. The device is active for $EN = \text{HIGH}$ ($V_{\text{EN}} > 1.1\text{V}$) and in the low-power shutdown mode for $EN = \text{LOW}$ ($V_{\text{EN}} < 0.6\text{V}$). In this state the output of the LMV221 is switched to a high impedance mode. Using the shutdown

function, care must be taken not to exceed the absolute maximum ratings. Forcing a voltage to the enable input that is 400 mV higher than V_{DD} or 400 mV lower than GND will damage the device and further operations is not guaranteed. The absolute maximum ratings can also be exceeded when the enable EN is switched to HIGH (from shutdown to active mode) while the supply voltage is low (off). This should be prevented at all times. A possible solution to protect the part is to add a resistor of 100 k Ω in series with the enable input.

3.4 Output and Reference

This section describes the possible filtering techniques that can be applied to reduce ripple in the detector output voltage.

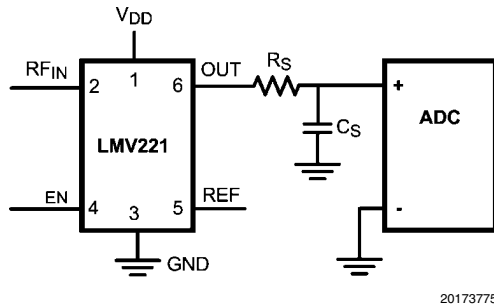

20173775

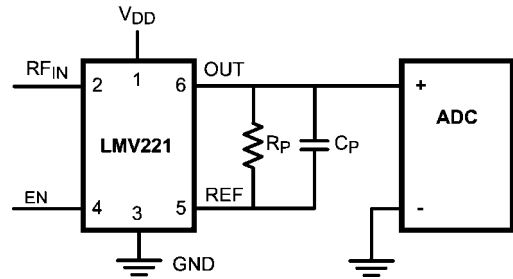

20173776

FIGURE 11. Low Pass Output Filter and Low Pass Feedback Filter

Depending on the system requirements one of these filtering techniques can be selected. The low pass output filter has the advantage that it preserves the output voltage when the LMV221 is brought into shutdown. This is elaborated in section 3.4.3. In the feedback filter, resistor R_p discharges capacitor C_p in shutdown and therefore changes the output voltage of the device.

A disadvantage of the low pass output filter is that the series resistor R_s limits the output drive capability. This may cause inaccuracies in the voltage read by an ADC when the ADC input impedance is not significantly larger than R_s . In that case, the current flowing through the ADC input induces an error voltage across filter resistor R_s . The low pass feedback filter doesn't have this disadvantage.

Note that adding an external resistor between OUT and REF reduces the transfer gain (LOG-slope and LOG-intercept) of the device. The internal feedback resistor sets the gain of the transimpedance amplifier.

The filtering of the low pass output filter is realized by resistor R_s and capacitor C_s . The -3 dB bandwidth of this filter can

then be calculated by: $f_{-3\text{dB}} = 1 / 2\pi R_s C_s$. The bandwidth of the low pass feedback filter is determined by external resistor R_p in parallel with the internal resistor R_{TRANS} , and external capacitor C_p in parallel with internal capacitor C_{TRANS} (see Figure 13). The -3 dB bandwidth of the feedback filter can be calculated by $f_{-3\text{dB}} = 1 / 2\pi (R_p / R_{\text{TRANS}}) (C_p + C_{\text{TRANS}})$. The bandwidth set by the internal resistor and capacitor (when no external components are connected between OUT and REF) equals $f_{-3\text{dB}} = 1 / 2\pi R_{\text{TRANS}} C_{\text{TRANS}} = 450\text{ kHz}$.

3.4.2 Interface to the ADC

The LMV221 can be connected to the ADC with a single ended or a differential topology. The single ended topology connects the output of the LMV221 to the input of the ADC and the reference pin is not connected. In a differential topology, both the output and the reference pins of the LMV221 are connected to the ADC. The topologies are depicted in Figure 12.

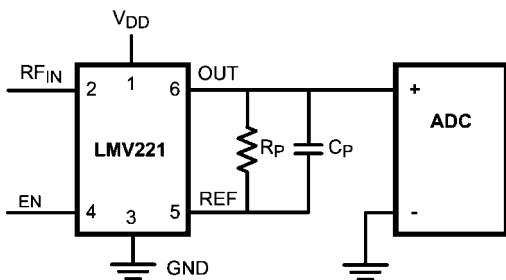

20173776

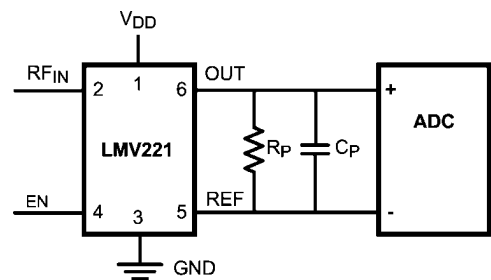

20173777

FIGURE 12. Single Ended and Differential Application

The differential topology has the advantage that it is compensated for temperature drift of the internal reference voltage. This can be explained by looking at the transimpedance amplifier of the LMV221 (Figure 13).

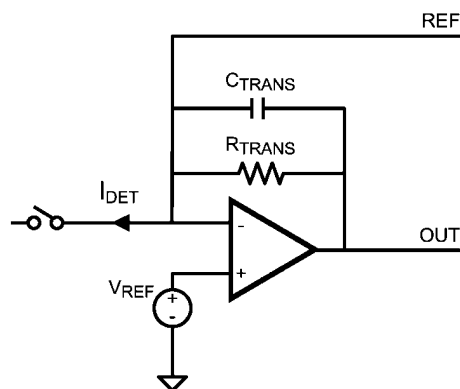

20173778

FIGURE 13. Output Stage of the LMV221

It can be seen that the output of the amplifier is set by the detection current I_{DET} multiplied by the resistor R_{TRANS} plus the reference voltage V_{REF} :

$$V_{OUT} = I_{DET} R_{TRANS} + V_{REF}$$

I_{DET} represents the detector current that is proportional to the RF input power. The equation shows that temperature variations in V_{REF} are also present in the output V_{OUT} . In case of a single ended topology the output is the only pin that is connected to the ADC. The ADC voltage for single ended is thus:

$$\text{Single ended: } V_{ADC} = I_{DET} R_{TRANS} + V_{REF}$$

A differential topology also connects the reference pin, which is the value of reference voltage V_{REF} . The ADC reads $V_{OUT} - V_{REF}$:

$$\text{Differential: } V_{ADC} = V_{OUT} - V_{REF} = I_{DET} R_{TRANS}$$

The resulting equation doesn't contain the reference voltage V_{REF} anymore. Temperature variations in this reference voltage are therefore not measured by the ADC.

3.4.3 Output Behavior in Shutdown

In order to save power, the LMV221 can be used in pulsed mode, such that it is active to perform the power measurement only during a fraction of the time. During the remaining time the device is in low-power shutdown. Applications using this approach usually require that the output value is available at all times, also when the LMV221 is in shutdown. The settling time in active mode, however, should not become excessively large. This can be realized by the combination of the LMV221 and a low pass output filter (see Figure 11, left side), as discussed below.

In active mode, the filter capacitor C_S is charged to the output voltage of the LMV221 — which in this mode has a low output

impedance to enable fast settling. During shutdown-mode, the capacitor should preserve this voltage. Discharge of C_S through any current path should therefore be avoided in shutdown. The output impedance of the LMV221 becomes high in shutdown, such that the discharge current cannot flow from the capacitor top plate, through R_S , and the LMV221's OUT pin to GND. This is realized by the internal shutdown mechanism of the output amplifier and by the switch depicted in Figure 13. Additionally, it should be ensured that the ADC input impedance is high as well, to prevent a possible discharge path through the ADC.

4.0 BOARD LAYOUT RECOMMENDATIONS

As with any other RF device, careful attention must be paid to the board layout. If the board layout isn't properly designed, unwanted signals can easily be detected or interference will be picked up. This section gives guidelines for proper board layout for the LMV221.

Electrical signals (voltages / currents) need a finite time to travel through a trace or transmission line. RF voltage levels at the generator side and at the detector side can therefore be different. This is not only true for the RF strip line, but for all traces on the PCB. Signals at different locations or traces on the PCB will be in a different phase of the RF frequency cycle. Phase differences in, e.g. the voltage across neighboring lines, may result in crosstalk between lines, due to parasitic capacitive or inductive coupling. This crosstalk is further enhanced by the fact that all traces on the PCB are susceptible to resonance. The resonance frequency depends on the trace geometry. Traces are particularly sensitive to interference when the length of the trace corresponds to a quarter of the wavelength of the interfering signal or a multiple thereof.

4.1 Supply Lines

Since the PSRR of the LMV221 is finite, variations of the supply can result in some variation at the output. This can be caused among others by RF injection from other parts of the circuitry or the on/off switching of the PA.

4.1.1 Positive Supply (V_{DD})

In order to minimize the injection of RF interference into the LMV221 through the supply lines, the phase difference between the PCB traces connecting to V_{DD} and GND should be minimized. A suitable way to achieve this is to short both connections for RF. This can be done by placing a small decoupling capacitor between the V_{DD} and GND. It should be placed as close as possible to the V_{DD} and GND pins of the LMV221. Due to the presence of the RF input, the best possible position would be to extend the GND plane connecting to the DAP slightly beyond the short edge of the package, such that the capacitor can be placed directly to the V_{DD} pin (Figure 14). Be aware that the resonance frequency of the capacitor itself should be above the highest RF frequency used in the application, since the capacitor acts as an inductor above its resonance frequency.

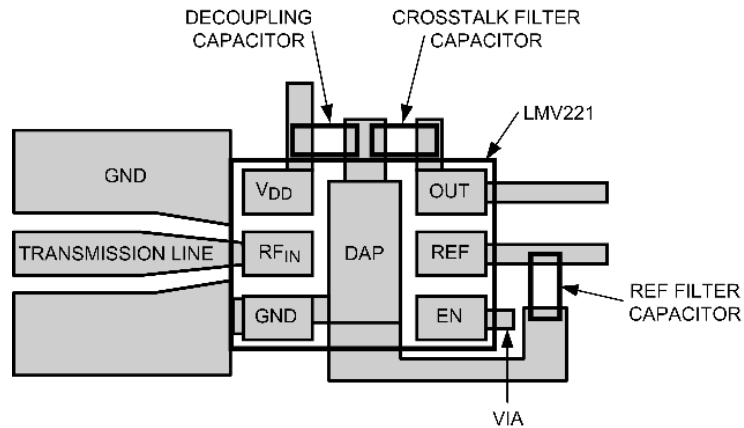

20173701

FIGURE 14. Recommended Board Layout

Low frequency supply voltage variations due to PA switching might result in a ripple at the output voltage. The LMV221 has a Power Supply Rejection Ratio of 60 dB for low frequencies.

4.1.2 Ground (GND)

The LMV221 needs a ground plane free of noise and other disturbing signals. It is important to separate the RF ground return path from the other grounds. This is due to the fact that the RF input handles large voltage swings. A power level of 0 dBm will cause a voltage swing larger than $0.6 V_{PP}$, over the internal 50Ω input resistor. This will result in a significant RF return current toward the source. It is therefore recommended that the RF ground return path not be used for other circuits in the design. The RF path should be routed directly back to the source without loops.

4.2 RF Input Interface

The LMV221 is designed to be used in RF applications, having a characteristic impedance of 50Ω . To achieve this impedance, the input of the LMV221 needs to be connected via a 50Ω transmission line. Transmission lines can be easily created on PCBs using microstrip or (grounded) coplanar waveguide (GCPW) configurations. This section will discuss both configurations in a general way. For more details about designing microstrip or GCPW transmission lines, a microwave designer handbook is recommended.

4.2.1 Microstrip Configuration

One way to create a transmission line is to use a microstrip configuration. A cross section of the configuration is shown in Figure 15, assuming a two layer PCB.

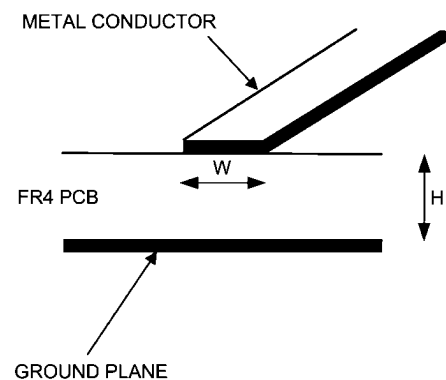

20173780

FIGURE 15. Microstrip Configuration

A conductor (trace) is placed on the topside of a PCB. The bottom side of the PCB has a fully copper ground plane. The characteristic impedance of the microstrip transmission line is a function of the width W , height H , and the dielectric constant ϵ_r .

Characteristics such as height and the dielectric constant of the board have significant impact on transmission line dimensions. A 50Ω transmission line may result in impractically wide traces. A typical 1.6 mm thick FR4 board results in a trace width of 2.9 mm, for instance. This is impractical for the LMV221, since the pad width of the LLP-6 package is 0.25 mm. The transmission line has to be tapered from 2.9 mm to 0.25 mm. Significant reflections and resonances in the frequency transfer function of the board may occur due to this tapering.

4.2.2 GCPW Configuration

A transmission line in a (grounded) coplanar waveguide (GCPW) configuration will give more flexibility in terms of trace width. The GCPW configuration is constructed with a conductor surrounded by ground at a certain distance, S , on the top side. Figure 16 shows a cross section of this configuration. The bottom side of the PCB is a ground plane. The ground planes on both sides of the PCB should be firmly connected to each other by multiple vias. The characteristic impedance of the transmission line is mainly determined by

the width W and the distance S . In order to minimize reflections, the width W of the center trace should match the size of the package pad. The required value for the characteristic impedance can subsequently be realized by selection of the proper gap width S .

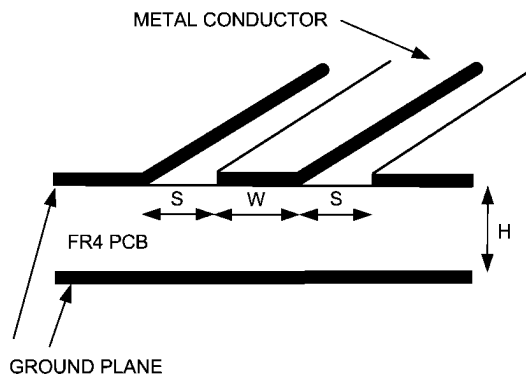

20173781

FIGURE 16. GCPW Configuration

4.3 Reference REF

The Reference pin can be used to compensate for temperature drift of the internal reference voltage as described in Section 3.4.2. The REF pin is directly connected to the inverting input of the transimpedance amplifier. Thus, RF signals and other spurious signals couple directly through to the output. Introduction of RF signals can be prevented by connecting a small capacitor between the REF pin and ground. The capacitor should be placed close to the REF pin as depicted in Figure 14.

4.4 Output OUT

The OUT pin is sensitive to crosstalk from the RF input, especially at high power levels. The ESD diode between the output and V_{DD} may rectify the crosstalk, but may add an unwanted inaccurate DC component to the output voltage.

The board layout should minimize crosstalk between the detectors input RF_{IN} and the detectors output. Using an additional capacitor connected between the output and the positive supply voltage (V_{DD} pin) or GND can prevent this. For optimal performance this capacitor should be placed as close as possible to the OUT pin of the LMV221; e.g. extend the DAP GND plane and place the capacitor next to the OUT pin.

Physical Dimensions inches (millimeters) unless otherwise noted

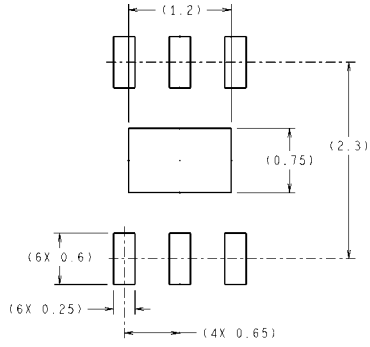

RECOMMENDED LAND PATTERN

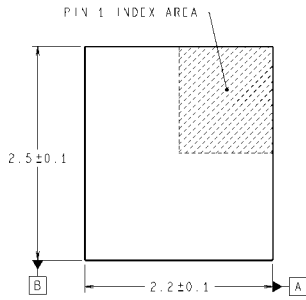

DIMENSIONS ARE IN MILLIMETERS
DIMENSIONS IN () FOR REFERENCE ONLY

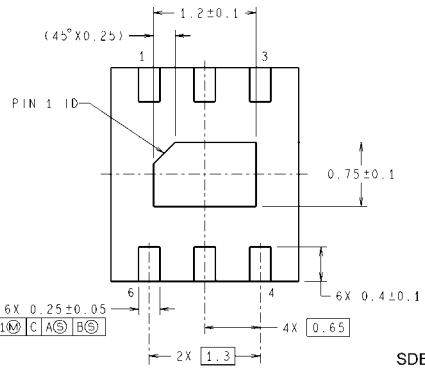
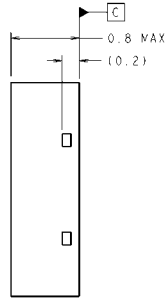
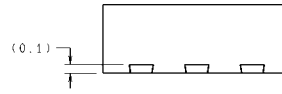

6-Pin LLP
NS Package Number SDB06A

SDB06A (Rev A)

Notes

Notes

For more National Semiconductor product information and proven design tools, visit the following Web sites at:

Products		Design Support	
Amplifiers	www.national.com/amplifiers	WEBENCH	www.national.com/webench
Audio	www.national.com/audio	Analog University	www.national.com/AU
Clock Conditioners	www.national.com/timing	App Notes	www.national.com/appnotes
Data Converters	www.national.com/adc	Distributors	www.national.com/contacts
Displays	www.national.com/displays	Green Compliance	www.national.com/quality/green
Ethernet	www.national.com/ethernet	Packaging	www.national.com/packaging
Interface	www.national.com/interface	Quality and Reliability	www.national.com/quality
LVDS	www.national.com/lvds	Reference Designs	www.national.com/refdesigns
Power Management	www.national.com/power	Feedback	www.national.com/feedback
Switching Regulators	www.national.com/switchers		
LDOs	www.national.com/ldo		
LED Lighting	www.national.com/led		
PowerWise	www.national.com/powerwise		
Serial Digital Interface (SDI)	www.national.com/sdi		
Temperature Sensors	www.national.com/tempsensors		
Wireless (PLL/VCO)	www.national.com/wireless		

THE CONTENTS OF THIS DOCUMENT ARE PROVIDED IN CONNECTION WITH NATIONAL SEMICONDUCTOR CORPORATION ("NATIONAL") PRODUCTS. NATIONAL MAKES NO REPRESENTATIONS OR WARRANTIES WITH RESPECT TO THE ACCURACY OR COMPLETENESS OF THE CONTENTS OF THIS PUBLICATION AND RESERVES THE RIGHT TO MAKE CHANGES TO SPECIFICATIONS AND PRODUCT DESCRIPTIONS AT ANY TIME WITHOUT NOTICE. NO LICENSE, WHETHER EXPRESS, IMPLIED, ARISING BY ESTOPPEL OR OTHERWISE, TO ANY INTELLECTUAL PROPERTY RIGHTS IS GRANTED BY THIS DOCUMENT.

TESTING AND OTHER QUALITY CONTROLS ARE USED TO THE EXTENT NATIONAL DEEMS NECESSARY TO SUPPORT NATIONAL'S PRODUCT WARRANTY. EXCEPT WHERE MANDATED BY GOVERNMENT REQUIREMENTS, TESTING OF ALL PARAMETERS OF EACH PRODUCT IS NOT NECESSARILY PERFORMED. NATIONAL ASSUMES NO LIABILITY FOR APPLICATIONS ASSISTANCE OR BUYER PRODUCT DESIGN. BUYERS ARE RESPONSIBLE FOR THEIR PRODUCTS AND APPLICATIONS USING NATIONAL COMPONENTS. PRIOR TO USING OR DISTRIBUTING ANY PRODUCTS THAT INCLUDE NATIONAL COMPONENTS, BUYERS SHOULD PROVIDE ADEQUATE DESIGN, TESTING AND OPERATING SAFEGUARDS.

EXCEPT AS PROVIDED IN NATIONAL'S TERMS AND CONDITIONS OF SALE FOR SUCH PRODUCTS, NATIONAL ASSUMES NO LIABILITY WHATSOEVER, AND NATIONAL DISCLAIMS ANY EXPRESS OR IMPLIED WARRANTY RELATING TO THE SALE AND/OR USE OF NATIONAL PRODUCTS INCLUDING LIABILITY OR WARRANTIES RELATING TO FITNESS FOR A PARTICULAR PURPOSE, MERCHANTABILITY, OR INFRINGEMENT OF ANY PATENT, COPYRIGHT OR OTHER INTELLECTUAL PROPERTY RIGHT.

LIFE SUPPORT POLICY

NATIONAL'S PRODUCTS ARE NOT AUTHORIZED FOR USE AS CRITICAL COMPONENTS IN LIFE SUPPORT DEVICES OR SYSTEMS WITHOUT THE EXPRESS PRIOR WRITTEN APPROVAL OF THE CHIEF EXECUTIVE OFFICER AND GENERAL COUNSEL OF NATIONAL SEMICONDUCTOR CORPORATION. As used herein:

Life support devices or systems are devices which (a) are intended for surgical implant into the body, or (b) support or sustain life and whose failure to perform when properly used in accordance with instructions for use provided in the labeling can be reasonably expected to result in a significant injury to the user. A critical component is any component in a life support device or system whose failure to perform can be reasonably expected to cause the failure of the life support device or system or to affect its safety or effectiveness.

National Semiconductor and the National Semiconductor logo are registered trademarks of National Semiconductor Corporation. All other brand or product names may be trademarks or registered trademarks of their respective holders.

Copyright© 2008 National Semiconductor Corporation

For the most current product information visit us at www.national.com



**National Semiconductor
Americas Technical
Support Center**
Email:
new.feedback@nsc.com
Tel: 1-800-272-9959

**National Semiconductor Europe
Technical Support Center**
Email: europe.support@nsc.com
German Tel: +49 (0) 180 5010 771
English Tel: +44 (0) 870 850 4288

**National Semiconductor Asia
Pacific Technical Support Center**
Email: ap.support@nsc.com

**National Semiconductor Japan
Technical Support Center**
Email: jpn.feedback@nsc.com