

XS4P30MA230K

Inductive proximity sensors XS, inductive sensor XS4 M30, L70mm, PPS, Sn15mm, 24...240VAC/DC, 1/2"



Main

Range of Product	Telemecanique Inductive proximity sensors XS
Series name	General purpose
Sensor Type	Inductive proximity sensor
Sensor name	XS4
Sensor design	Cylindrical M30
Size	70 mm
Body type	Fixed
Detector flush mounting acceptance	Non flush mountable
Material	Plastic
Type of output signal	Discrete
Wiring Technique	2-wire
[Sn] nominal sensing distance	0.59 in (15 mm)
Discrete output function	1 NO
Output circuit type	AC/DC
Electrical connection	Male connector 1/2"20 UNF, 3 pins
[Us] rated supply voltage	24...240 V AC/DC 50/60 Hz
Switching capacity in mA	5...200 mA DC 5...300 mA AC
IP degree of protection	IP67 conforming to IEC 60529

Complementary

Thread type	M30 x 1.5
Detection face	Frontal
Front material	PPS
Enclosure Material	PPS
Operating zone	0.00...0.47 in (0...12 mm)
Differential travel	1...15% of Sr
Status LED	Output state 1 LED yellow)
Supply voltage limits	20...264 V AC/DC
Maximum residual current	0.6 mA open state
Switching frequency	<= 1000 Hz DC <= 25 Hz AC
Maximum voltage drop	<5.5 V closed)
Maximum delay first up	40 ms
Maximum delay response	0.2 ms
Maximum delay recovery	0.4 ms
Marking	CE
Threaded length	2.05 in (52 mm)
Height	1.18 in (30 mm)
Length	2.76 in (70 mm)
Net Weight	0.18 lb(US) (0.08 kg)

Environment

Product Certifications	CSA UL Ecolab CCC
Ambient air temperature for operation	-13...158 °F (-25...70 °C)
Ambient Air Temperature for Storage	-40...185 °F (-40...85 °C)
Vibration resistance	25 gn +/- 2 mm 10...55 Hz)IEC 60068-2-6
Shock resistance	50 gn 11 ms IEC 60068-2-27

Ordering and shipping details

Category	22486 - SENSORS, PROXIMITY
Discount Schedule	DS2
GTIN	3389110919578
Nbr. of units in pkg.	1
Package weight(Lbs)	2.75 oz (78 g)
Returnability	No
Country of origin	FR

Packing Units

Unit Type of Package 1	PCE
Package 1 Height	1.57 in (4 cm)
Package 1 width	3.58 in (9.1 cm)
Package 1 Length	4.41 in (11.2 cm)
Unit Type of Package 2	S01
Number of Units in Package 2	22
Package 2 Weight	4.11 lb(US) (1.865 kg)
Package 2 Height	5.91 in (15 cm)
Package 2 width	5.91 in (15 cm)
Package 2 Length	15.75 in (40 cm)
Package 3 Height	5.91 in (15 cm)

Offer Sustainability

Sustainable offer status	Green Premium product
California proposition 65	WARNING: This product can expose you to chemicals including: Diisononyl phthalate (DINP), which is known to the State of California to cause cancer, and Di-isodecyl phthalate (DIDP), which is known to the State of California to cause birth defects or other reproductive harm. For more information go to www.P65Warnings.ca.gov
REACH Regulation	 REACH Declaration
EU RoHS Directive	Pro-active compliance (Product out of EU RoHS legal scope)  EU RoHS Declaration
Mercury free	Yes
RoHS exemption information	 Yes
Environmental Disclosure	 Product Environmental Profile
Circularity Profile	 End Of Life Information

Contractual warranty

Warranty	18 months
----------	-----------

Dimensions

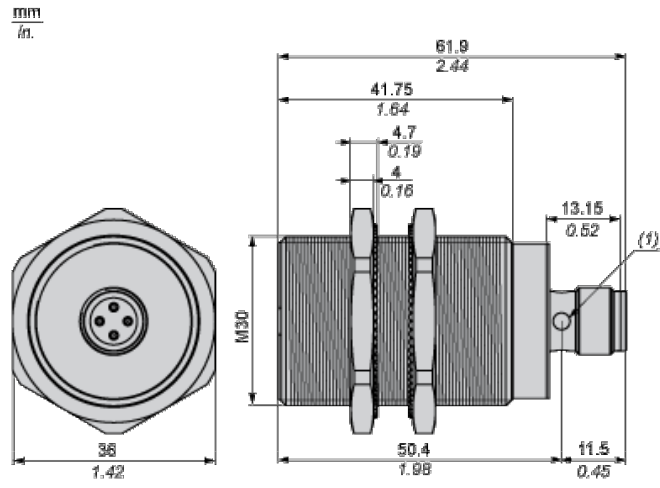

(1) LED

Minimum Mounting Distances

Side by side

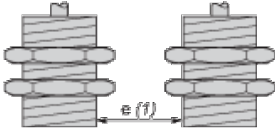

e (1) 60 mm/2.36 in.

≥

Face to face



e (2) 180 mm/7.09 in.

≥

Facing a metal object

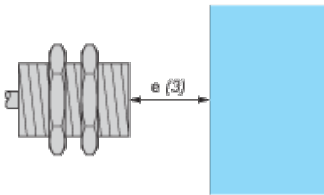

e (3) 45 mm/1.77 in.

≥

Mounted in a metal support

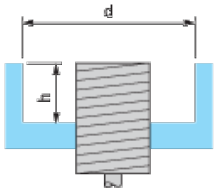

d ≥ 90 mm/3.54 in.

h ≥ 30 mm/1.18 in.

Wiring Schemes

1/2"-20UNF

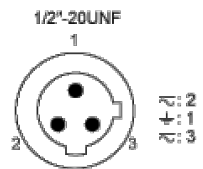

- 1 : Grounding
- 2 : AC
- 3 : AC

NO output

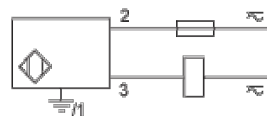

Performance Curves

Standard Steel Target : 45x45x1 mm

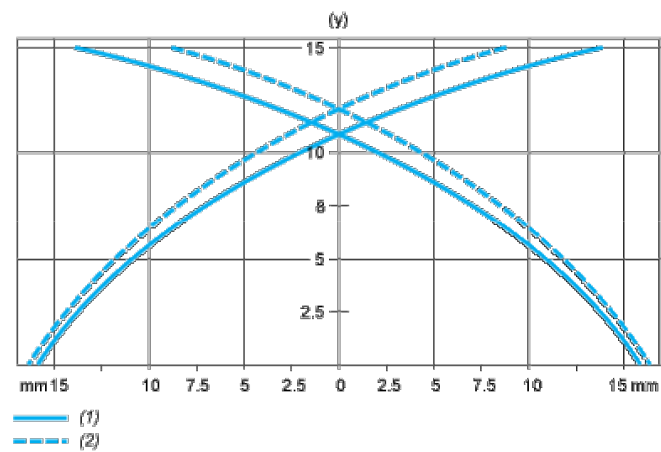

- (1) Pick-up points
- (2) Drop-out points (object approaching from the side)
- (y) Sensing distance in mm