

Illuminance click™

1. Introduction

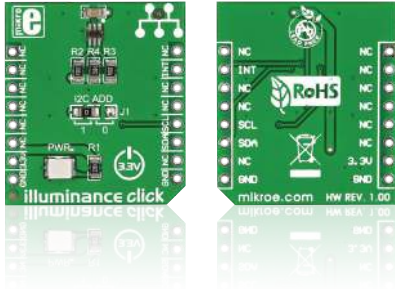

Illuminance click™ is a light sensor suited for detecting ambient lighting (compared to conventional light sensors that are overly sensitive to infrared). It carries **TSL2561**, a **light-to-digital converter**. Illuminance click™ transforms light received through two photodiodes into a digital signal, by way of two ADCs. It communicates with the target board through **mikroBUS™** I²C lines: SCL (clock) and SDA (data). It uses a 3.3V power supply only.

2. Soldering the headers

Before using your click™ board, make sure to solder 1x8 male headers to both left and right side of the board. Two 1x8 male headers are included with the board in the package.

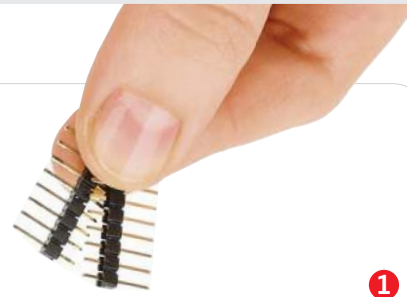

1

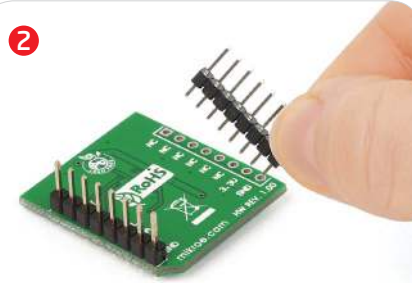

Turn the board upside down so that the bottom side is facing you upwards. Place shorter pins of the header into the appropriate soldering pads.

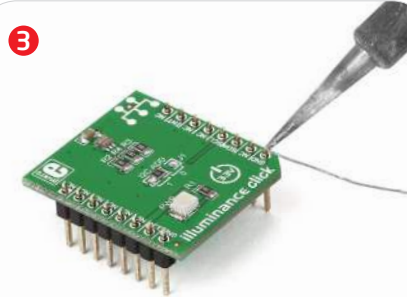

Turn the board upward again. Make sure to align the headers so that they are perpendicular to the board, then solder the pins carefully.

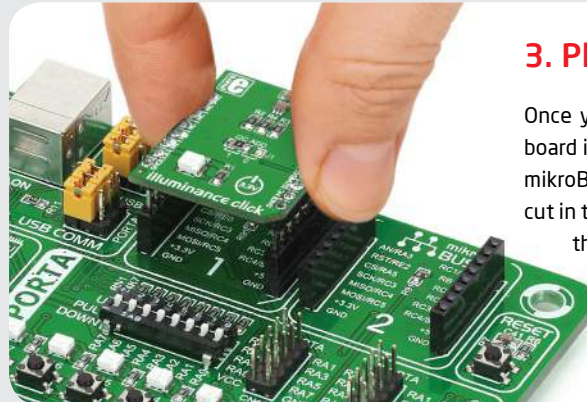

3. Plugging the board in

Once you have soldered the headers your board is ready to be placed into the desired mikroBUS™ socket. Make sure to align the cut in the lower-right part of the board with the markings on the silkscreen at the mikroBUS™ socket. If all the pins are aligned correctly, push the board all the way into the socket.

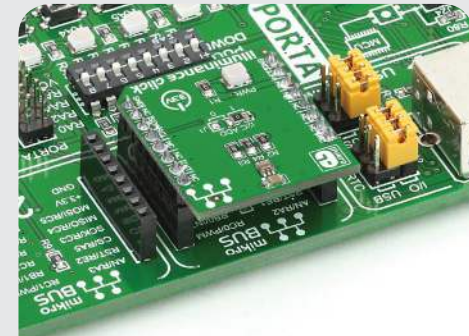

4. Essential features

The TSL2561 sensor on Illuminance click™ is designed to mimic the way humans perceive light. Conventional light sensors are too sensitive to infrared light to be suitable for measuring ambient lighting. The sensor on Illuminance click™ has two photodiodes. One is sensitive to the full-spectrum of light, the other to infrared light only. The visible-spectrum of light can then be deduced by using a formula. Applications include brightness adjustment for LCD and OLED displays, based upon ambient lighting conditions.

click™
BOARD
www.mikroe.com

Illuminance click™ manual
ver. 1.00



0 100000 027288

5. Illuminance click™ board schematic

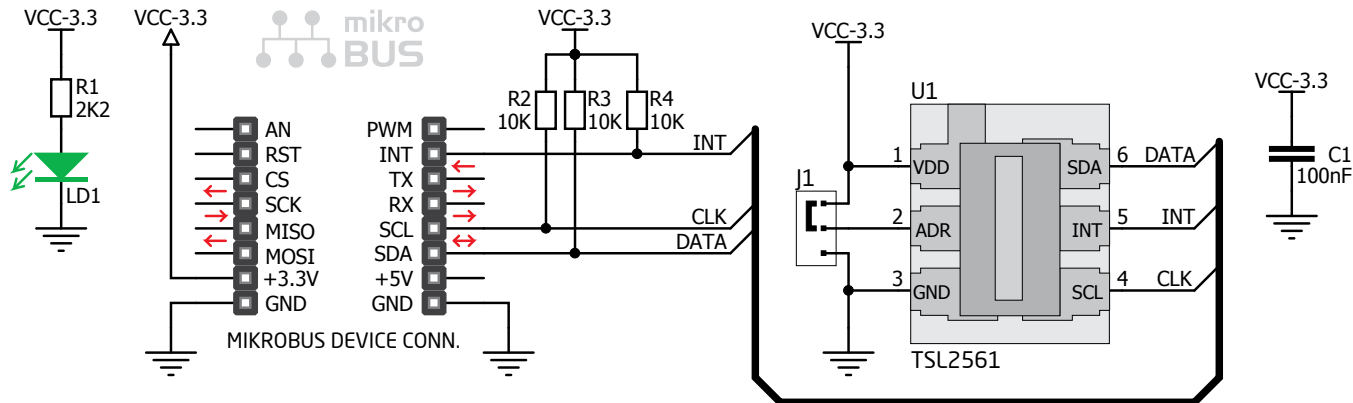

6. I²C Address selection



The J1 jumper on Illuminance click™ allows you to switch between three available I²C addresses. To select an address, switch the jumper between logic 1 (default) and logic 0 positions, or unsolder it completely.

7. Code examples

Once you have done all the necessary preparations, it's time to get your click™ board up and running. We have provided examples for mikroC™, mikroBasic™ and mikroPascal™ compilers on our **Libstock** website. Just download them and you are ready to start.



8. Support

MikroElektronika offers **free tech support** (www.mikroe.com/support) until the end of the product's lifetime, so if something goes wrong, we're ready and willing to help!