

HCPL-817

Phototransistor Optocoupler High-Density Mounting Type

Description

The Broadcom® HCPL-817 contains a light-emitting diode optically coupled to a phototransistor. It is packaged in a 4-pin DIP package and available in wide-lead spacing option and lead bend SMD option. Input-output isolation voltage is 5000 V_{rms} . Response time, t_r , is typically 4 μs and minimum CTR is 50% at input current of 5 mA.

Schematic

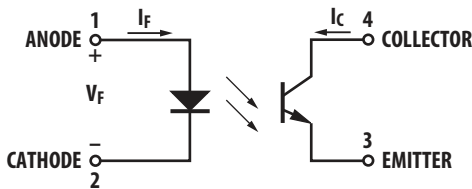

Functional Diagram

PIN NO. AND INTERNAL CONNECTION DIAGRAM

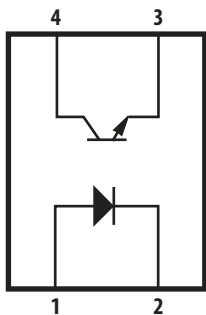

- 1. ANODE 3. EMITTER
- 2. CATHODE 4. COLLECTOR

Features

- Current Transfer Ratio (CTR: min. 50% at $I_F = 5 \text{ mA}$, $V_{CE} = 5V$)
- High input-output isolation voltage ($V_{iso} = 5000 V_{rms}$)
- Response time (t_r : typ., 4 μs at $V_{CE} = 2V$, $I_C = 2 \text{ mA}$, $R_L = 100\Omega$)
- Compact dual-inline package
- UL approved
- CSA approved
- IEC/EN/DIN EN 60747-5-5 approved
- Options available:
 - Leads with 0.4-in. (10.16-mm) spacing (W00)
 - Leads bends for surface mounting (300)
 - Tape and reel for SMD (500)
 - IEC/EN/DIN EN 60747-5-5 approvals (060)

Applications

- Signal transmission between circuits of different potentials and impedances
- I/O interfaces for computers
- Feedback circuit in power supply

CAUTION! It is advised that normal static precautions be taken in handling and assembly of this component to prevent damage and/or degradation that may be induced by ESD. The components featured in this data sheet are not to be used in military or aerospace applications or environments. The components are not AECQ100 qualified and are not recommended for automotive applications.

Ordering Information

HCPL-817-xxxx is UL Recognized with 5000 V_{rms} for 1 minute per UL1577 and is approved under CSA Component Acceptance Notice #5, File CA 88324.

Part Number	RoHS Compliant Option						Package	Surface Mount	Gull Wing	Tape and Reel	IEC/EN/DIN EN 60747-5-5	Quantity
	Rank '0' 50% <CTR< 600%	Rank 'A' 80% <CTR< 160%	Rank 'B' 130% <CTR< 260%	Rank 'C' 200% <CTR< 400%	Rank 'D' 300% <CTR< 600%	Rank 'L' 50% <CTR< 100%						
HCPL-817	-000E	-00AE	-00BE	-00CE	-00DE	-00LE	300-mil DIP-4					100 pieces per tube
	-300E	-30AE	-30BE	-30CE	-30DE	-30LE		X	X			100 pieces per tube
	-500E	-50AE	-50BE	-50CE	-50DE	-50LE		X	X	X		1000 pieces per reel
	-060E	-06AE	-06BE	-06CE	-06DE	-06LE					X	100 pieces per tube
	-360E	-36AE	-36BE	-36CE	-36DE	-36LE		X	X		X	100 pieces per tube
	-560E	-56AE	-56BE	-56CE	-56DE	-56LE		X	X	X	X	1000 pieces per reel
	-W00E	-W0AE	-W0BE	-W0CE	-W0DE	-W0LE	400-mil DIP-4					100 pieces per tube
	-W60E	-W6AE	-W6BE	-W6CE	-W6DE	-W6LE					X	100 pieces per tube

To order, choose a part number from the part number column and combine with the desired option from the option column to form an order entry.

Example 1:

HCPL-817-360E to order product of 300-mil DIP-4 DC Gull Wing Surface Mount package in Tube packaging with 50% < CTR < 600%, IEC/EN/DIN EN 60747-5-5 Safety Approval and RoHS compliant.

Example 2:

HCPL-817-50BE to order product of 300-mil DIP-4 DC Gull Wing Surface Mount package in Tape and Reel packaging with 130% < CTR < 260% and RoHS compliant.

Option data sheets are available. Contact your Broadcom sales representative or authorized distributor for information.

Package Outline Drawings

HCPL-817-000E

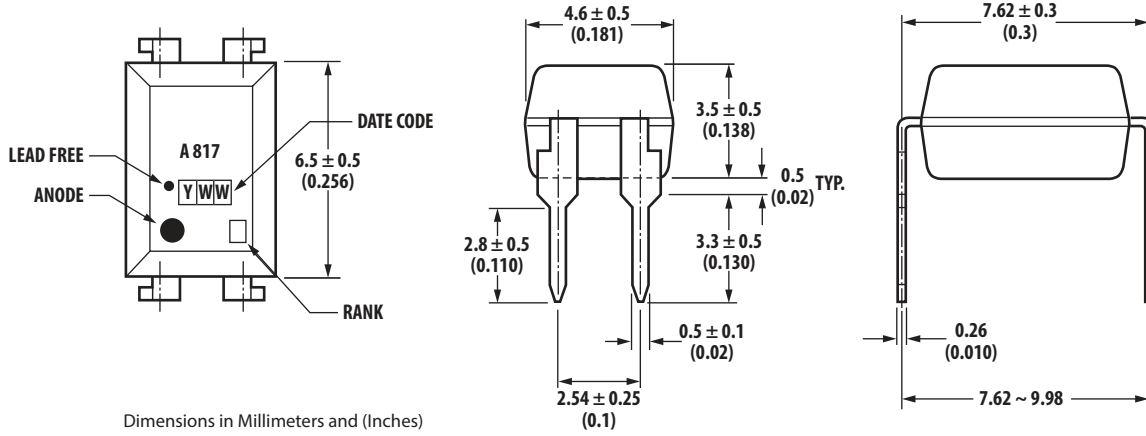

Dimensions in Millimeters and (Inches)

HCPL-817-060E

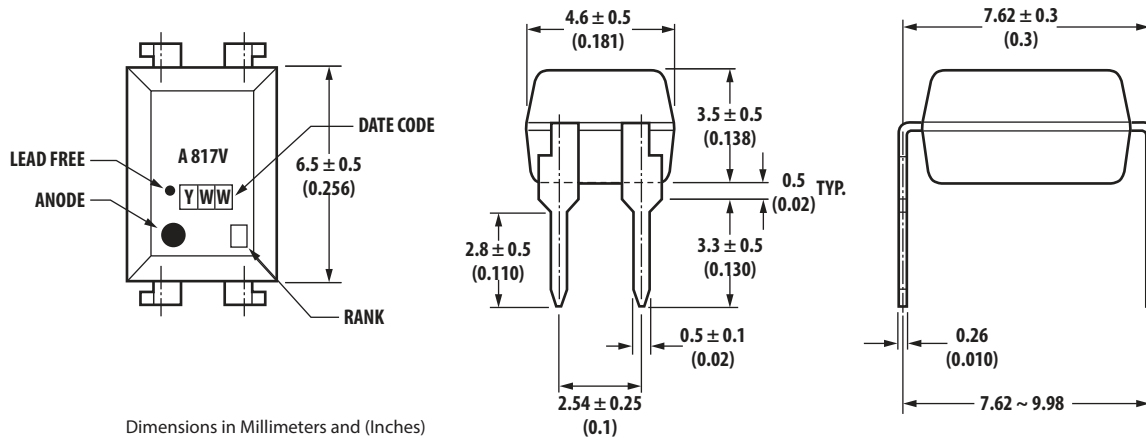

Dimensions in Millimeters and (Inches)

HCPL-817-W00E

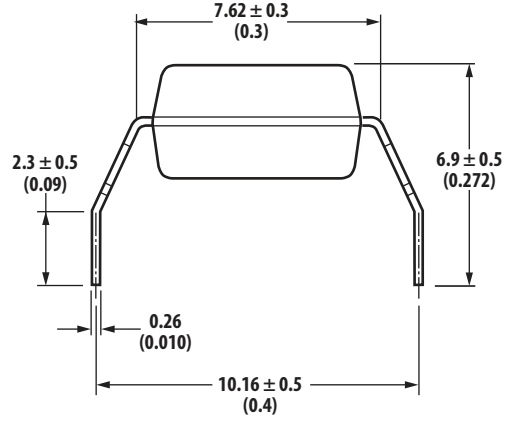
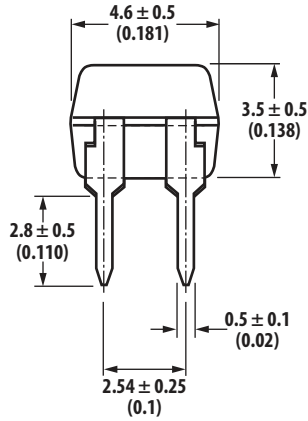
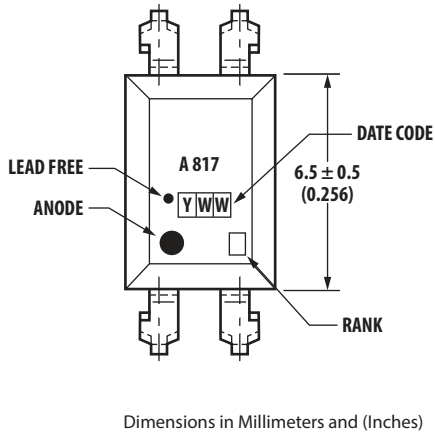

HCPL-817-300E

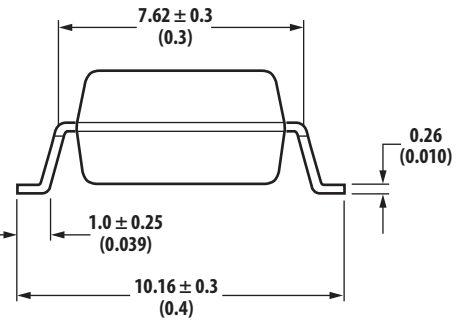
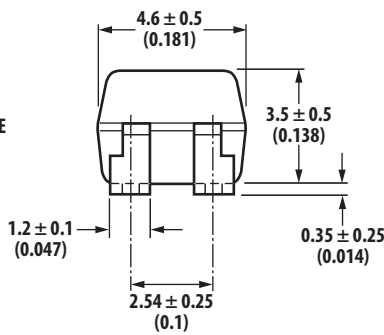
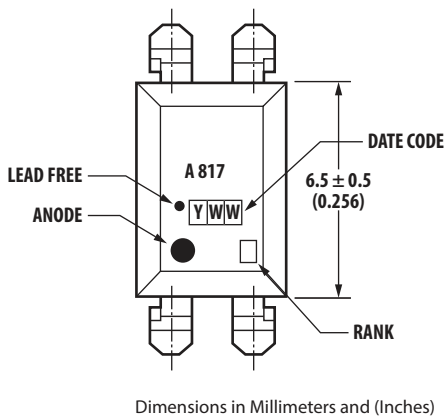

Solder Reflow Temperature Profile

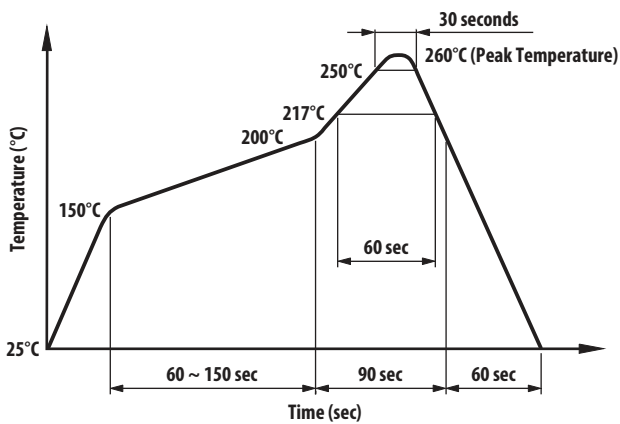

1. One-time soldering reflow is recommended within the condition of temperature and time profile shown.
2. When using another soldering method such as infrared ray lamp, the temperature may rise partially in the mold of the device. Keep the temperature on the package of the device within the first (1) condition.

NOTE: Non-halide flux should be used.

Absolute Maximum Ratings ($T_A = 25^\circ\text{C}$)

Parameter	Values
Storage Temperature, T_S	-55°C to $+125^\circ\text{C}$
Operating Temperature, T_A	-30°C to $+100^\circ\text{C}$
Lead Solder Temperature, max. (1.6 mm below seating plane)	260°C for 10s
Average Forward Current, I_F	50 mA
Reverse Input Voltage, V_R	6V
Input Power Dissipation, P_I	70 mW
Collector Current, I_C	50 mA
Collector-Emitter Voltage, V_{CEO}	70V
Emitter-Collector Voltage, V_{ECO}	6V
Collector Power Dissipation	150 mW
Total Power Dissipation	200 mW
Isolation Voltage, V_{iso} (AC for 1 minute, RH = 40 ~ 60%)	5000 V_{rms}

Electrical Specifications ($T_A = 25^\circ\text{C}$)

Parameter	Symbol	Min.	Typ.	Max.	Units	Test Conditions
Forward Voltage	V_F	—	1.2	1.4	V	$I_F = 20$ mA
Reverse Current	I_R	—	—	10	μA	$V_R = 4$ V
Terminal Capacitance	C_t	—	30	250	pF	$V = 0$, $f = 1$ kHz
Collector Dark Current	I_{CEO}	—	—	100	nA	$V_{CE} = 20$ V
Collector-Emitter Breakdown Voltage	BV_{CEO}	70	—	—	V	$I_C = 0.1$ mA
Emitter-Collector Breakdown Voltage	BV_{ECO}	6	—	—	V	$I_E = 10$ μA
Collector Current	I_C	2.5	—	30	mA	$I_F = 5$ mA, $V_{CE} = 5$ V, $R_{BE} = \infty$
Current Transfer Ratio ^a	CTR	50	—	600	%	
Collector-Emitter Saturation Voltage	$V_{CE(sat)}$	—	0.1	0.2	V	$I_F = 20$ mA, $I_C = 1$ mA
Response Time (Rise)	t_r	—	4	18	μs	$V_{CE} = 2$ V, $I_C = 2$ mA, $R_L = 100\Omega$
Response Time (Fall)	t_f	—	3	18	μs	
Cut-off Frequency	f_c	—	80	—	kHz	$V_{CC} = 5$ V, $I_C = 2$ mA, $R_L = 100\Omega$, -3 dB
Isolation Resistance	R_{iso}	5×10^{10}	1×10^{11}	—	Ω	DC 500V, 40 ~ 60% RH
Floating Capacitance	C_f	—	0.6	1.0	pF	$V = 0$, $f = 1$ MHz

a. $CTR = (I_C / I_F) \times 100\%$.

Figure 1: Forward Current vs. Temperature

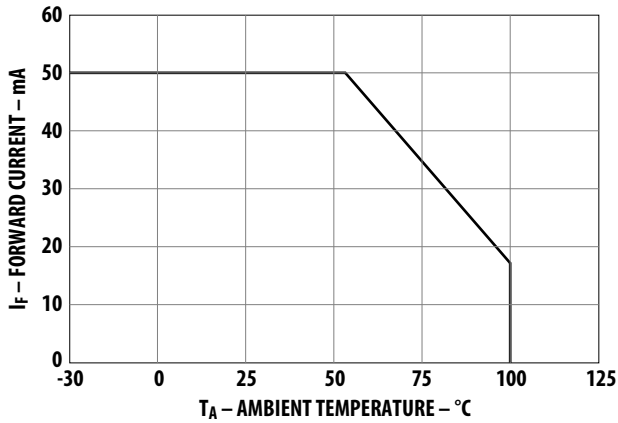

Figure 2: Collector Power Dissipation vs. Temperature

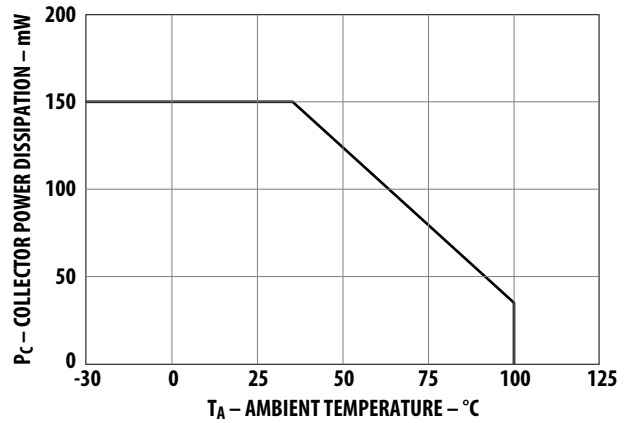

Figure 3: Collector-Emitter Saturation Voltage vs. Forward Current

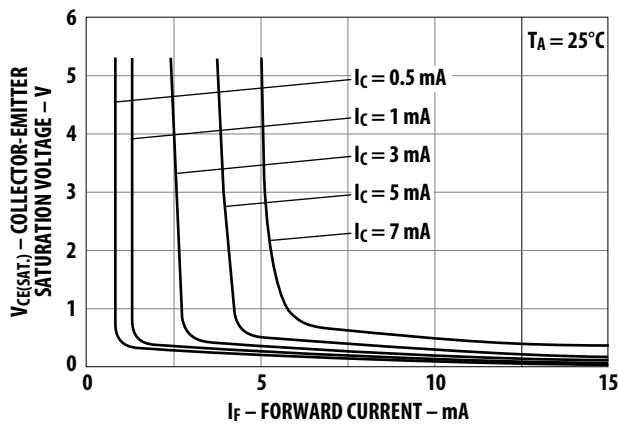

Figure 4: Forward Current vs. Forward Voltage

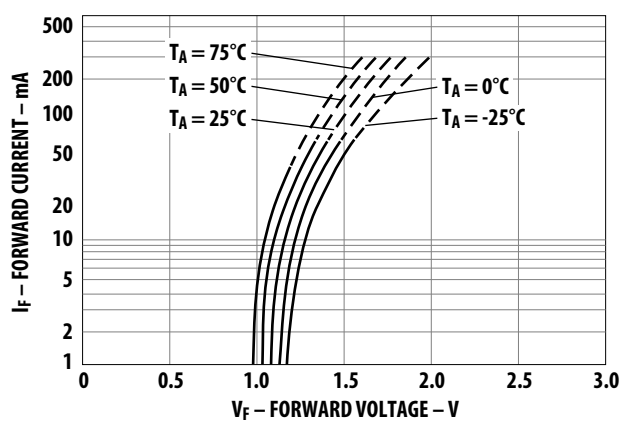

Figure 5: Current Transfer Ratio vs. Forward Current

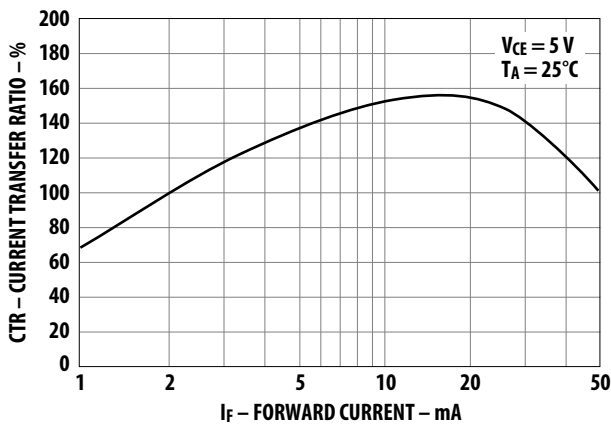

Figure 6: Collector Current vs. Collector-Emitter Voltage

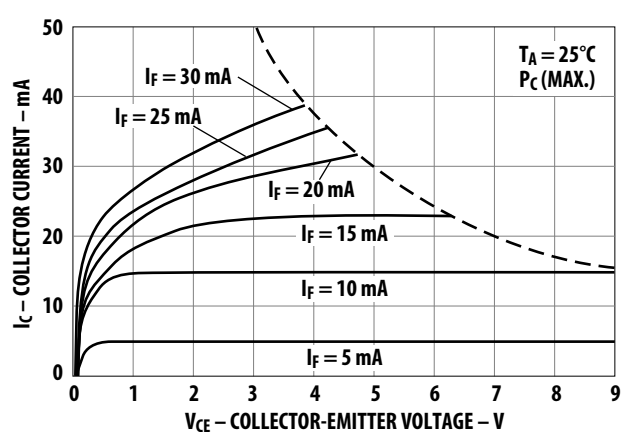

Figure 7: Relative Current Transfer Ratio vs. Temperature

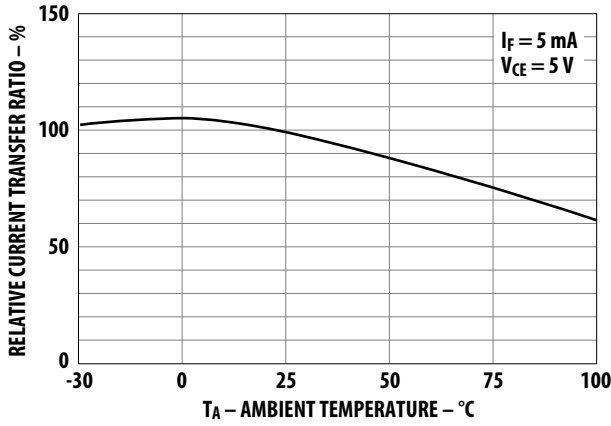

Figure 8: Collector-Emitter Saturation Voltage vs. Temperature

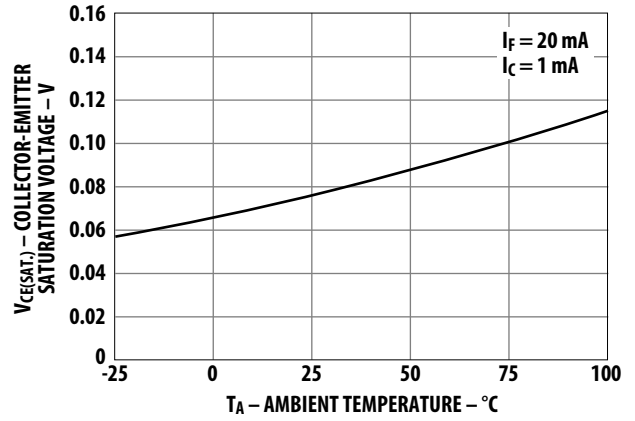

Figure 9: Collector Dark Current vs. Temperature

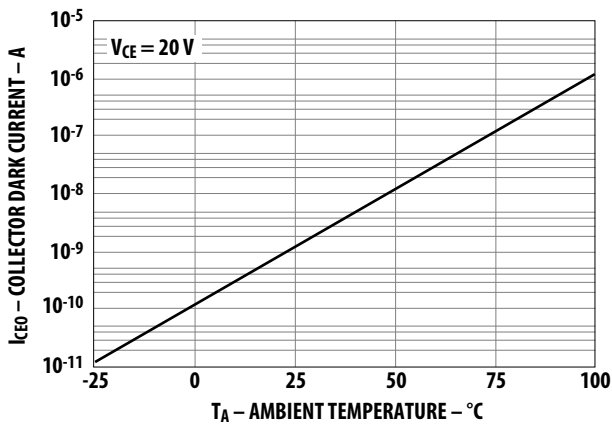

Figure 10: Response Time vs. Load Resistance

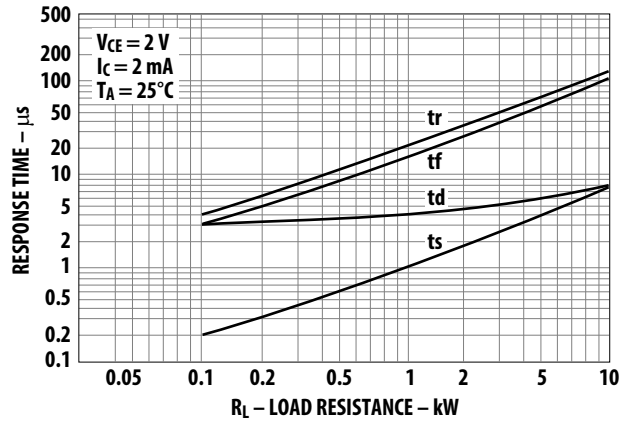

Figure 11: Frequency Response

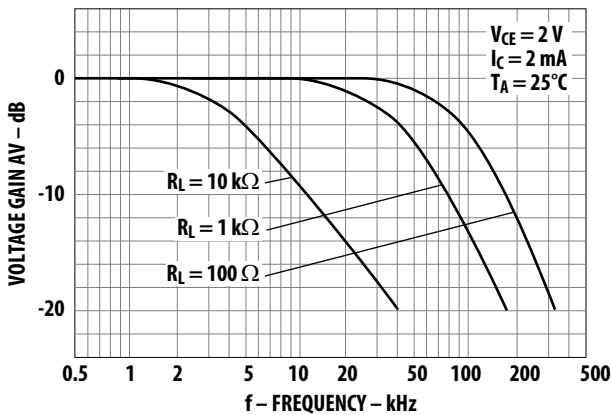

Figure 12: Test Circuit for Response Time

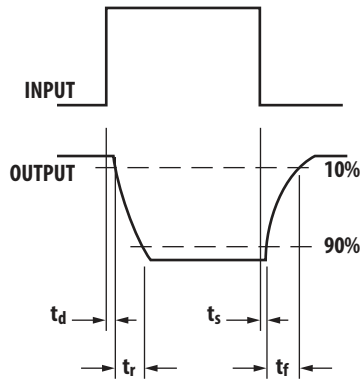
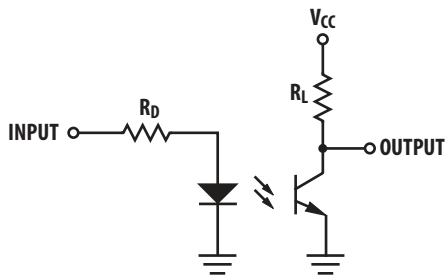
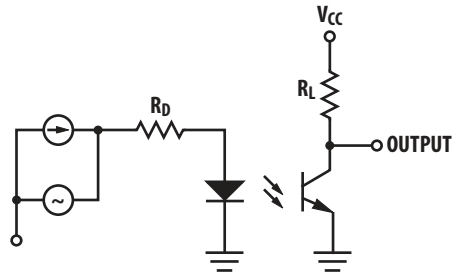

Figure 13: Test Circuit for Frequency Response



Broadcom, the pulse logo, Connecting everything, Avago Technologies, Avago, and the A logo are among the trademarks of Broadcom and/or its affiliates in the United States, certain other countries, and/or the EU.

Copyright © 2009–2021 Broadcom. All Rights Reserved.

The term “Broadcom” refers to Broadcom Inc. and/or its subsidiaries. For more information, please visit www.broadcom.com.

Broadcom reserves the right to make changes without further notice to any products or data herein to improve reliability, function, or design. Information furnished by Broadcom is believed to be accurate and reliable. However, Broadcom does not assume any liability arising out of the application or use of this information, nor the application or use of any product or circuit described herein, neither does it convey any license under its patent rights nor the rights of others.

