

SAW Filter 448MHz
Part No: MP01855

Model: TA0710A
Rev No: 1

A. MAXIMUM RATING:

1. Input Power Level: 10dBm
2. DC voltage: 3V
3. Operating Temperature: -10°C to 60°C
4. Storage Temperature: -30°C to +85°C

B. CHARACTERISTICS:

Item	Unit	Min.	Typ.	Max.
Center frequency Fc	MHz	-	448	-
Insertion loss Fc ± 1.5 MHz IL	dB	-	2.0	4.0
Amplitude ripple Fc ± 1.5 MHz	dB	-	0.5	2.0
Attenuation (Reference level from 0dB)				
Fc -44.3 ~ Fc -41.3MHz	dB	45	53	-
Fc +41.3 ~ Fc +44.3MHz	dB	45	51	-
Source impedance Z _S	Ω	-	50	-
Load impedance Z _L	Ω	-	50	-

Note: No matching network required for operation at 50Ω

C. MEASUREMENT CIRCUIT:

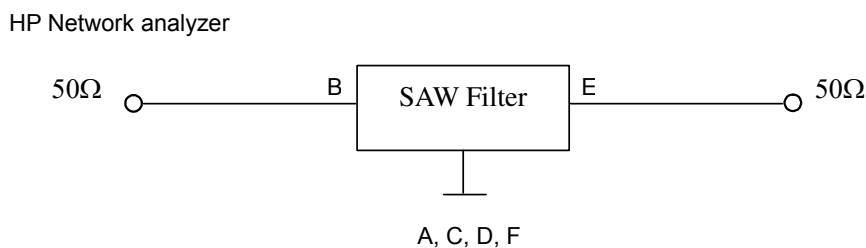

SAW Filter 448MHz
Part No: MP01855

Model: TA0710A
Rev No: 1

D. FREQUENCY CHARACTERISTICS:

Transfer Function

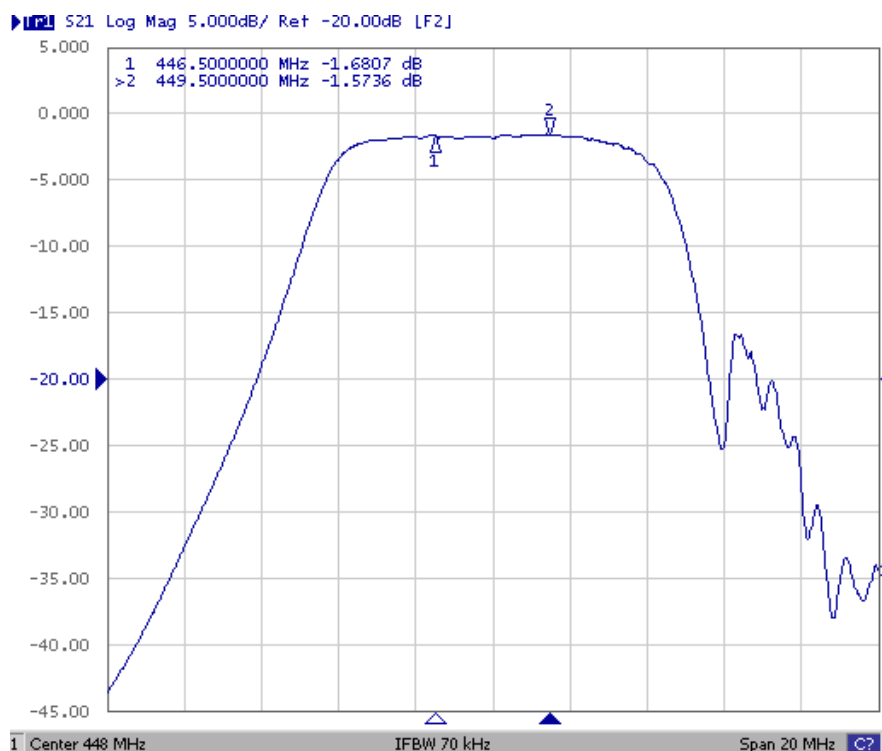
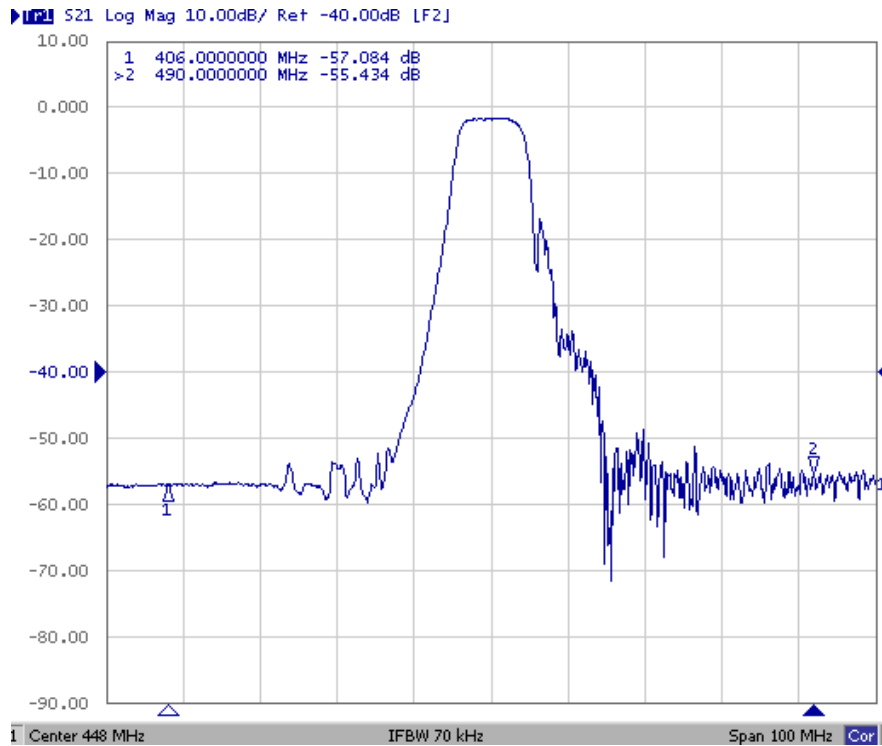

SAW Filter 448MHz
Part No: MP01855

Model: TA0710A
Rev No: 1

E. OUTLINE DRAWING:

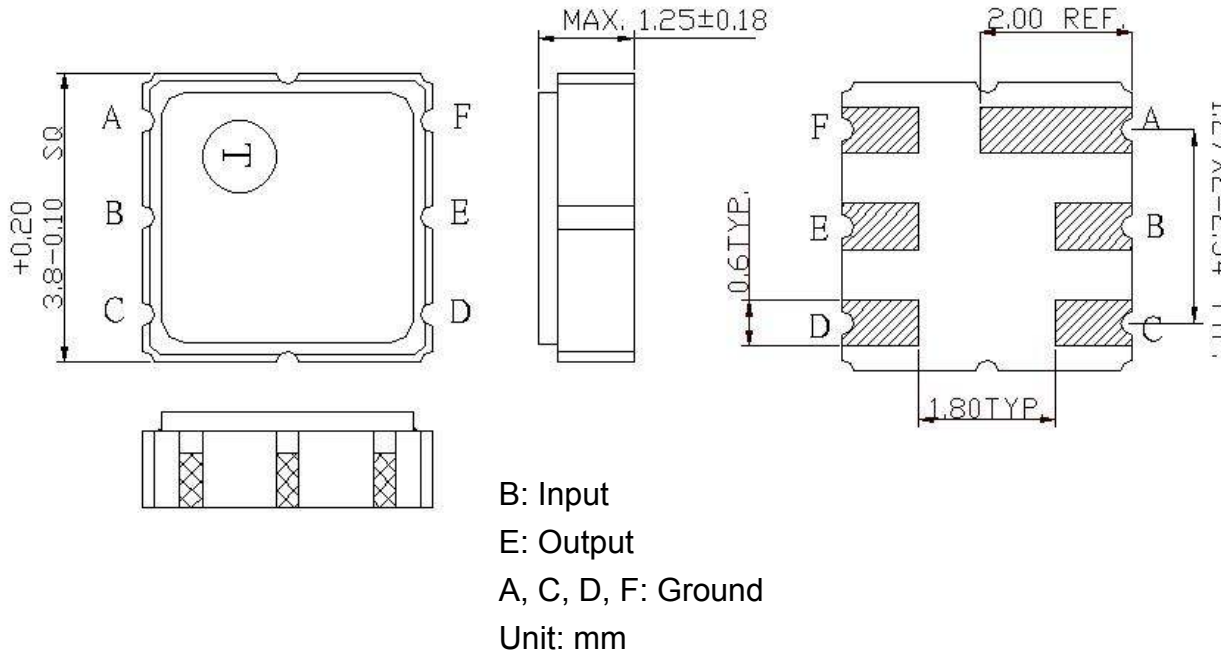

F. PCB FOOTPRINT:

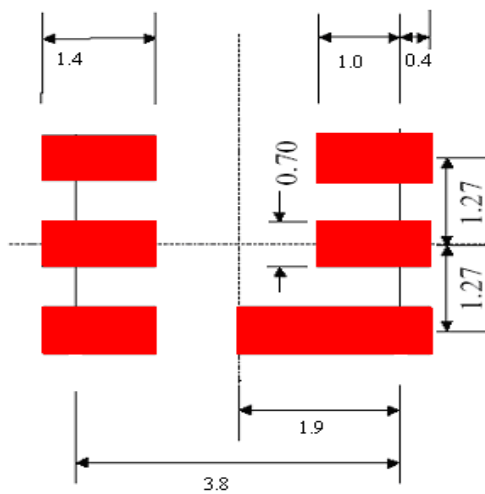

SAW Filter 448MHz
Part No: MP01855

Model: TA0710A
Rev No: 1

G. PACKING:

1. Reel Dimension

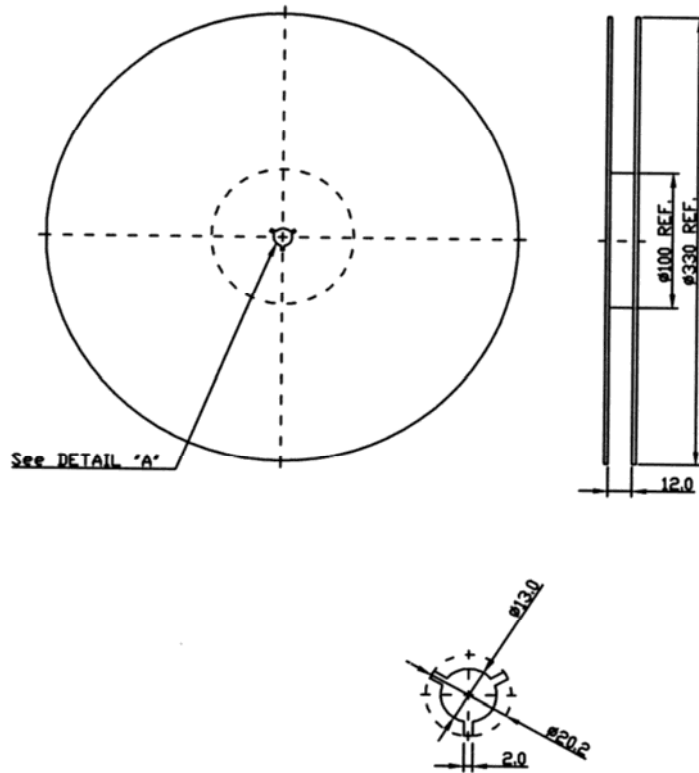

2. Tape Dimension

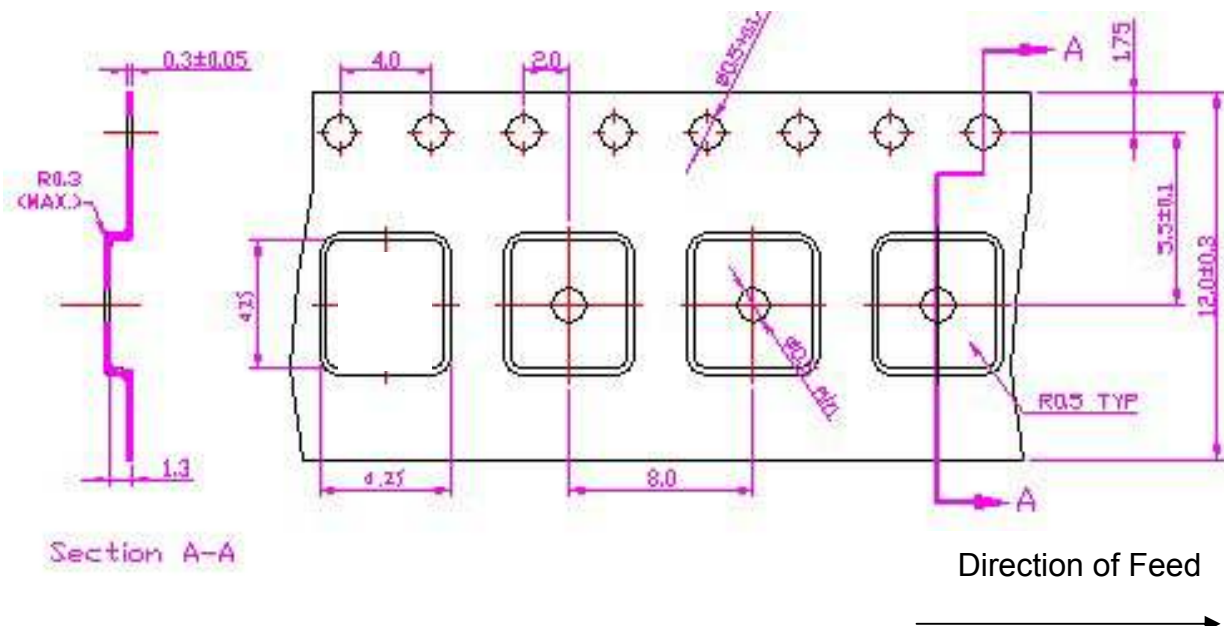

SAW Filter 448MHz
Part No: MP01855

Model: TA0710A
Rev No: 1

H. REFLOW PROFILE:

