

August 1991

### Features

- 1A and 0.8A, 80V - 100V
- $r_{DS(on)} = 0.6\Omega$  and  $0.8\Omega$
- Single Pulse Avalanche Energy Rated\*
- SOA is Power-Dissipation Limited
- Nanosecond Switching Speeds
- Linear Transfer Characteristics
- High Input Impedance

### Description

The IRFD110, IRFD111, IRFD112, and IRFD113 are n-channel enhancement-mode silicon-gate power field-effect transistors. IRFD110R, IRFD111R, IRFD112R, and IRFD113R types are advanced power MOSFETs designed, tested, and guaranteed to withstand a specified level of energy in the breakdown avalanche mode of operation. All of these power MOSFETs are designed for applications such as switching regulators, switching converters, motor drivers, relay drivers, and drivers for high-power bipolar switching transistors requiring high speed and low gate-drive power. These types can be operated directly from integrated circuits.

The IRFD types are supplied in the 4-pin dual-in-line plastic package.

### Package

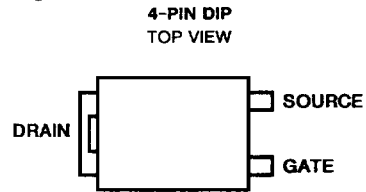

### Terminal Diagram

N-CHANNEL ENHANCEMENT MODE

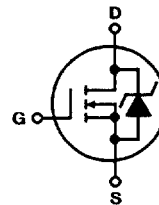

### Absolute Maximum Ratings ( $T_C = +25^\circ\text{C}$ ), Unless Otherwise Specified

	IRFD110 IRFD110R	IRFD111 IRFD111R	IRFD112 IRFD112R	IRFD113 IRFD113R	UNITS
Drain-Source Voltage (1) .....	$V_{DS}$ 100	80	100	80	V
Drain-Gate Voltage ( $R_{GS} = 20k\Omega$ ) (1) .....	$V_{DGR}$ 100	80	100	80	V
Continuous Drain Current $T_C = +25^\circ\text{C}$ .....	$I_D$ 1.0	1.0	0.8	0.8	A
Pulsed Drain Current .....	$I_{DM}$ 8.0	8.0	6.4	6.4	A
Gate-Source Voltage .....	$V_{GS}$ $\pm 20$	$\pm 20$	$\pm 20$	$\pm 20$	V
Maximum Power Dissipation $T_C = +25^\circ\text{C}$ (See Figure 13) .....	$P_D$ 1.0	1.0	1.0	1.0	W
Linear Derating Factor (See Figure 13) .....	0.008	0.008	0.008	0.008	W/ $^\circ\text{C}$
Inductive Current, Clamped (See Figure 14, $L = 100\mu\text{H}$ ) .....	$I_{LM}$ 8.0	8.0	6.4	6.4	A
Single Pulse Avalanche Energy Rating (3) .....	$E_{as}^*$ 19	19	19	19	mJ
Operating and Storage Junction Temperature Range .....	$T_J, T_{STG}$ -55 to +150	-55 to +150	-55 to +150	-55 to +150	$^\circ\text{C}$
Maximum Lead Temperature for Soldering (0.063" (1.6mm) from case for 10s) .....	$T_L$ 300	300	300	300	$^\circ\text{C}$

NOTES:

- $T_J = +25^\circ\text{C}$  to  $+150^\circ\text{C}$ .
- Pulse Test: Pulse width  $\leq 300\mu\text{s}$ , Duty Cycle  $\leq 2\%$ .
- $V_{DD} = 25\text{V}$ , starting  $T_J = +25^\circ\text{C}$ ,  $L = 28.5\text{mH}$ ,  $R_{GS} = 25\Omega$ ,  $I_{PEAK} = 1.0\text{A}$ . See Figure 15.

\* R Suffix Types Only

# IRFD110, IRFD111, IRFD112, IRFD113 IRFD110R, IRFD111R, IRFD112R, IRFD113R

Electrical Characteristics  $T_C = +25^\circ\text{C}$ , Unless Otherwise Specified

CHARACTERISTIC	SYMBOL	TEST CONDITIONS	LIMITS			UNITS
			MIN	TYP	MAX	
Drain-Source Breakdown Voltage IRFD110/112, IRFD110R/112R IRFD111/113, IRFD111R/113R	BV <sub>DSS</sub>	V <sub>GS</sub> = 0V, I <sub>D</sub> = 250μA	100	-	-	V
			80	-	-	V
Gate Threshold Voltage	V <sub>GS(TH)</sub>	V <sub>DS</sub> = V <sub>GS</sub> , I <sub>D</sub> = 250μA	2.0	-	4.0	V
Gate-Source Leakage Forward	I <sub>GSS</sub>	V <sub>GS</sub> = 20V	-	-	500	nA
Gate-Source Leakage Reverse	I <sub>GSS</sub>	V <sub>GS</sub> = -20V	-	-	-500	nA
Zero Gate Voltage Drain Current	I <sub>DSS</sub>	V <sub>DS</sub> = Max Rating, V <sub>GS</sub> = 0V	-	-	250	μA
		V <sub>DS</sub> = Max Rating x 0.8, V <sub>GS</sub> = 0V, T <sub>J</sub> = +125°C	-	-	1000	μA
On-State Drain Current (Note 2) IRFD110/111, IRFD110R/111R IRFD112/113, IRFD112R/113R	I <sub>D(ON)</sub>	V <sub>DS</sub> > I <sub>D(ON)</sub> x r <sub>DS(ON)</sub> Max, V <sub>GS</sub> = 10V	1.0	-	-	A
			0.8	-	-	A
Static Drain-Source On-State Resistance (Note 2) IRFD110/111, IRFD110R/111R IRFD112/113, IRFD112R/113R	r <sub>DS(ON)</sub>	V <sub>GS</sub> = 10V, I <sub>D</sub> = 0.8A	-	0.5	0.6	Ω
			-	0.6	0.8	Ω
Forward Transconductance (Note 2)	g <sub>fs</sub>	V <sub>DS</sub> > I <sub>D(ON)</sub> x r <sub>DS(ON)</sub> Max, I <sub>D</sub> = 0.8A	0.8	1.2	-	S(V)
Input Capacitance	C <sub>ISS</sub>	V <sub>GS</sub> = 0V, V <sub>DS</sub> = 25V, f = 1.0MHz	-	135	-	pF
Output Capacitance	C <sub>OSS</sub>	See Figure 10	-	80	-	pF
Reverse Transfer Capacitance	C <sub>RSS</sub>		-	20	-	pF
Turn-On Delay Time	t <sub>d(ON)</sub>	V <sub>DD</sub> ≈ 0.5BV <sub>DSS</sub> , I <sub>D</sub> = 1.0A, R <sub>G</sub> = 9.1Ω	-	10	20	ns
Rise Time	t <sub>r</sub>	See Figure 16. (MOSFET switching times are essentially independent of operating temperature)	-	15	25	ns
Turn-Off Delay Time	t <sub>d(OFF)</sub>		-	15	25	ns
Fall Time	t <sub>f</sub>		-	10	20	ns
Total Gate Charge (Gate-Source + Gate-Drain)	Q <sub>g</sub>	V <sub>GS</sub> = 10V, I <sub>D</sub> = 1.0A, V <sub>DS</sub> = 0.8 Max Rating. See Figure 17 for test circuit.	-	5.0	7.0	nC
Gate-Source Charge	Q <sub>gs</sub>	(Gate charge is essentially independent of operating temperature.)	-	2.0	-	nC
Gate-Drain ("Miller") Charge	Q <sub>gd</sub>		-	7.0	-	nC
Internal Drain Inductance	L <sub>D</sub>	Measured from the drain lead, 2.0mm (0.08 in.) from package to center of die.	-	4.0	-	nH
Internal Source Inductance	L <sub>S</sub>	Measured from the source lead, 2.0mm (0.08") from package to source bonding pad.	-	6.0	-	nH
Junction-to-Ambient	R <sub>θJA</sub>	Free air operation	-	-	120	°C/W

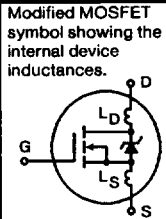

## Source Drain Diode Ratings and Characteristics

Continuous Source Current (Body Diode)	I <sub>S</sub>	Modified MOSFET symbol showing the integral reverse P-N junction rectifier.	-	-	1.0	A
Pulse Source Current (Body Diode) (Note 3)	I <sub>SM</sub>		-	-	8.0	A
Diode Forward Voltage (Note 2)	V <sub>SD</sub>	T <sub>J</sub> = +25°C, I <sub>S</sub> = 1.0A, V <sub>GS</sub> = 0V	-	-	2.5	V
Reverse Recovery Time	t <sub>rr</sub>	T <sub>J</sub> = +150°C, I <sub>F</sub> = 1.0A, dI <sub>F</sub> /dt = 100A/μs	-	100	-	ns
Reverse Recovered Charge	Q <sub>RR</sub>	T <sub>J</sub> = +150°C, I <sub>F</sub> = 1.0A, dI <sub>F</sub> /dt = 100A/μs	-	0.2	-	μC
Forward Turn-on Time	t <sub>ON</sub>	Intrinsic turn-on time is negligible. Turn-on speed is substantially controlled by L <sub>S</sub> + L <sub>D</sub> .	-	-	-	-

NOTES:

1. T<sub>J</sub> = +25°C to +150°C

2. Pulse Test: Pulse width ≤ 300μs, Duty Cycle ≤ 2%

3. V<sub>DD</sub> = 25V, starting T<sub>J</sub> = +25°C, L = 28.5mH, R<sub>GS</sub> = 25Ω, I<sub>PEAK</sub> = 1.0A. (See Figure 15.)

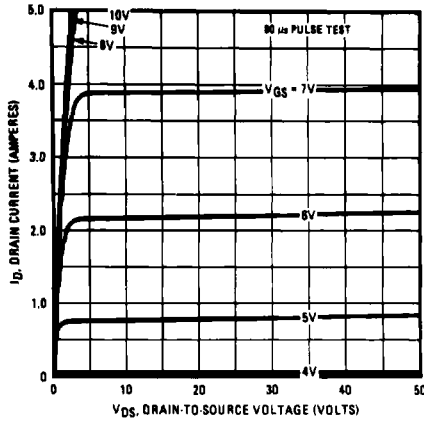

Fig. 1 - Typical Output Characteristics

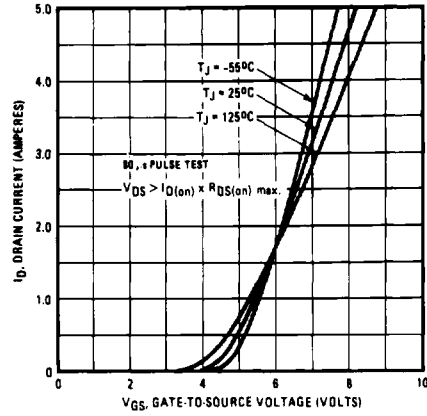

Fig. 2 - Typical Transfer Characteristics

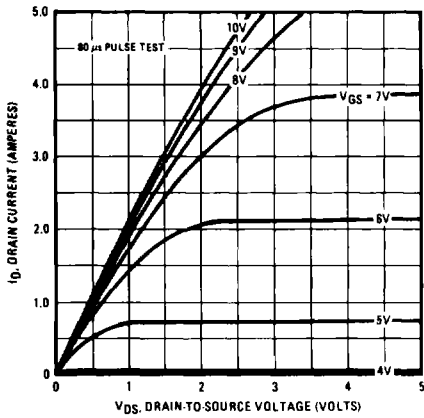

Fig. 3 - Typical Saturation Characteristics

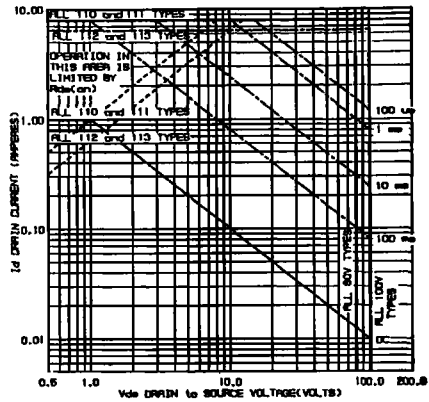

Fig. 4 - Maximum Safe Operating Area

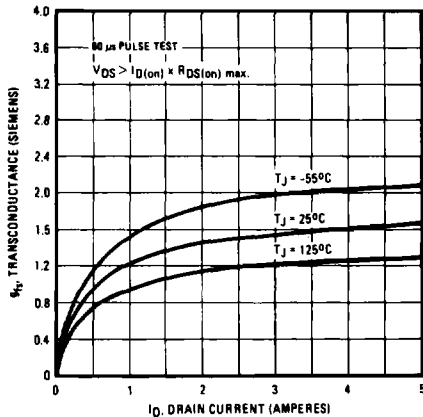

Fig. 5 - Typical Transconductance Vs. Drain Current

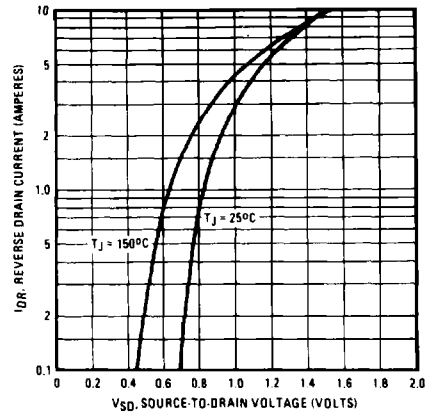

Fig. 6 - Typical Source-Drain Diode Forward Voltage

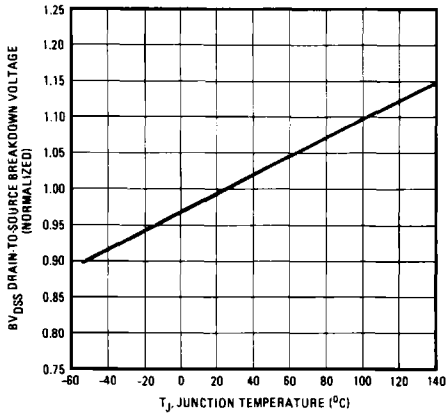

Fig. 7 - Breakdown Voltage Vs. Temperature

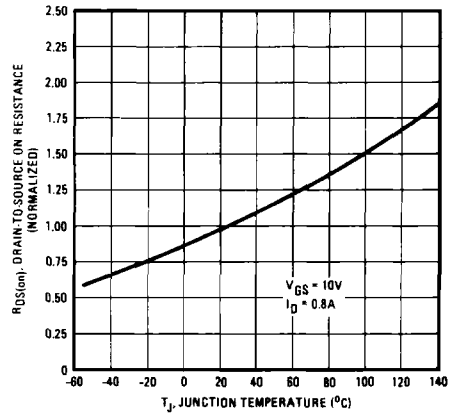

Fig. 8 - Normalized On-Resistance Vs. Temperature

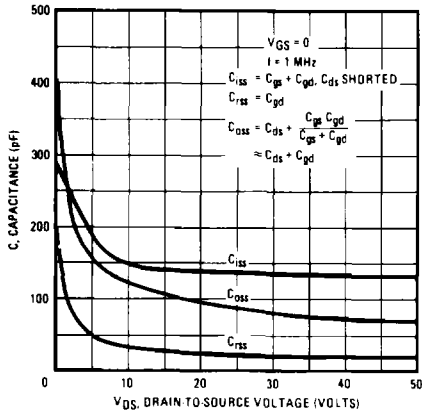

Fig. 9 - Typical Capacitance Vs. Drain-to-Source Voltage

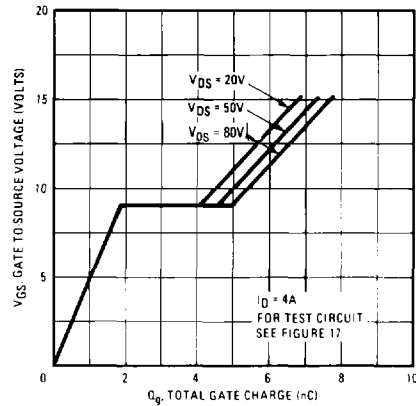

Fig. 10 - Typical Gate Charge Vs. Gate-to-Source Voltage

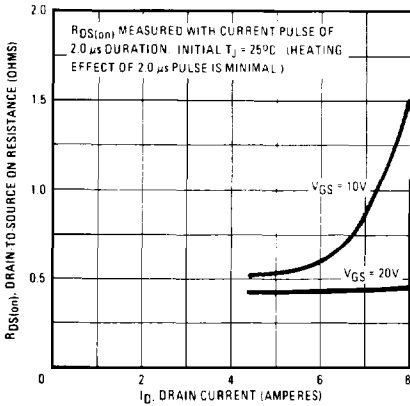

Fig. 11 - Typical On-Resistance Vs. Drain Current

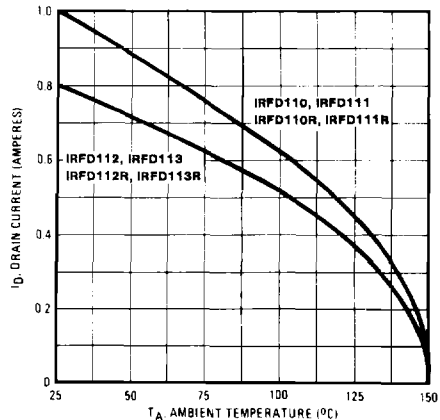

Fig. 12 - Maximum Drain Current Vs. Case Temperature

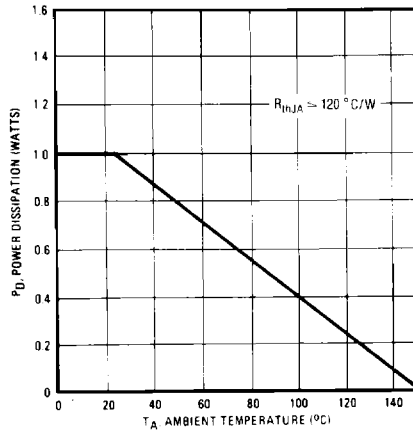

Fig. 13 - Power Vs. Temperature Derating Curve

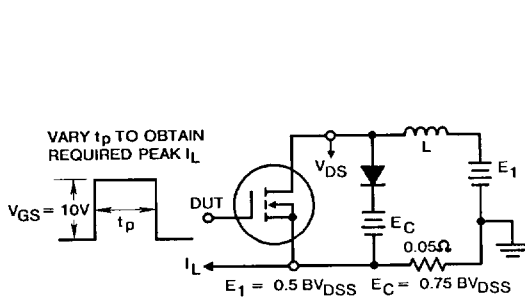

Fig. 14a - Clamped Inductive Test Circuit

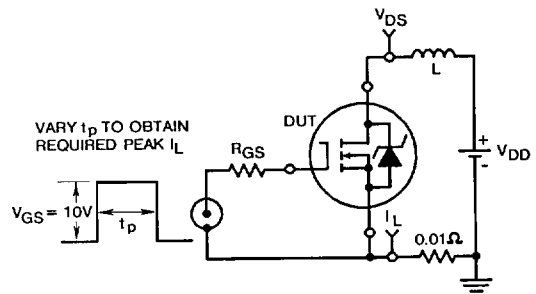

Fig. 15a - Unclamped Energy Test Circuit

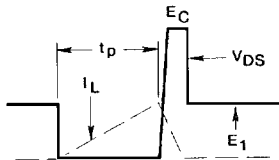

Fig. 14b - Clamped Inductive Waveforms

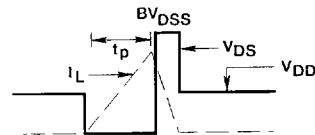

Fig. 15b - Unclamped Energy Waveforms

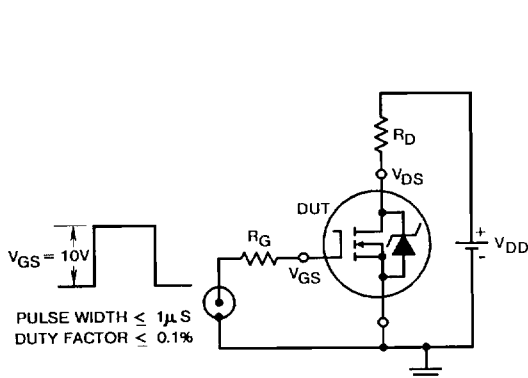

Fig. 16 - Switching Time Test Circuit

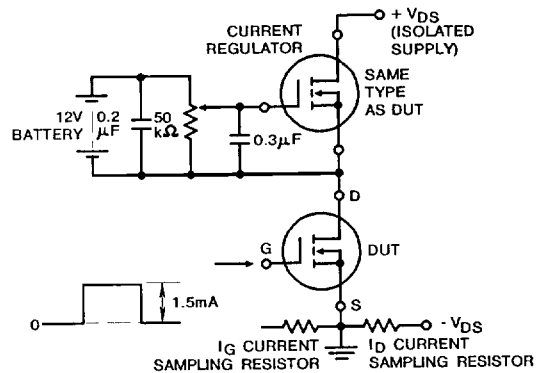

Fig. 17 - Gate Charge Test Circuit