

**ebm-papst St. Georgen GmbH & Co. KG**

Hermann-Papst-Str. 1
 D-78112 St. Georgen
 Phone +49 (0) 7724 81-0
 Fax +49 (0) 7724 81-1309
 info2@de.ebmpapst.com
 www.ebmpapst.com

Nominal data

Type	3314 NN	
Nominal voltage	VDC	24
Nominal voltage range	VDC	18 .. 28
Speed (rpm)	min ⁻¹	2650
Power consumption	W	1.8
Min. ambient temperature	°C	-20
Max. ambient temperature	°C	75
Air flow	m ³ /h	80
Sound power level	B	4.7
Sound pressure level	dB(A)	35

ml = Max. load · me = Max. efficiency · fa = Free air · cs = Customer specification · ce = Customer equipment
 Subject to change



Technical description

Housing material	Glass-fiber reinforced PBT plastic
Impeller material	Glass-fiber reinforced PA plastic
Weight	0.19 kg
Dimensions	92 x 92 x 32 mm
Airflow direction	Exhaust over struts
Direction of rotation	Clockwise, viewed toward rotor
Degree of protection	IP40
Storage	Ball bearing
Service life L10 at 40 °C	65000 h
Service life L10 at maximum temperature	27500 h
Cable	With leads AWG 24 UL 1061, TR 64



Product drawing

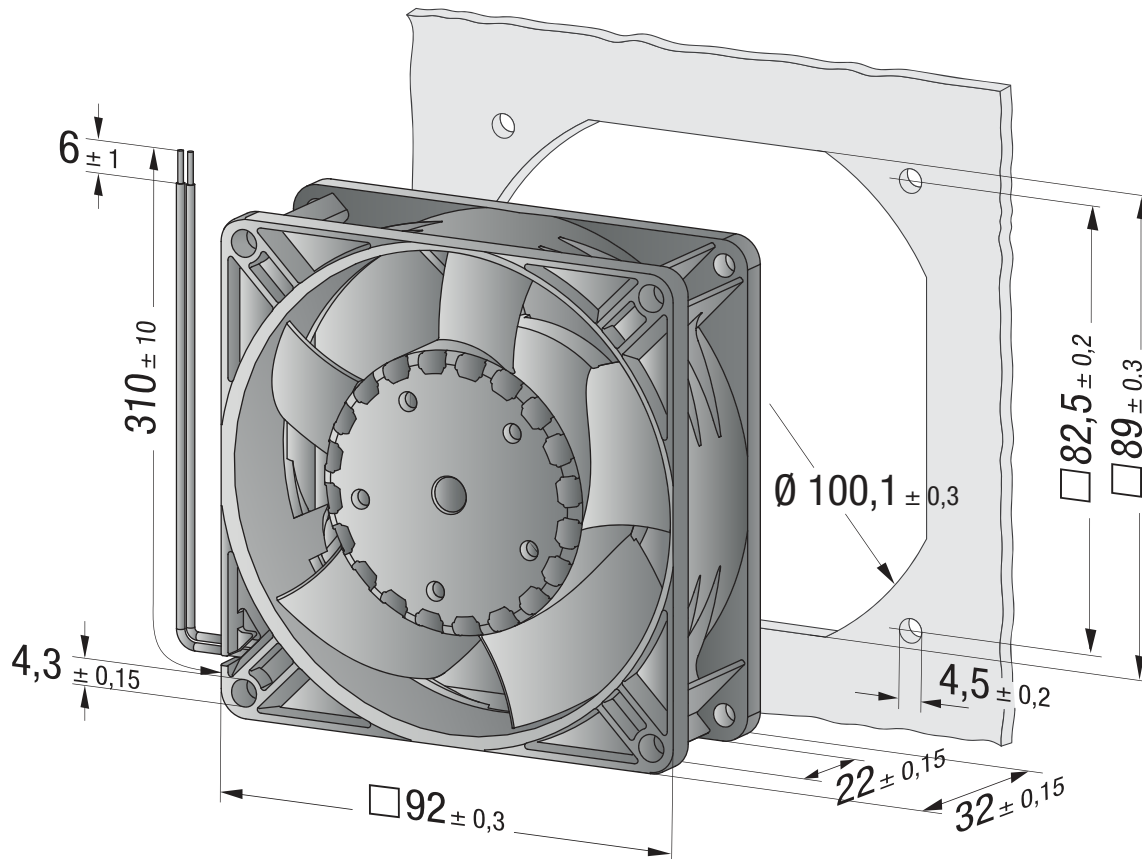

Curves

