

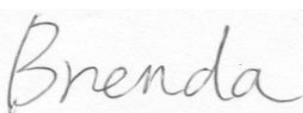

# PSE Technology Corporation

## SPECIFICATION FOR APPROVAL

CUSTOMER	_____
NOMINAL FREQUENCY	156.250000 MHz
PRODUCT TYPE	TYPE UX 5.0x3.2 SEAM SEALED CRYSTAL CLOCK OSCILLATOR
SPEC. NO. ( P/N )	UX54F62001
CUSTOMER P/N	_____
ISSUE DATE	August 12, 2015
VERSION	A

APPROVED	PREPARED	QA
		
<b>APPROVED BY CUSTOMER :</b>		<b>AVL Status</b>
<p>Please return one copy with approval to PSE-TW</p>		

### PSE Technology Corporation

No.2, Tzu-Chiang 5th Rd, Chung Li Industrial Park,  
 Chung Li City, Taoyuan County, Taiwan (R.O.C.)  
 TEL: 886-3-451-8888  
 FAX: 886-3-461-3865  
<http://www.saronix-ecera.com.tw>

- \*Pb-free
- \*RoHS Compliant
- \*HF-Halogen Free
- \*REACH Compliant

\*\*\* A company of  **PERICOM Semiconductor Corporation** \*\*\*



# TYPE UX 5.0x3.2 SEAM SEALED CRYSTAL CLOCK OSCILLATOR

## UX54F62001

VER. A 12-Aug-15

### ELECTRICAL SPECIFICATIONS

SRe Part Number : UX54F62001

Item	Symbol	Specifications	Units	Notes
Nominal Frequency	Fo	156.250000	MHz	
Frequency Stability	FT	± 50	ppm	**See note
Operating Temperature Range	TR	-40 to +85	°C	
Supply Voltage	V <sub>CC</sub>	+3.3 ± 10.0%	V	
Logic Type	LT	HCSL		
Supply Current, Output Enabled	I <sub>CC</sub> /OE	60	mA	Max.
Supply Current, Output Disabled	I <sub>CC</sub> /OD	10	uA	Max.
Duty Cycle (Symmetry)	DC/SY	45 / 55	%	Measured 50% of Waveform
Rise / Fall Time	T <sub>R</sub> /T <sub>F</sub>	0.85	ns	Max. measured from Vol=0.175V to Voh=0.525V
Output Voltage "0" Level	V <sub>OL</sub>	-0.150	V	Min. 0.0V Typ.
Output Voltage "1" Level	V <sub>OH</sub>	0.850	V	Max. 0.660V Min. 0.700V Typ.
Output Load		Rs=33Ω, Rp=50Ω, CL=2pF		Typ. In HCSL termination
Output Phase Jitter-PCIe Gen2		2.5	ps RMS	Max.
Jitter, Phase	RMS	0.11 / 0.16	ps	Typ. / Max. 12KHz ~ 20MHz Frequency Band
Jitter, Accumulated	RMS(1-σ)	4	ps	Max. 20,000 Consecutive Periods
Jitter, Peak to Peak	Pk-Pk	20 / 30	ps	Typ. / Max. 100,000 Random Periods
Phase Noise		-139	dBc/Hz	Typ. at 10kHz offset
Phase Noise		-140	dBc/Hz	Typ. at 100kHz offset
Phase Noise		-153	dBc/Hz	Typ. at 1MHz offset
Phase Noise		-160	dBc/Hz	Typ. at 10MHz offset
Phase Noise		-160	dBc/Hz	Typ. at 20MHz offset
Phase Noise		-160	dBc/Hz	Typ. at 100MHz offset
Edge Rate	Edge_rate	1.0 / 4.0	V/ns	Min. / Max., measured from -150mV to +150mV on the differential waveform
Absolute Crossing Point Voltages	V <sub>cross absolute</sub>	250 / 550	mV	Min. / Max., measured at crossing point of output and output N on the single ended waveform
Start Up Time		10	ms	Max.
Storage Temperature Range		-55 to +125	°C	

※ This product doesn't include harmful substance that stipulated by SONY SS-00259 Level 1 and S-AT2-001 Level 1 standard. RoHS Compliant (Pb - Free).

\*\*Stability includes all combinations of Operating Temperature, Load changes, rated Input (Supply) Voltage changes, Initial Calibration Tolerance (25°C), Aging (1 year at 25°C Average Effective Ambient Temperature), Shock and Vibration.

#### Output Enable / Disable Function

Parameter	Min.	Typ.	Max.	Units	Notes
Input Voltage (Pin1), Output Enable	0.7V <sub>CC</sub>			V	Or Open
Input Voltage (Pin1), Output Disable (low power standby)			0.3V <sub>CC</sub>	V	Output is Hi-Z
Output Disable Delay			200	ns	
Output Enable Delay			2	ms	

# TYPE UX 5.0x3.2 SEAM SEALED CRYSTAL CLOCK OSCILLATOR

## UX54F62001

VER. A 12-Aug-15

### TEST CIRCUIT

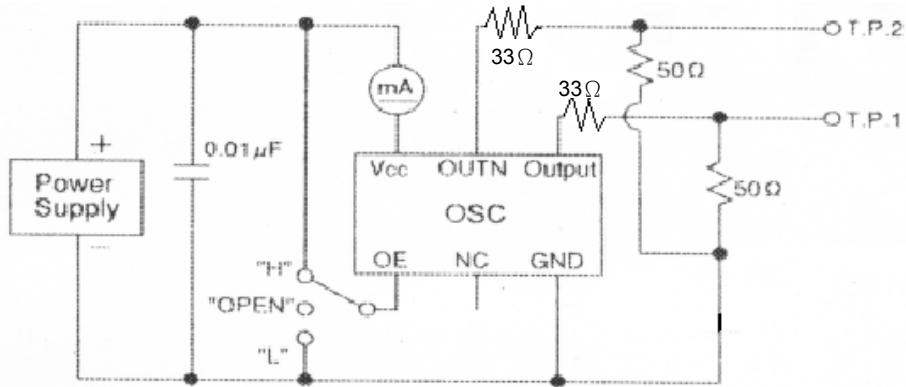

### OUTPUT WAVEFORM

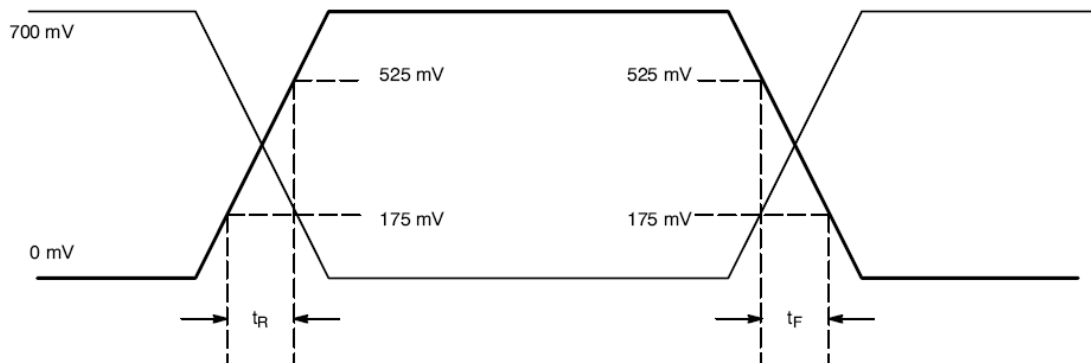

# TYPE UX 5.0x3.2 SEAM SEALED CRYSTAL CLOCK OSCILLATOR

**UX54F62001**

VER. A 12-Aug-15

## RELIABILITY SPECIFICATIONS

### ENVIRONMENTAL:

- a) THERMAL SHOCK: MIL-STD-883, Method 1011, Condition A
- b) MOISTURE RESISTANCE: MIL-STD-883, Method 1004
- c) VIBRATION: MIL-STD-883, Method 2007, Condition A
- d) RESISTANCE TO SOLDERING HEAT: J-STD-020D Table 5-2 Pb-free devices (except 2 cycles max)
- e) HAZARDOUS SUBSTANCE: Pb - free and RoHS/Green Compliant.

### MECHANICAL:

- a) SHOCK: MIL-STD-883, Method 2002, Condition B
- b) SOLDERABILITY: JESD22-B102-D Method 2 (Preconditioning E)
- c) TERMINAL STRENGTH: MIL-STD-883, Method 2004, Test Condition D
- d) GROSS LEAK: MIL-STD-883, Method 1014, Condition C
- e) FINE LEAK: MIL-STD-883, Method 1014, Condition A2,  $R1=2 \times 10^{-8}$  atm cc/s
- f) SOLVENT RESISTANCE: MIL-STD-202, Method 215

## SUGGESTED IR REFLOW PROFILE

\*As per IPC-JEDEC J-STD-020D

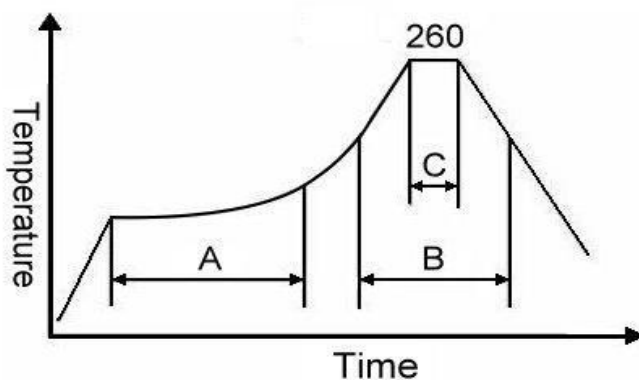

Note:

	Stage	Temperature	Time
A	Preheat	150~200°C	60~120 Sec
B	Primary Heat	217°C	60~150 Sec
C	Peak	260°C	10 Sec

For soldering reflow profile and reliability test ratings go to: <http://www.pericom.com/pdf/sre/reflow.pdf>

# TYPE UX 5.0x3.2 SEAM SEALED CRYSTAL CLOCK OSCILLATOR

**UX54F62001**

VER. A 12-Aug-15

## MARKING

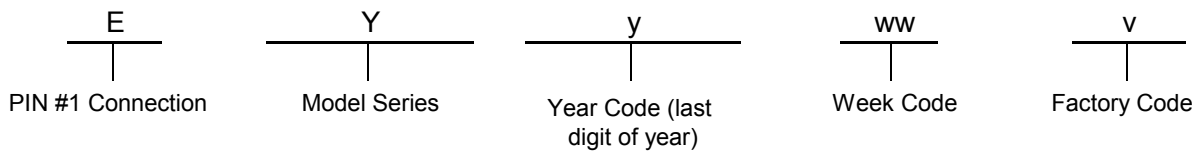
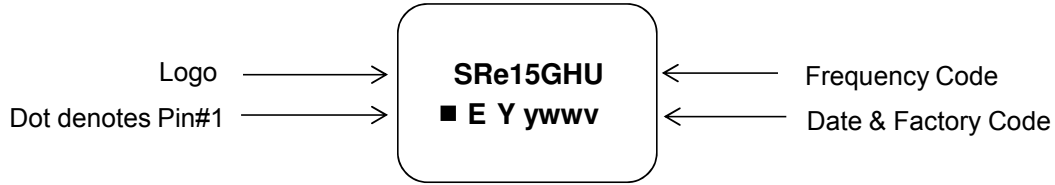

## MECHANICAL DRAWINGS ( Scale:None. Dimensions are in mm.)

Recommended Land Pattern\*

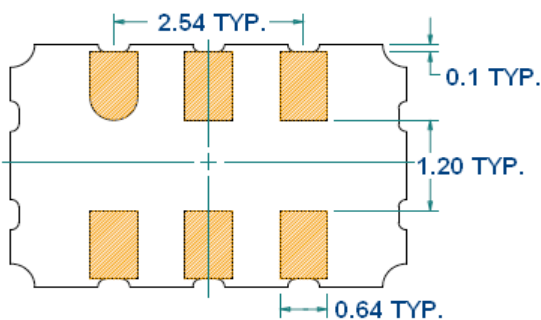
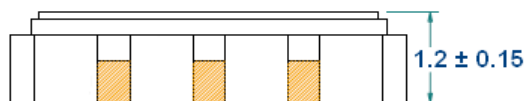
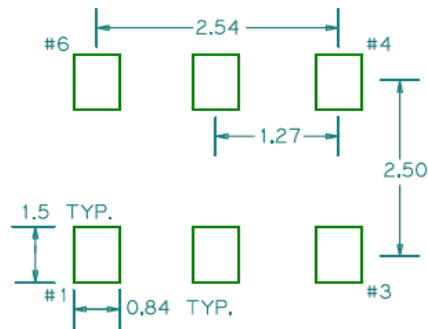
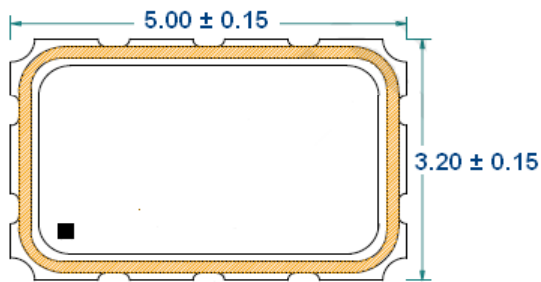

Pin	Function
1	OE
2	NC
3	V <sub>EE</sub>
4	OUTPUT
5	OUTPUT N
6	V <sub>CC</sub>

# TYPE UX 5.0x3.2 SEAM SEALED CRYSTAL CLOCK OSCILLATOR

**UX54F62001**

VER. A 12-Aug-15

## TAPE&REEL

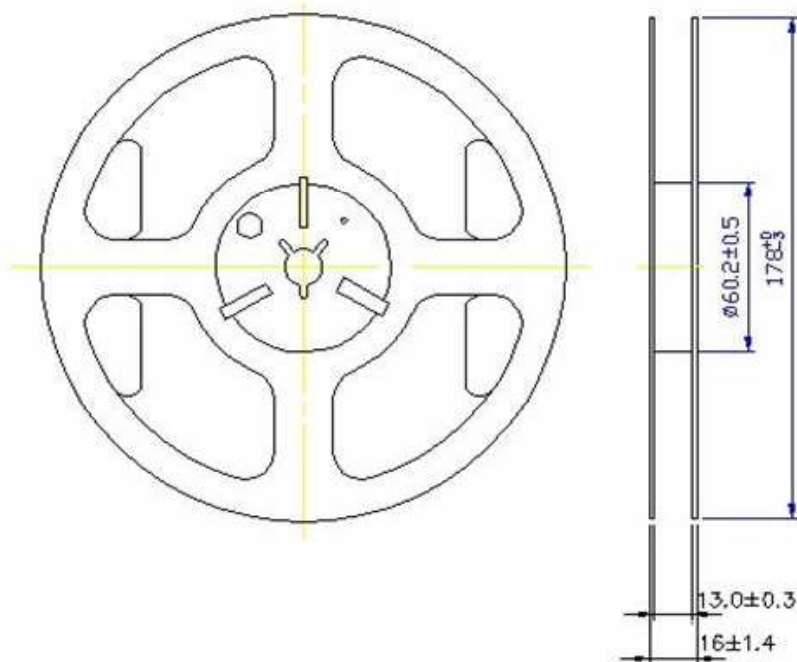
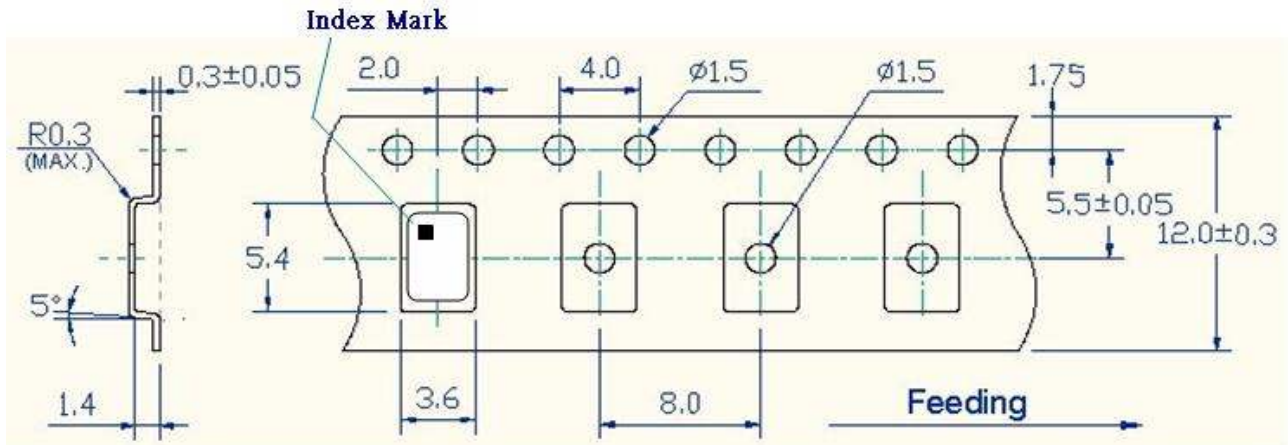

1. 230mm minimum leader which consist of carrier and/or tape followed by a minimum of 160mm of empty carrier tape sealed with cover tape.
2. 160mm minimum trailer of empty carrier tape sealed with cover tape.

# TYPE UX 5.0x3.2 SEAM SEALED CRYSTAL CLOCK OSCILLATOR

## UX54F62001

VER. A 12-Aug-15

### PACKING

