

# ON Semiconductor

## Is Now

# onsemi™

To learn more about onsemi™, please visit our website at  
[www.onsemi.com](http://www.onsemi.com)

---

**onsemi** and **onsemi** and other names, marks, and brands are registered and/or common law trademarks of Semiconductor Components Industries, LLC dba "**onsemi**" or its affiliates and/or subsidiaries in the United States and/or other countries. **onsemi** owns the rights to a number of patents, trademarks, copyrights, trade secrets, and other intellectual property. A listing of **onsemi** product/patent coverage may be accessed at [www.onsemi.com/site/pdf/Patent-Marking.pdf](http://www.onsemi.com/site/pdf/Patent-Marking.pdf). **onsemi** reserves the right to make changes at any time to any products or information herein, without notice. The information herein is provided "as-is" and **onsemi** makes no warranty, representation or guarantee regarding the accuracy of the information, product features, availability, functionality, or suitability of its products for any particular purpose, nor does **onsemi** assume any liability arising out of the application or use of any product or circuit, and specifically disclaims any and all liability, including without limitation special, consequential or incidental damages. Buyer is responsible for its products and applications using **onsemi** products, including compliance with all laws, regulations and safety requirements or standards, regardless of any support or applications information provided by **onsemi**. "Typical" parameters which may be provided in **onsemi** data sheets and/or specifications can and do vary in different applications and actual performance may vary over time. All operating parameters, including "Typicals" must be validated for each customer application by customer's technical experts. **onsemi** does not convey any license under any of its intellectual property rights nor the rights of others. **onsemi** products are not designed, intended, or authorized for use as a critical component in life support systems or any FDA Class 3 medical devices or medical devices with a same or similar classification in a foreign jurisdiction or any devices intended for implantation in the human body. Should Buyer purchase or use **onsemi** products for any such unintended or unauthorized application, Buyer shall indemnify and hold **onsemi** and its officers, employees, subsidiaries, affiliates, and distributors harmless against all claims, costs, damages, and expenses, and reasonable attorney fees arising out of, directly or indirectly, any claim of personal injury or death associated with such unintended or unauthorized use, even if such claim alleges that **onsemi** was negligent regarding the design or manufacture of the part. **onsemi** is an Equal Opportunity/Affirmative Action Employer. This literature is subject to all applicable copyright laws and is not for resale in any manner. Other names and brands may be claimed as the property of others.

# Low Noise, Audio Dual Operational Amplifier

## LM833, NCV833

The LM833 is a standard low-cost monolithic dual general-purpose operational amplifier employing Bipolar technology with innovative high-performance concepts for audio systems applications. With high frequency PNP transistors, the LM833 offers low voltage noise ( $4.5 \text{ nV}/\sqrt{\text{Hz}}$ ), 15 MHz gain bandwidth product, 7.0 V/ $\mu\text{s}$  slew rate, 0.3 mV input offset voltage with  $2.0 \mu\text{V}/^\circ\text{C}$  temperature coefficient of input offset voltage. The LM833 output stage exhibits no dead-band crossover distortion, large output voltage swing, excellent phase and gain margins, low open loop high frequency output impedance and symmetrical source/sink AC frequency response.

For an improved performance dual/quad version, see the MC33079 family.

### Features

- Low Voltage Noise:  $4.5 \text{ nV}/\sqrt{\text{Hz}}$
- High Gain Bandwidth Product: 15 MHz
- High Slew Rate: 7.0 V/ $\mu\text{s}$
- Low Input Offset Voltage: 0.3 mV
- Low T.C. of Input Offset Voltage:  $2.0 \mu\text{V}/^\circ\text{C}$
- Low Distortion: 0.002%
- Excellent Frequency Stability
- Dual Supply Operation
- NCV Prefix for Automotive and Other Applications Requiring Site and Change Controls
- These Devices are Pb-Free and are RoHS Compliant

### MAXIMUM RATINGS

Rating	Symbol	Value	Unit
Supply Voltage ( $V_{CC}$ to $V_{EE}$ )	$V_S$	+36	V
Input Differential Voltage Range (Note 1)	$V_{IDR}$	30	V
Input Voltage Range (Note 1)	$V_{IR}$	$\pm 15$	V
Output Short Circuit Duration (Note 2)	$t_{SC}$	Indefinite	
Operating Ambient Temperature Range	$T_A$	-40 to +85	$^\circ\text{C}$
Operating Junction Temperature	$T_J$	+150	$^\circ\text{C}$
Storage Temperature	$T_{stg}$	-60 to +150	$^\circ\text{C}$
ESD Protection at any Pin – Human Body Model – Machine Model	$V_{esd}$	600 200	V
Maximum Power Dissipation (Notes 2 and 3)	$P_D$	500	mW

Stresses exceeding those listed in the Maximum Ratings table may damage the device. If any of these limits are exceeded, device functionality should not be assumed, damage may occur and reliability may be affected.

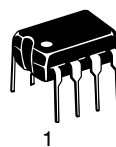
1. Either or both input voltages must not exceed the magnitude of  $V_{CC}$  or  $V_{EE}$ .
2. Power dissipation must be considered to ensure maximum junction temperature ( $T_J$ ) is not exceeded (see power dissipation performance characteristic).
3. Maximum value at  $T_A \leq 85^\circ\text{C}$ .



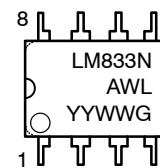
ON Semiconductor®

[www.onsemi.com](http://www.onsemi.com)

### MARKING DIAGRAMS



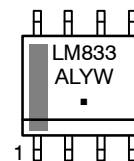
PDIP-8  
N SUFFIX  
CASE 626



LM833N = Device Code  
A = Assembly Location  
WL = Wafer Lot  
YY = Year  
WW = Work Week  
G = Pb-Free Package

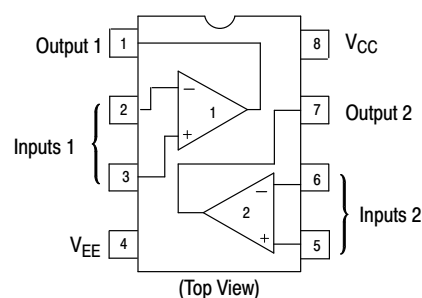


SOIC-8  
D SUFFIX  
CASE 751



LM833 = Device Code  
A = Assembly Location  
L = Wafer Lot  
Y = Year  
W = Work Week  
▪ = Pb-Free Package

### PIN CONNECTIONS



### ORDERING INFORMATION

See detailed ordering and shipping information in the package dimensions section on page 6 of this data sheet.

# LM833, NCV833

## ELECTRICAL CHARACTERISTICS ( $V_{CC} = +15\text{ V}$ , $V_{EE} = -15\text{ V}$ , $T_A = 25^\circ\text{C}$ , unless otherwise noted.)

Characteristic	Symbol	Min	Typ	Max	Unit
Input Offset Voltage ( $R_S = 10\ \Omega$ , $V_O = 0\text{ V}$ )	$V_{IO}$	-	0.3	5.0	mV
Average Temperature Coefficient of Input Offset Voltage $R_S = 10\ \Omega$ , $V_O = 0\text{ V}$ , $T_A = T_{low}$ to $T_{high}$	$\Delta V_{IO}/\Delta T$	-	2.0	-	$\mu\text{V}/^\circ\text{C}$
Input Offset Current ( $V_{CM} = 0\text{ V}$ , $V_O = 0\text{ V}$ )	$I_{IO}$	-	10	200	nA
Input Bias Current ( $V_{CM} = 0\text{ V}$ , $V_O = 0\text{ V}$ )	$I_{IB}$	-	300	1000	nA
Common Mode Input Voltage Range	$V_{ICR}$	-12	+14 -14	+12 -	V
Large Signal Voltage Gain ( $R_L = 2.0\text{ k}\Omega$ , $V_O = \pm 10\text{ V}$ )	$A_{VOL}$	90	110	-	dB
Output Voltage Swing: $R_L = 2.0\text{ k}\Omega$ , $V_{ID} = 1.0\text{ V}$ $R_L = 2.0\text{ k}\Omega$ , $V_{ID} = 1.0\text{ V}$ $R_L = 10\text{ k}\Omega$ , $V_{ID} = 1.0\text{ V}$ $R_L = 10\text{ k}\Omega$ , $V_{ID} = 1.0\text{ V}$	$V_{O+}$ $V_{O-}$ $V_{O+}$ $V_{O-}$	10 - 12 -	13.7 -14.1 13.9 -14.7	- -10 - -12	V
Common Mode Rejection ( $V_{in} = \pm 12\text{ V}$ )	CMR	80	100	-	dB
Power Supply Rejection ( $V_S = 15\text{ V}$ to $5.0\text{ V}$ , $-15\text{ V}$ to $-5.0\text{ V}$ )	PSR	80	115	-	dB
Power Supply Current ( $V_O = 0\text{ V}$ , Both Amplifiers)	$I_D$	-	4.0	8.0	mA

## AC ELECTRICAL CHARACTERISTICS ( $V_{CC} = +15\text{ V}$ , $V_{EE} = -15\text{ V}$ , $T_A = 25^\circ\text{C}$ , unless otherwise noted.)

Characteristic	Symbol	Min	Typ	Max	Unit
Slew Rate ( $V_{in} = -10\text{ V}$ to $+10\text{ V}$ , $R_L = 2.0\text{ k}\Omega$ , $A_V = +1.0$ )	$S_R$	5.0	7.0	-	$\text{V}/\mu\text{s}$
Gain Bandwidth Product ( $f = 100\text{ kHz}$ )	GBW	10	15	-	MHz
Unity Gain Frequency (Open Loop)	$f_U$	-	9.0	-	MHz
Unity Gain Phase Margin (Open Loop)	$\theta_m$	-	60	-	$^\circ$
Equivalent Input Noise Voltage ( $R_S = 100\ \Omega$ , $f = 1.0\text{ kHz}$ )	$e_n$	-	4.5	-	$\text{nV}/\sqrt{\text{Hz}}$
Equivalent Input Noise Current ( $f = 1.0\text{ kHz}$ )	$i_n$	-	0.5	-	$\text{pA}/\sqrt{\text{Hz}}$
Power Bandwidth ( $V_O = 27\text{ V}_{pp}$ , $R_L = 2.0\text{ k}\Omega$ , $\text{THD} \leq 1.0\%$ )	BWP	-	120	-	kHz
Distortion ( $R_L = 2.0\text{ k}\Omega$ , $f = 20\text{ Hz}$ to $20\text{ kHz}$ , $V_O = 3.0\text{ V}_{rms}$ , $A_V = +1.0$ )	THD	-	0.002	-	%
Channel Separation ( $f = 20\text{ Hz}$ to $20\text{ kHz}$ )	$C_S$	-	-120	-	dB

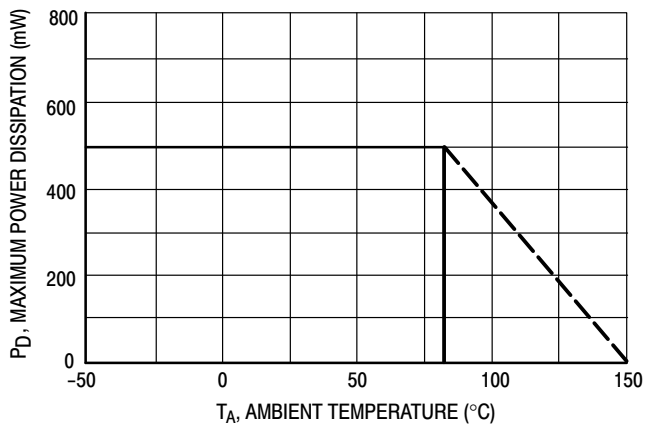


Figure 1. Maximum Power Dissipation versus Temperature

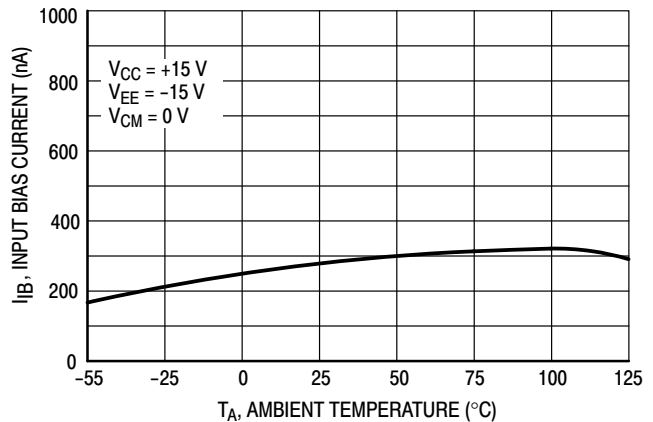
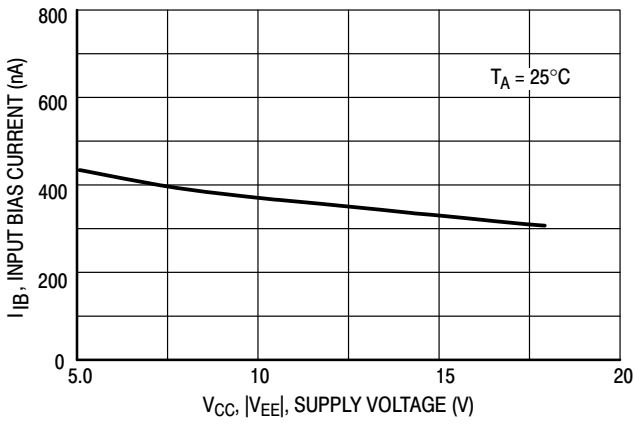
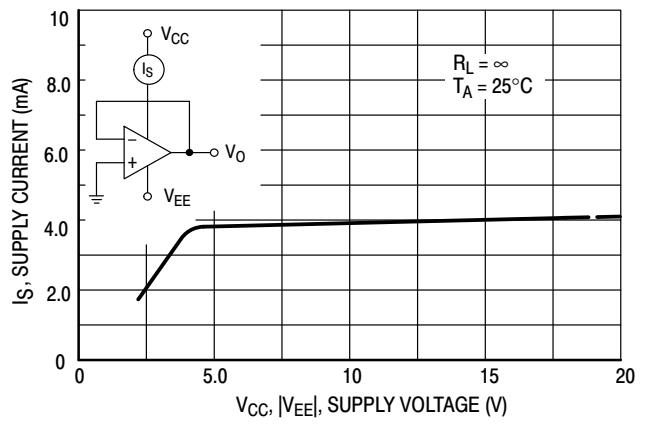


Figure 2. Input Bias Current versus Temperature

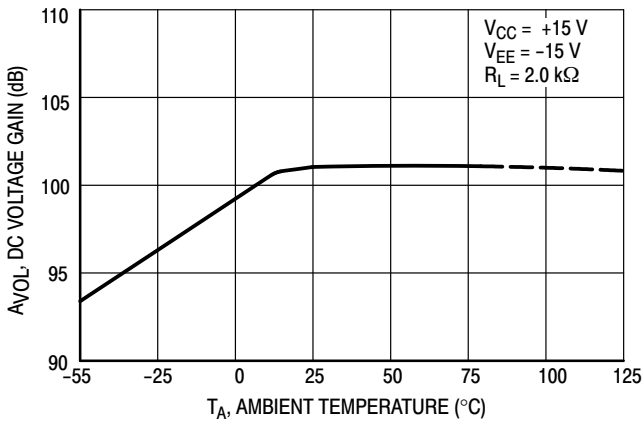
# LM833, NCV833



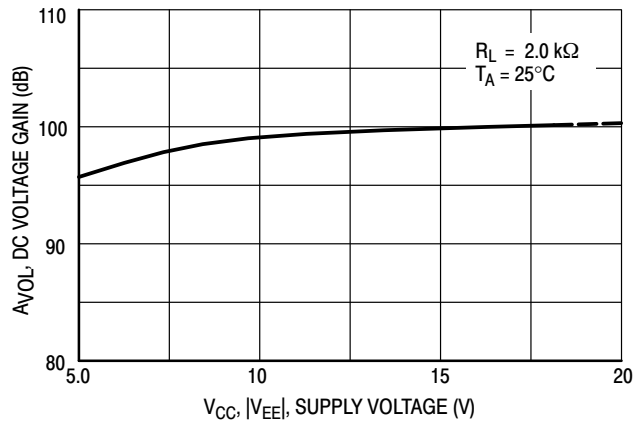
**Figure 3. Input Bias Current versus Supply Voltage**



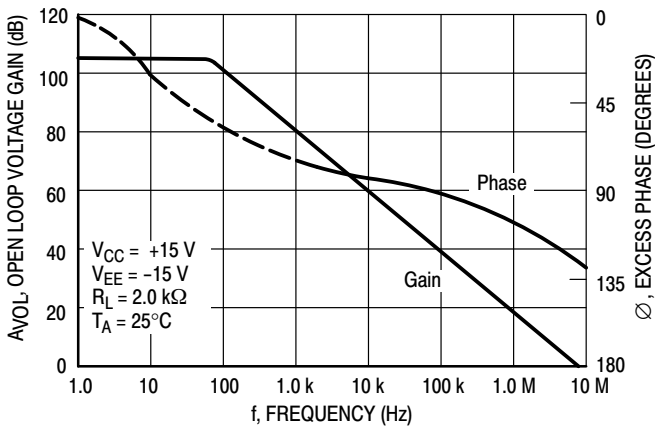
**Figure 4. Supply Current versus Supply Voltage**



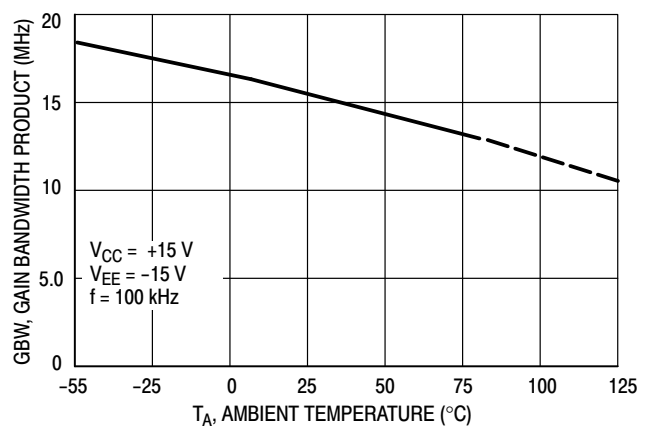
**Figure 5. DC Voltage Gain versus Temperature**



**Figure 6. DC Voltage Gain versus Supply Voltage**

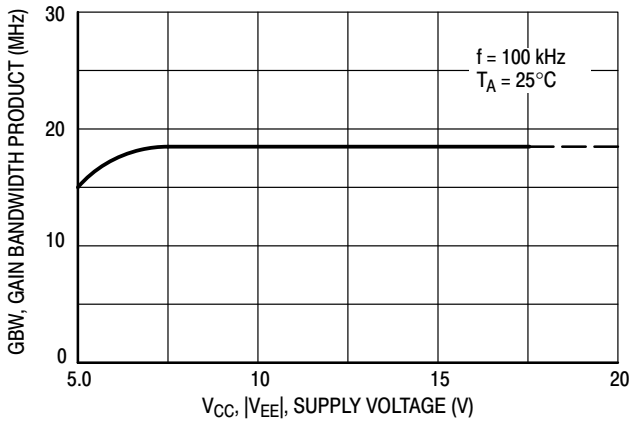


**Figure 7. Open Loop Voltage Gain and Phase versus Frequency**

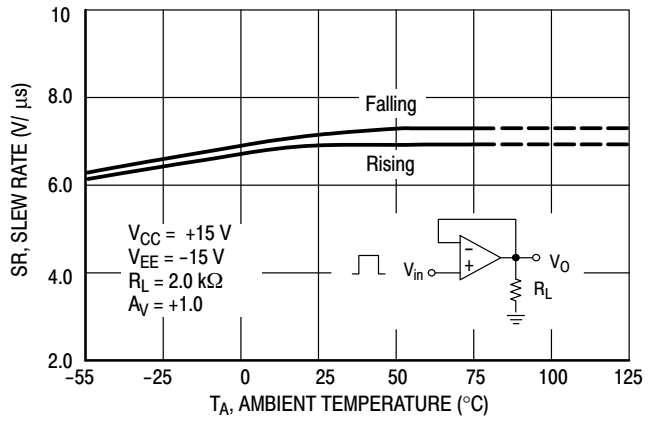


**Figure 8. Gain Bandwidth Product versus Temperature**

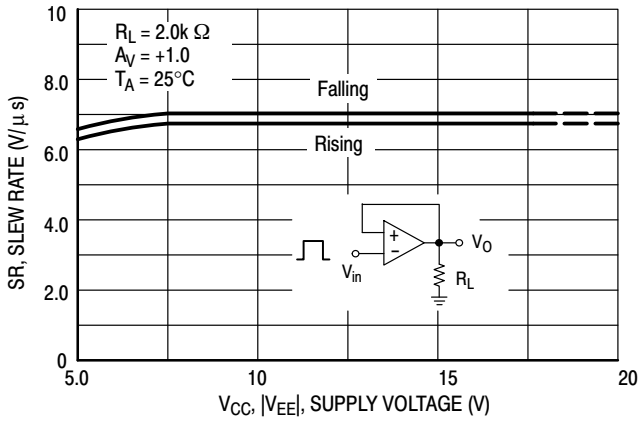
# LM833, NCV833



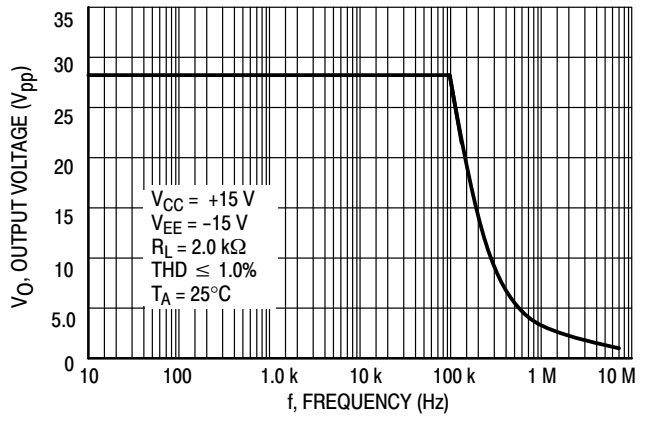
**Figure 9. Gain Bandwidth Product versus Supply Voltage**



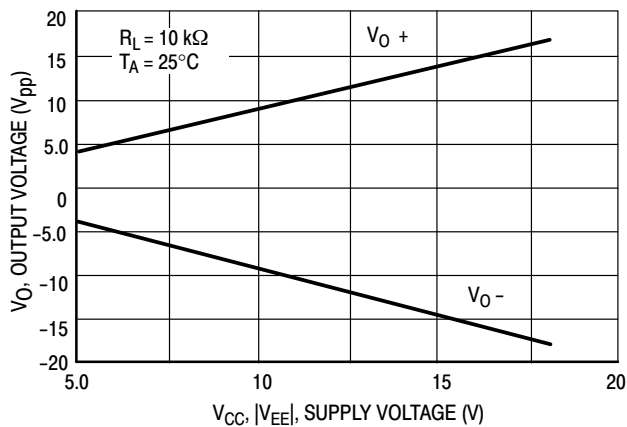
**Figure 10. Slew Rate versus Temperature**



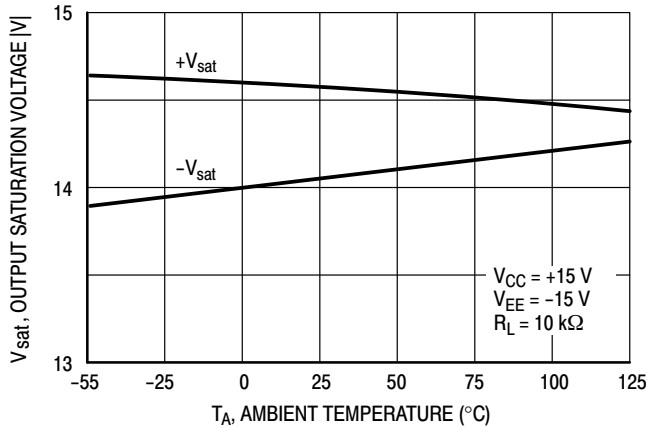
**Figure 11. Slew Rate versus Supply Voltage**



**Figure 12. Output Voltage versus Frequency**

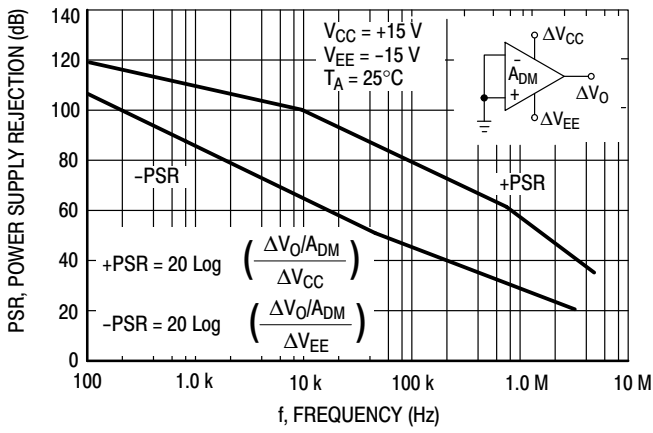


**Figure 13. Maximum Output Voltage versus Supply Voltage**

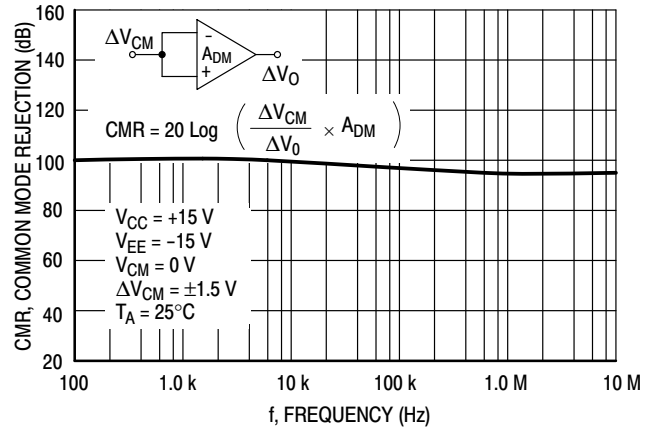


**Figure 14. Output Saturation Voltage versus Temperature**

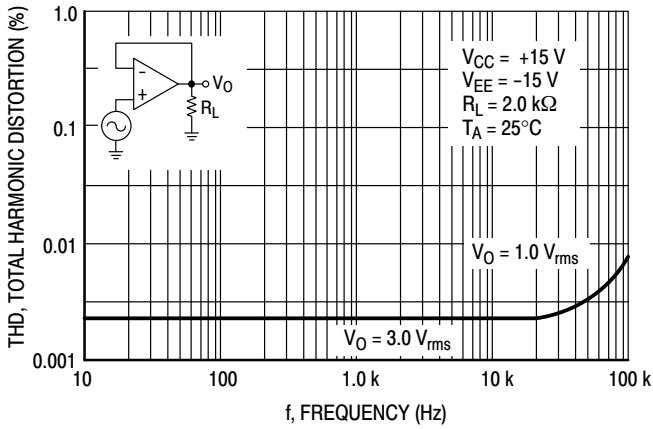
# LM833, NCV833



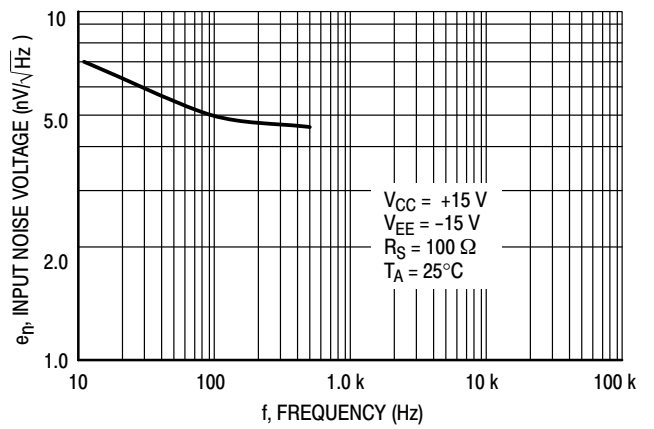
**Figure 15. Power Supply Rejection versus Frequency**



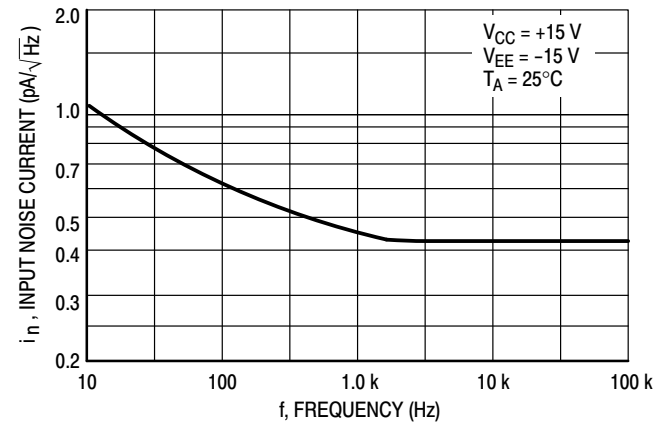
**Figure 16. Common Mode Rejection versus Frequency**



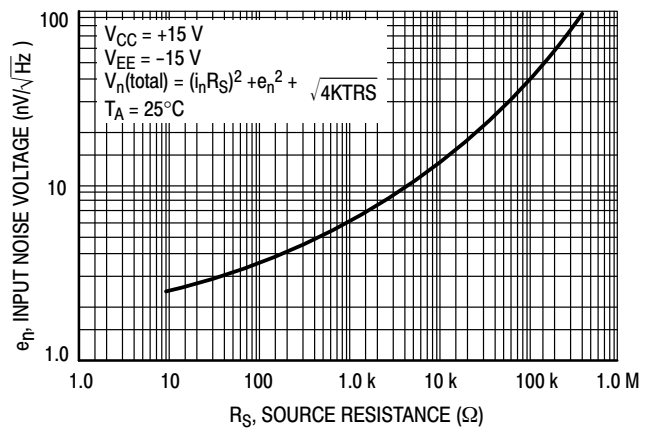
**Figure 17. Total Harmonic Distortion versus Frequency**



**Figure 18. Input Referred Noise Voltage versus Frequency**



**Figure 19. Input Referred Noise Current versus Frequency**



**Figure 20. Input Referred Noise Voltage versus Source Resistance**

# LM833, NCV833

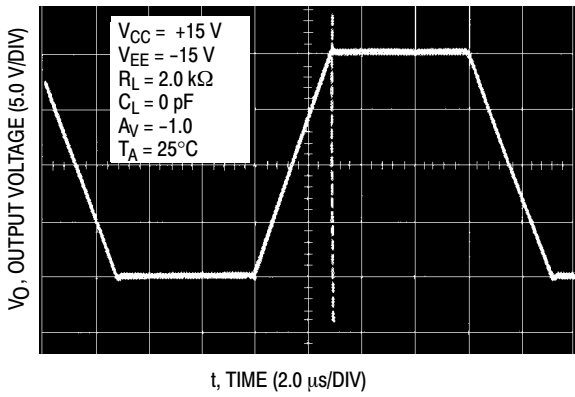


Figure 21. Inverting Amplifier

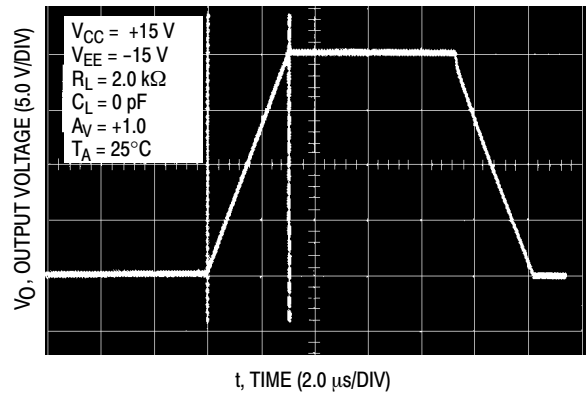


Figure 22. Noninverting Amplifier Slew Rate

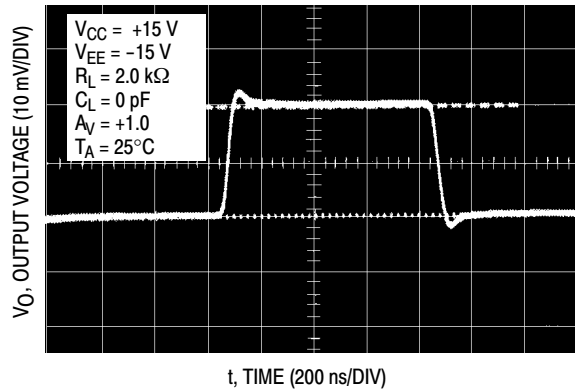


Figure 23. Noninverting Amplifier Overshoot

## ORDERING INFORMATION

Device	Package	Shipping <sup>†</sup>
LM833NG	PDIP-8 (Pb-Free)	50 Units / Rail
LM833DG	SOIC-8 (Pb-Free)	98 Units / Rail
LM833DR2G	SOIC-8 (Pb-Free)	2500 / Tape & Reel
NCV833DR2G*	SOIC-8 (Pb-Free)	2500 / Tape & Reel

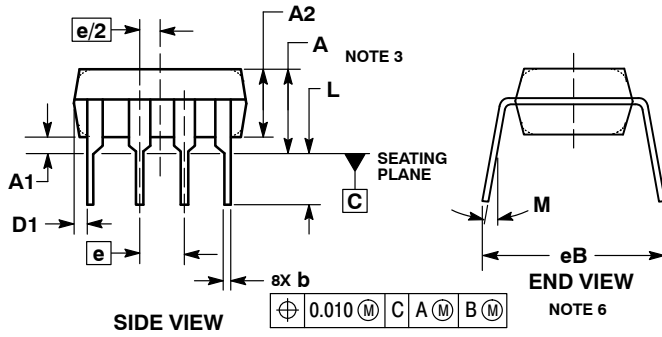
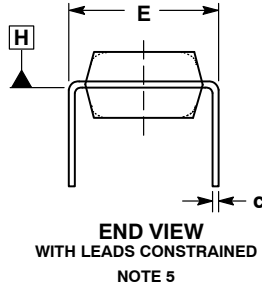
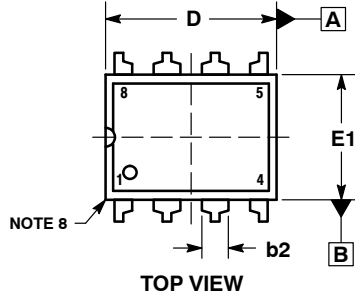
<sup>†</sup>For information on tape and reel specifications, including part orientation and tape sizes, please refer to our Tape and Reel Packaging Specifications Brochure, BRD8011/D.

\*NCV prefix indicates qualified for automotive use.

# LM833, NCV833

## PACKAGE DIMENSIONS

PDIP-8  
N SUFFIX  
CASE 626-05  
ISSUE M



**NOTES:**

1. DIMENSIONING AND TOLERANCING PER ASME Y14.5M, 1994.
2. CONTROLLING DIMENSION: INCHES.
3. DIMENSIONS A, A1 AND L ARE MEASURED WITH THE PACKAGE SEATED IN JEDEC SEATING PLANE GAUGE GS-3.
4. DIMENSIONS D, D1 AND E1 DO NOT INCLUDE MOLD FLASH OR PROTRUSIONS. MOLD FLASH OR PROTRUSIONS ARE NOT TO EXCEED 0.10 INCH.
5. DIMENSION E IS MEASURED AT A POINT 0.015 BELOW DATUM PLANE H WITH THE LEADS CONSTRAINED PERPENDICULAR TO DATUM C.
6. DIMENSION eB IS MEASURED AT THE LEAD TIPS WITH THE LEADS UNCONSTRAINED.
7. DATUM PLANE H IS COINCIDENT WITH THE BOTTOM OF THE LEADS, WHERE THE LEADS EXIT THE BODY.
8. PACKAGE CONTOUR IS OPTIONAL (ROUNDED OR SQUARE CORNERS).

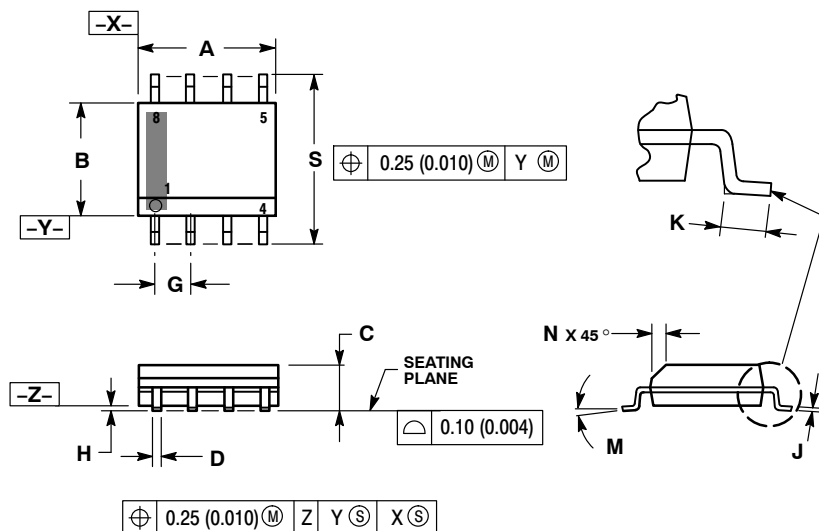
DIM	INCHES		MILLIMETERS	
	MIN	MAX	MIN	MAX
A	----	0.210	----	5.33
A1	0.015	----	0.38	----
A2	0.115	0.195	2.92	4.95
b	0.014	0.022	0.35	0.56
b2	0.060 TYP		1.52 TYP	
C	0.008	0.014	0.20	0.36
D	0.355	0.400	9.02	10.16
D1	0.005	----	0.13	----
E	0.300	0.325	7.62	8.26
E1	0.240	0.280	6.10	7.11
e	0.100 BSC		2.54 BSC	
eB	----	0.430	----	10.92
L	0.115	0.150	2.92	3.81
M	----	10°	----	10°



# LM833, NCV833

## PACKAGE DIMENSIONS

SOIC-8  
D SUFFIX  
CASE 751-07  
ISSUE AK

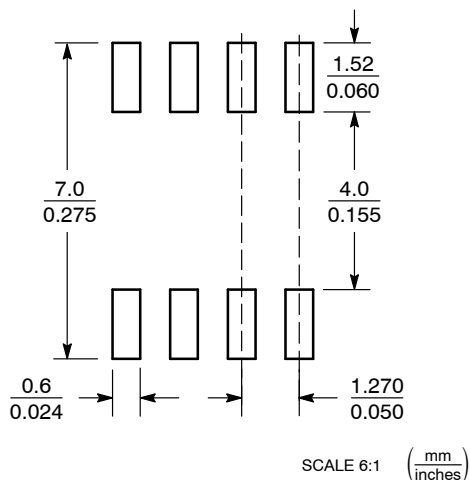


**NOTES:**

1. DIMENSIONING AND TOLERANCING PER ANSI Y14.5M, 1982.
2. CONTROLLING DIMENSION: MILLIMETER.
3. DIMENSION A AND B DO NOT INCLUDE MOLD PROTRUSION.
4. MAXIMUM MOLD PROTRUSION 0.15 (0.006) PER SIDE.
5. DIMENSION D DOES NOT INCLUDE DAMBAR PROTRUSION. ALLOWABLE DAMBAR PROTRUSION SHALL BE 0.127 (0.005) TOTAL IN EXCESS OF THE D DIMENSION AT MAXIMUM MATERIAL CONDITION.
6. 751-01 THRU 751-06 ARE OBSOLETE. NEW STANDARD IS 751-07.

DIM	MILLIMETERS		INCHES	
	MIN	MAX	MIN	MAX
A	4.80	5.00	0.189	0.197
B	3.80	4.00	0.150	0.157
C	1.35	1.75	0.053	0.069
D	0.33	0.51	0.013	0.020
G	1.27 BSC		0.050 BSC	
H	0.10	0.25	0.004	0.010
J	0.19	0.25	0.007	0.010
K	0.40	1.27	0.016	0.050
M	0°	8°	0°	8°
N	0.25	0.50	0.010	0.020
S	5.80	6.20	0.228	0.244

### SOLDERING FOOTPRINT\*



\*For additional information on our Pb-Free strategy and soldering details, please download the ON Semiconductor Soldering and Mounting Techniques Reference Manual, SOLDERRM/D.

ON Semiconductor and are trademarks of Semiconductor Components Industries, LLC dba ON Semiconductor or its subsidiaries in the United States and/or other countries. ON Semiconductor owns the rights to a number of patents, trademarks, copyrights, trade secrets, and other intellectual property. A listing of ON Semiconductor's product/patent coverage may be accessed at [www.onsemi.com/site/pdf/Patent-Marking.pdf](http://www.onsemi.com/site/pdf/Patent-Marking.pdf). ON Semiconductor reserves the right to make changes without further notice to any products herein. ON Semiconductor makes no warranty, representation or guarantee regarding the suitability of its products for any particular purpose, nor does ON Semiconductor assume any liability arising out of the application or use of any product or circuit, and specifically disclaims any and all liability, including without limitation special, consequential or incidental damages. Buyer is responsible for its products and applications using ON Semiconductor products, including compliance with all laws, regulations and safety requirements or standards, regardless of any support or applications information provided by ON Semiconductor. "Typical" parameters which may be provided in ON Semiconductor data sheets and/or specifications can and do vary in different applications and actual performance may vary over time. All operating parameters, including "Typicals" must be validated for each customer application by customer's technical experts. ON Semiconductor does not convey any license under its patent rights nor the rights of others. ON Semiconductor products are not designed, intended, or authorized for use as a critical component in life support systems or any FDA Class 3 medical devices or medical devices with a same or similar classification in a foreign jurisdiction or any devices intended for implantation in the human body. Should Buyer purchase or use ON Semiconductor products for any such unintended or unauthorized application, Buyer shall indemnify and hold ON Semiconductor and its officers, employees, subsidiaries, affiliates, and distributors harmless against all claims, costs, damages, and expenses, and reasonable attorney fees arising out of, directly or indirectly, any claim of personal injury or death associated with such unintended or unauthorized use, even if such claim alleges that ON Semiconductor was negligent regarding the design or manufacture of the part. ON Semiconductor is an Equal Opportunity/Affirmative Action Employer. This literature is subject to all applicable copyright laws and is not for resale in any manner.

### PUBLICATION ORDERING INFORMATION

LITERATURE FULFILLMENT:  
Email Requests to: [orderlit@onsemi.com](mailto:orderlit@onsemi.com)

TECHNICAL SUPPORT  
North American Technical Support:  
Voice Mail: 1 800-282-9855 Toll Free USA/Canada  
Phone: 011 421 33 790 2910

Europe, Middle East and Africa Technical Support:  
Phone: 00421 33 790 2910  
For additional information, please contact your local Sales Representative