

# AMC3330 Precision, $\pm 1$ -V Input, Reinforced Isolated Amplifier With Integrated DC/DC Converter

## 1 Features

- 3.3-V or 5-V single supply operation with integrated DC/DC converter
- $\pm 1$ -V input voltage range optimized for voltage measurements with high input impedance
- Fixed gain: 2.0
- Low DC errors:
  - Gain error:  $\pm 0.2\%$  (max)
  - Gain drift:  $\pm 45$  ppm/ $^{\circ}\text{C}$  (max)
  - Offset error:  $\pm 0.3$  mV (max)
  - Offset drift:  $\pm 4$   $\mu\text{V}/^{\circ}\text{C}$  (max)
  - Nonlinearity:  $\pm 0.02\%$  (max)
- High CMTI: 85 kV/ $\mu\text{s}$  (min)
- System-level diagnostic features
- Safety-related certifications:
  - 6000- $V_{\text{PK}}$  reinforced isolation per DIN VDE V 0884-11 (VDE V 0884-11): 2017-01
  - 4250- $V_{\text{RMS}}$  isolation for 1 minute per UL1577
- Meets CISPR-11 and CISPR-25 EMI standards

## 2 Applications

- Isolated voltage sensing in:
  - Motor drives
  - Photovoltaic inverters
  - Power delivery systems
  - Electricity meters
  - Protection relays

## 3 Description

The AMC3330 is a precision, isolated amplifier with a fully integrated, isolated DC/DC converter that allows single-supply operation from the low-side of the device. The reinforced capacitive isolation barrier is certified according to VDE V 0884-11 and UL1577 and separates sections of the system that operate on different common-mode voltage levels and protects low-voltage domains from damage.

The input of the AMC3330 is optimized for direct connection to high-impedance, voltage-signal sources such as a resistor-divider network to sense high-voltage signals. The integrated isolated DC/DC converter allows measurement of non-ground-referenced signals and makes the device a unique solution for noisy, space-constrained applications.

The excellent performance of the device supports accurate voltage monitoring and control. The integrated DC/DC converter fault-detection and diagnostic output pin of the AMC3330 simplify system-level design and diagnostics.

The AMC3330 is specified over the temperature range of  $-40^{\circ}\text{C}$  to  $+125^{\circ}\text{C}$ .

### Device Information (1)

PART NUMBER	PACKAGE	BODY SIZE (NOM)
AMC3330	SOIC (16)	10.30 mm $\times$ 7.50 mm

(1) For all available packages, see the orderable addendum at the end of the data sheet.

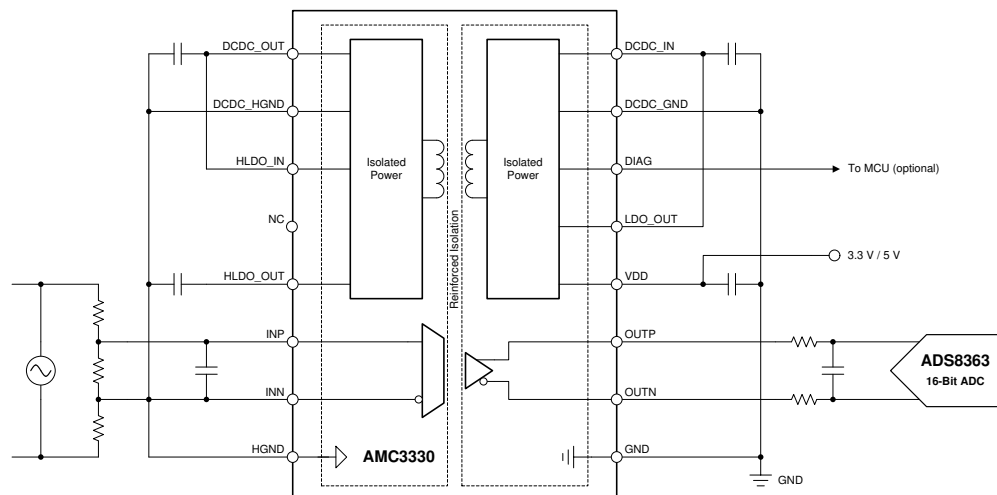

Application Example



## Table of Contents

<b>1 Features</b> .....	1	7.2 Functional Block Diagram.....	17
<b>2 Applications</b> .....	1	7.3 Feature Description.....	17
<b>3 Description</b> .....	1	7.4 Device Functional Modes.....	21
<b>4 Revision History</b> .....	2	<b>8 Application and Implementation</b> .....	22
<b>5 Pin Configuration and Functions</b> .....	3	8.1 Application Information.....	22
<b>6 Specifications</b> .....	4	8.2 Typical Application.....	22
6.1 Absolute Maximum Ratings .....	4	8.3 What to Do and What Not to Do.....	24
6.2 ESD Ratings .....	4	<b>9 Power Supply Recommendations</b> .....	25
6.3 Recommended Operating Conditions .....	4	<b>10 Layout</b> .....	27
6.4 Thermal Information .....	5	10.1 Layout Guidelines.....	27
6.5 Power Ratings .....	5	10.2 Layout Example.....	27
6.6 Insulation Specifications .....	6	<b>11 Device and Documentation Support</b> .....	28
6.7 Safety-Related Certifications .....	7	11.1 Device Support.....	28
6.8 Safety Limiting Values .....	7	11.2 Documentation Support.....	28
6.9 Electrical Characteristics .....	8	11.3 Receiving Notification of Documentation Updates..	28
6.10 Switching Characteristics .....	9	11.4 Support Resources.....	28
6.11 Timing Diagram.....	9	11.5 Trademarks.....	28
6.12 Insulation Characteristics Curves.....	10	11.6 Electrostatic Discharge Caution.....	28
6.13 Typical Characteristics.....	11	11.7 Glossary.....	28
<b>7 Detailed Description</b> .....	17	<b>12 Mechanical, Packaging, and Orderable Information</b> .....	28
7.1 Overview.....	17		

## 4 Revision History

NOTE: Page numbers for previous revisions may differ from page numbers in the current version.

Changes from Revision * (June 2020) to Revision A (October 2020)	Page
• Changed document status from advance information to production data.....	1

## 5 Pin Configuration and Functions

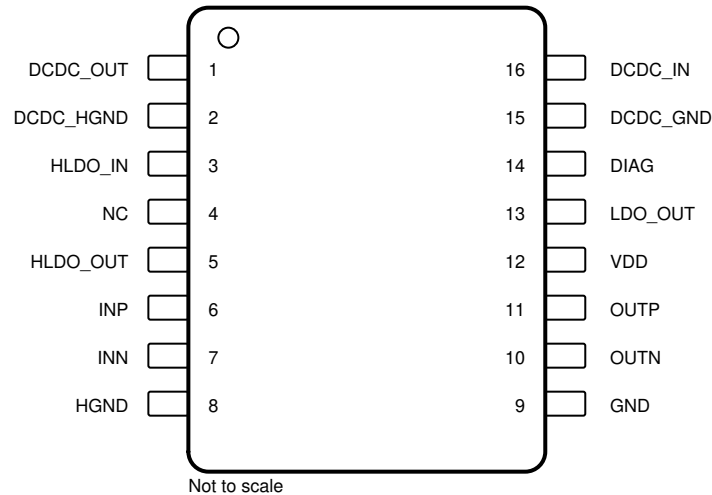

**Figure 5-1. DWE Package, 16-Pin SOIC, Top View**

**Table 5-1. Pin Functions**

PIN		TYPE	DESCRIPTION
NO.	NAME		
1	DCDC_OUT	Power	High-side output of the isolated DC/DC converter; connect this pin to the HLDO_IN pin. <sup>(1)</sup>
2	DCDC_HGND	Power Ground	High-side ground reference for the isolated DC/DC converter; connect this pin to the HGND pin.
3	HLDO_IN	Power	Input of the high-side low-dropout (LDO) regulator; connect this pin to the DCDC_OUT pin. <sup>(1)</sup>
4	NC	—	No internal connection. Connect this pin to the high-side ground or leave this pin unconnected (floating).
5	HLDO_OUT	Power	Output of the high-side LDO. <sup>(1)</sup>
6	INP	Analog Input	Noninverting analog input.
7	INN	Analog Input	Inverting analog input. Connect this pin to HGND.
8	HGND	Signal Ground	High-side analog ground; connect this pin to the DCDC_HGND pin.
9	GND	Signal Ground	Low-side analog ground; connect this pin to the DCDC_GND pin.
10	OUTN	Analog Output	Inverting analog output.
11	OUTP	Analog Output	Noninverting analog output.
12	VDD	Power	Low-side power supply. <sup>(1)</sup>
13	LDO_OUT	Power	Output of the low-side LDO; connect this pin to the DCDC_IN pin. <sup>(1)</sup>
14	DIAG	Digital Output	Active-low, open-drain status indicator output; connect this pin to the pullup supply (for example, VDD) using a resistor or leave this pin floating if not used.
15	DCDC_GND	Power Ground	Low-side ground reference for the isolated DC/DC converter; connect this pin to the GND pin.
16	DCDC_IN	Power	Low-side input of the isolated DC/DC converter; connect this pin to the LDO_OUT pin. <sup>(1)</sup>

(1) See the [Power Supply Recommendations](#) section for power-supply decoupling recommendations.

## 6 Specifications

### 6.1 Absolute Maximum Ratings

see (1)

		MIN	MAX	UNIT
Power-supply voltage	VDD to GND	-0.3	6.5	V
Analog input voltage	INP, INN	HGND – 6	$V_{HLD0out} + 0.5$	V
Analog output voltage	OUTP, OUTN	GND – 0.5	VDD + 0.5	V
Digital output voltage	DIAG	GND – 0.5	5.5	V
Input current	Continuous, any pin except power-supply pins	-10	10	mA
Temperature	Junction, $T_J$		150	°C
	Storage, $T_{stg}$	-65	150	

- (1) Stresses beyond those listed under *Absolute Maximum Ratings* may cause permanent damage to the device. These are stress ratings only, and do not imply functional operation of the device at these or any other conditions beyond those indicated under *Recommended Operating Conditions*. Exposure to absolute-maximum-rated conditions for extended periods may affect device reliability.

### 6.2 ESD Ratings

			VALUE	UNIT
$V_{(ESD)}$	Electrostatic discharge	Human-body model (HBM), per ANSI/ESDA/JEDEC JS-001(1)	±2000	V
		Charged-device model (CDM), per JEDEC specification JESD22-C101(2)	±1000	

- (1) JEDEC document JEP155 states that 500-V HBM allows safe manufacturing with a standard ESD control process.  
 (2) JEDEC document JEP157 states that 250-V CDM allows safe manufacturing with a standard ESD control process.

### 6.3 Recommended Operating Conditions

over operating ambient temperature range (unless otherwise noted)

			MIN	NOM	MAX	UNIT
<b>POWER SUPPLY</b>						
VDD	Low-side supply voltage	VDD to GND	3.0	3.3	5.5	V
<b>ANALOG INPUT</b>						
$V_{Clipping}$	Differential input voltage before clipping output	$V_{IN} = V_{INP} - V_{INN}$	±1.25			V
$V_{FSR}$	Specified linear differential full-scale voltage	$V_{IN} = V_{INP} - V_{INN}$	-1		1	V
	Absolute common-mode input voltage(1)	$(V_{INP} + V_{INN}) / 2$ to HGND	-2		3	V
$V_{CM}$	Operating common-mode input voltage	$(V_{INP} + V_{INN}) / 2$ to HGND, $V_{INP} = V_{INN}$	-1.4		1.6	V
		$(V_{INP} + V_{INN}) / 2$ to HGND, $ V_{INP} - V_{INN}  = 1.0$ V (2)	-0.925		0.725	
		$(V_{INP} + V_{INN}) / 2$ to HGND, $ V_{INP} - V_{INN}  = 1.25$ V	-0.8		0.6	
<b>DIGITAL OUTPUT</b>						
	Pull-up supply-voltage for DIAG pin		0		VDD	V
<b>TEMPERATURE RANGE</b>						
$T_A$	Operating ambient temperature		-40	25	125	°C

- (1) Steady-state voltage supported by the device in case of a system failure. See specified common-mode input voltage  $V_{CM}$  for normal operation. Observe analog input voltage range as specified in the *Absolute Maximum Ratings* table.  
 (2) Linear response.

## 6.4 Thermal Information

THERMAL METRIC <sup>(1)</sup>		AMC3330	UNIT
		DWE (SOIC)	
		16 PINS	
$R_{\theta JA}$	Junction-to-ambient thermal resistance	73.5	°C/W
$R_{\theta JC(top)}$	Junction-to-case (top) thermal resistance	31	°C/W
$R_{\theta JB}$	Junction-to-board thermal resistance	44	°C/W
$\Psi_{JT}$	Junction-to-top characterization parameter	16.7	°C/W
$\Psi_{JB}$	Junction-to-board characterization parameter	42.8	°C/W
$R_{\theta JC(bot)}$	Junction-to-case (bottom) thermal resistance	n/a	°C/W

(1) For more information about traditional and new thermal metrics, see the [Semiconductor and IC Package Thermal Metrics](#) application report.

## 6.5 Power Ratings

PARAMETER		TEST CONDITIONS	MIN	TYP	MAX	UNIT
$P_D$	Maximum power dissipation	VDD = 5.5 V			236.5	mW
		VDD = 3.6 V			155	

## 6.6 Insulation Specifications

over operating ambient temperature range (unless otherwise noted)

PARAMETER		TEST CONDITIONS	VALUE	UNIT
<b>GENERAL</b>				
CLR	External clearance <sup>(1)</sup>	Shortest pin-to-pin distance through air	≥ 8	mm
CPG	External creepage <sup>(1)</sup>	Shortest pin-to-pin distance across the package surface	≥ 8	mm
DTI	Distance through the insulation	Minimum internal gap (internal clearance - capacitive signal isolation)	≥ 21	μm
		Minimum internal gap (internal clearance - transformer power isolation)	≥ 120	
CTI	Comparative tracking index	DIN EN 60112 (VDE 0303-11); IEC 60112	≥ 600	V
	Material group	According to IEC 60664-1	I	
	Overvoltage category per IEC 60664-1	Rated mains voltage ≤ 600 V <sub>RMS</sub>	I-IV	
		Rated mains voltage ≤ 1000 V <sub>RMS</sub>	I-III	
<b>DIN VDE V 0884-11 (VDE V 0884-11): 2017-01<sup>(2)</sup></b>				
V <sub>IORM</sub>	Maximum repetitive peak isolation voltage	At AC voltage (bipolar)	1700	V <sub>PK</sub>
V <sub>IOWM</sub>	Maximum-rated isolation working voltage	At AC voltage (sine wave); time-dependent dielectric breakdown (TDDB) test	1200	V <sub>RMS</sub>
		At DC voltage	1700	V <sub>DC</sub>
V <sub>IOTM</sub>	Maximum transient isolation voltage	V <sub>TEST</sub> = V <sub>IOTM</sub> , t = 60 s (qualification test)	6000	V <sub>PK</sub>
		V <sub>TEST</sub> = 1.2 × V <sub>IOTM</sub> , t = 1 s (100% production test)	7200	V <sub>PK</sub>
V <sub>IOSM</sub>	Maximum surge isolation voltage <sup>(3)</sup>	Test method per IEC 60065, 1.2/50-μs waveform, V <sub>TEST</sub> = 1.6 × V <sub>IOSM</sub> = 10000 V <sub>PK</sub> (qualification)	6250	V <sub>PK</sub>
q <sub>pd</sub>	Apparent charge <sup>(4)</sup>	Method a, after input/output safety test subgroup 2 / 3, V <sub>ini</sub> = V <sub>IOTM</sub> , t <sub>ini</sub> = 60 s, V <sub>pd(m)</sub> = 1.2 × V <sub>IORM</sub> , t <sub>m</sub> = 10 s	≤ 5	pC
		Method a, after environmental tests subgroup 1, V <sub>ini</sub> = V <sub>IOTM</sub> , t <sub>ini</sub> = 60 s, V <sub>pd(m)</sub> = 1.6 × V <sub>IORM</sub> , t <sub>m</sub> = 10 s	≤ 5	
		Method b1, at routine test (100% production) and preconditioning (type test), V <sub>ini</sub> = V <sub>IOTM</sub> , t <sub>ini</sub> = 1 s, V <sub>pd(m)</sub> = 1.875 × V <sub>IORM</sub> , t <sub>m</sub> = 1 s	≤ 5	
C <sub>IO</sub>	Barrier capacitance, input to output <sup>(5)</sup>	V <sub>IO</sub> = 0.5 V <sub>PP</sub> at 1 MHz	~3.5	pF
R <sub>IO</sub>	Insulation resistance, input to output <sup>(5)</sup>	V <sub>IO</sub> = 500 V at T <sub>A</sub> = 25°C	> 10 <sup>12</sup>	Ω
		V <sub>IO</sub> = 500 V at 100°C ≤ T <sub>A</sub> ≤ 125°C	> 10 <sup>11</sup>	
		V <sub>IO</sub> = 500 V at T <sub>S</sub> = 150°C	> 10 <sup>9</sup>	
	Pollution degree		2	
	Climatic category		40/125/21	
<b>UL1577</b>				
V <sub>ISO</sub>	Withstand isolation voltage	V <sub>TEST</sub> = V <sub>ISO</sub> = 5000 V <sub>RMS</sub> or 7071 V <sub>DC</sub> , t = 60 s (qualification), V <sub>TEST</sub> = 1.2 × V <sub>ISO</sub> , t = 1 s (100% production test)	4250	V <sub>RMS</sub>

- (1) Apply creepage and clearance requirements according to the specific equipment isolation standards of an application. Care must be taken to maintain the creepage and clearance distance of a board design to ensure that the mounting pads of the isolator on the printed circuit board (PCB) do not reduce this distance. Creepage and clearance on a PCB become equal in certain cases. Techniques such as inserting grooves, ribs, or both on a PCB are used to help increase these specifications.
- (2) This coupler is suitable for *safe electrical insulation* only within the safety ratings. Compliance with the safety ratings must be ensured by means of suitable protective circuits.
- (3) Testing is carried out in air or oil to determine the intrinsic surge immunity of the isolation barrier.
- (4) Apparent charge is electrical discharge caused by a partial discharge (pd).
- (5) All pins on each side of the barrier are tied together, creating a two-pin device.

## 6.7 Safety-Related Certifications

VDE	UL
Certified according to DIN VDE V 0884-11 (VDE V 0884-11): 2017-01, DIN EN 60950-1 (VDE 0805 Teil 1): 2014-08, and DIN EN 60065 (VDE 0860): 2005-11	Recognized under 1577 component recognition and CSA component acceptance NO 5 programs
Reinforced insulation	Single protection
Certificate number: 40040142	File number: E181974

## 6.8 Safety Limiting Values

Safety limiting <sup>(1)</sup> intends to minimize potential damage to the isolation barrier upon failure of input or output circuitry. A failure of the I/O can allow low resistance to ground or the supply and, without current limiting, dissipate sufficient power to over-heat the die and damage the isolation barrier potentially leading to secondary system failures.

PARAMETER		TEST CONDITIONS	MIN	TYP	MAX	UNIT
I <sub>S</sub>	Safety input, output, or supply current	R <sub>θJA</sub> = 73.5°C/W, VDD = 5.5 V, T <sub>J</sub> = 150°C, T <sub>A</sub> = 25°C			309	mA
		R <sub>θJA</sub> = 73.5°C/W, VDD = 3.6 V, T <sub>J</sub> = 150°C, T <sub>A</sub> = 25°C			472	
P <sub>S</sub>	Safety input, output, or total power	R <sub>θJA</sub> = 73.5°C/W, T <sub>J</sub> = 150°C, T <sub>A</sub> = 25°C			1700	mW
T <sub>S</sub>	Maximum safety temperature				150	°C

- (1) The maximum safety temperature, T<sub>S</sub>, has the same value as the maximum junction temperature, T<sub>J</sub>, specified for the device. The I<sub>S</sub> and P<sub>S</sub> parameters represent the safety current and safety power, respectively. Do not exceed the maximum limits of I<sub>S</sub> and P<sub>S</sub>. These limits vary with the ambient temperature, T<sub>A</sub>.

The junction-to-air thermal resistance, R<sub>θJA</sub>, in the [Thermal Information](#) table is that of a device installed on a high-K test board for leaded surface-mount packages. Use these equations to calculate the value for each parameter:

$T_J = T_A + R_{\theta JA} \times P$ , where P is the power dissipated in the device.

$T_{J(max)} = T_S = T_A + R_{\theta JA} \times P_S$ , where T<sub>J(max)</sub> is the maximum junction temperature.

$P_S = I_S \times VDD_{max}$ , where VDD<sub>max</sub> is the maximum low-side voltage.

## 6.9 Electrical Characteristics

minimum and maximum specifications apply from  $T_A = -40^\circ\text{C}$  to  $+125^\circ\text{C}$ ,  $V_{DD} = 3.0\text{ V}$  to  $5.5\text{ V}$ ,  $I_{NP} = -1\text{ V}$  to  $+1\text{ V}$ , and  $I_{NN} = \text{HGND} = 0\text{ V}$ ; typical specifications are at  $T_A = 25^\circ\text{C}$ , and  $V_{DD} = 3.3\text{ V}$  (unless otherwise noted)

PARAMETER		TEST CONDITIONS	MIN	TYP	MAX	UNIT
<b>ANALOG INPUT</b>						
$R_{IN}$	Single-ended input resistance	$I_{NN} = \text{HGND}$	0.1	0.8		G $\Omega$
$R_{IND}$	Differential input resistance		0.1	1.2		
$I_{IB}$	Input bias current	$I_{NP} = I_{NN} = \text{HGND}$ , $I_{IB} = (I_{IBP} + I_{IBN}) / 2$	-10	2.5	10	nA
$TC_{IB}$	Input bias current drift			-14		pA/ $^\circ\text{C}$
$I_{IO}$	Input offset current	$I_{IO} = I_{INP} - I_{INN}$ ; $I_{NP} = I_{NN} = \text{HGND}$	-10	-0.8	10	nA
$C_{IN}$	Single-ended input capacitance	$I_{NN} = \text{HGND}$ , $f_{IN} = 310\text{ kHz}$		2		pF
$C_{IND}$	Differential input capacitance	$f_{IN} = 310\text{ kHz}$		2		
<b>ANALOG OUTPUT</b>						
	Nominal gain			2		
$V_{CMout}$	Common-mode output voltage		1.39	1.44	1.49	V
$V_{CLIPout}$	Clipping differential output voltage	$V_{OUT} = (V_{OUTP} - V_{OUTN})$ ; $ V_{IN}  =  V_{INP} - V_{INN}  > V_{Clipping}$		$\pm 2.49$		V
$V_{Failsafe}$	Fail-safe differential output voltage	$V_+ = (V_{OUTP} - V_{OUTN})$ ; $V_{DCDCout} \leq V_{DCDCUV}$ or $V_{HLDout} \leq V_{HLDOUTV}$		-2.57	-2.5	V
$BW_{OUT}$	Output bandwidth		300	375		kHz
$R_{OUT}$	Output resistance	On OUTP or OUTN		0.2		$\Omega$
	Output short-circuit current	On OUTP or OUTN, sourcing or sinking, $I_{NP} = I_{NN} = \text{HGND}$ , outputs shorted to either GND or VDD		14		mA
$CMTI$	Common-mode transient immunity	$ HGND - GND  = 2\text{ kV}$	85	135		kV/ $\mu\text{s}$
<b>ACCURACY</b>						
$E_G$	Gain error	$T_A = 25^\circ\text{C}$	-0.2%	-0.08%	0.2%	
$TCE_G$	Gain error drift <sup>(1)</sup>		-45	$\pm 7$	45	ppm/ $^\circ\text{C}$
$V_{OS}$	Input offset voltage <sup>(1)</sup>	$T_A = 25^\circ\text{C}$ , $I_{NP} = I_{NN} = \text{HGND}$	-0.3	$\pm 0.05$	0.3	mV
$TCV_{OS}$	Input offset drift <sup>(1)</sup>		-4	$\pm 1$	4	$\mu\text{V}/^\circ\text{C}$
	Nonlinearity		-0.02%	0.01%	0.02%	
	Nonlinearity drift			0.4		ppm/ $^\circ\text{C}$
SNR	Signal-to-noise ratio	$V_{IN} = 2\text{ V}_{PP}$ , $f_{IN} = 1\text{ kHz}$ , $BW = 10\text{ kHz}$ , 10 kHz filter	81	85		dB
		$V_{IN} = 2\text{ V}_{PP}$ , $f_{IN} = 10\text{ kHz}$ , $BW = 100\text{ kHz}$ , 1 MHz filter		72		
THD	Total harmonic distortion	$V_{IN} = 2\text{ V}_{PP}$ , $f_{IN} = 10\text{ kHz}$ , $BW = 100\text{ kHz}$		-84		dB
	Output noise	$I_{NP} = I_{NN} = \text{HGND}$ , $f_{IN} = 0\text{ Hz}$ , $BW = 100\text{ kHz}$		250		$\mu\text{V}_{RMS}$
CMRR	Common-mode rejection ratio	$f_{IN} = 0\text{ Hz}$ , $V_{CM\ min} \leq V_{CM} \leq V_{CM\ max}$		-100		dB
		$f_{IN} = 10\text{ kHz}$ , $V_{CM\ min} \leq V_{CM} \leq V_{CM\ max}$		-86		
PSRR	Power-supply rejection ratio	VDD from 3.0 V to 5.5 V, at dc, input referred		-98		dB
		$I_{NP} = I_{NN} = \text{HGND}$ , VDD from 3.0 V to 5.5 V, 10 kHz / 100 mV ripple, input referred		-86		



## 6.9 Electrical Characteristics (continued)

minimum and maximum specifications apply from  $T_A = -40^\circ\text{C}$  to  $+125^\circ\text{C}$ ,  $V_{DD} = 3.0\text{ V}$  to  $5.5\text{ V}$ ,  $I_{NP} = -1\text{ V}$  to  $+1\text{ V}$ , and  $I_{NN} = \text{HGND} = 0\text{ V}$ ; typical specifications are at  $T_A = 25^\circ\text{C}$ , and  $V_{DD} = 3.3\text{ V}$  (unless otherwise noted)

PARAMETER		TEST CONDITIONS	MIN	TYP	MAX	UNIT
<b>POWER SUPPLY</b>						
I <sub>DD</sub>	Low-side supply current	No external load on HLDO		28.5	41	mA
		1 mA external load on HLDO		30.5	43	mA
V <sub>DCDC_OUT</sub>	DC/DC output voltage	DCDC_OUT to HGND	3.1	3.5	4.65	V
V <sub>DCDCUV</sub>	DC/DC output undervoltage detection threshold voltage	DCDC output falling	2.1	2.25		V
V <sub>HLDO_OUT</sub>	High-side LDO output voltage	HLDO to HGND, up to 1 mA external load	3	3.2	3.4	V
V <sub>HLDOUV</sub>	High-side LDO output undervoltage detection threshold voltage	HLDO output falling	2.4	2.6		V
I <sub>H</sub>	High-side supply current for auxiliary circuitry	Load connected from HLDO_OUT to HGND; non-switching			1	mA
t <sub>AS</sub>	Analog settling time	V <sub>DD</sub> step to 3.0 V, to OUTP and OUTN valid, 0.1% settling		0.6	1.1	ms

(1) The typical value includes one standard deviation ("sigma") at nominal operating conditions.

## 6.10 Switching Characteristics

over operating ambient temperature range (unless otherwise noted)

PARAMETER		TEST CONDITIONS	MIN	TYP	MAX	UNIT
t <sub>r</sub>	Output signal rise time			1.3		μs
t <sub>f</sub>	Output signal fall time			1.3		μs
	V <sub>INx</sub> to V <sub>OUTx</sub> signal delay (50% – 10%)	Unfiltered output		1.2	1.3	μs
	V <sub>INx</sub> to V <sub>OUTx</sub> signal delay (50% – 50%)	Unfiltered output		1.6	2.1	μs
	V <sub>INx</sub> to V <sub>OUTx</sub> signal delay (50% – 90%)	Unfiltered output		2.2	2.6	μs

## 6.11 Timing Diagram

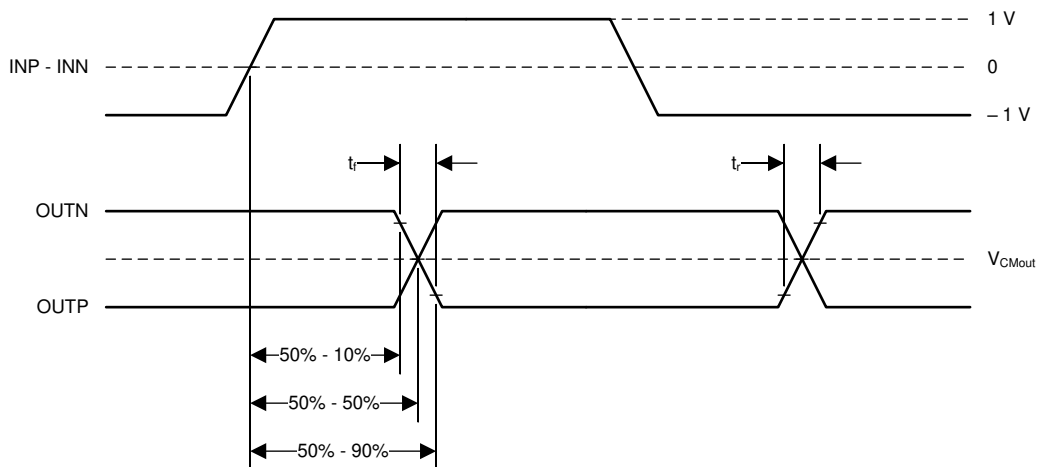
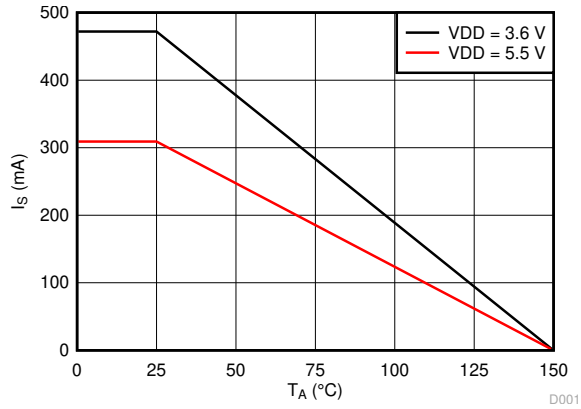
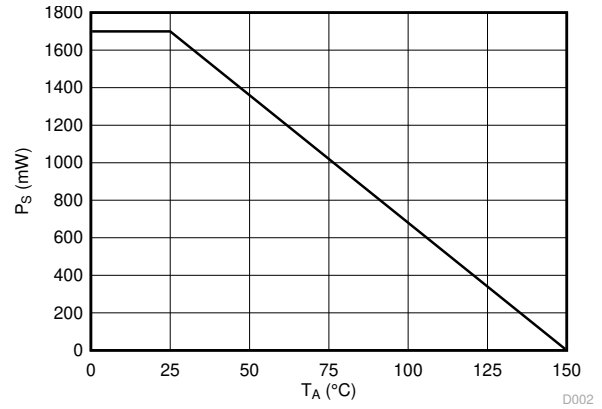

Figure 6-1. Rise, Fall, and Delay Time Waveforms

### 6.12 Insulation Characteristics Curves



**Figure 6-2. Thermal Derating Curve for Safety-Limiting Current per VDE**



**Figure 6-3. Thermal Derating Curve for Safety-Limiting Power per VDE**

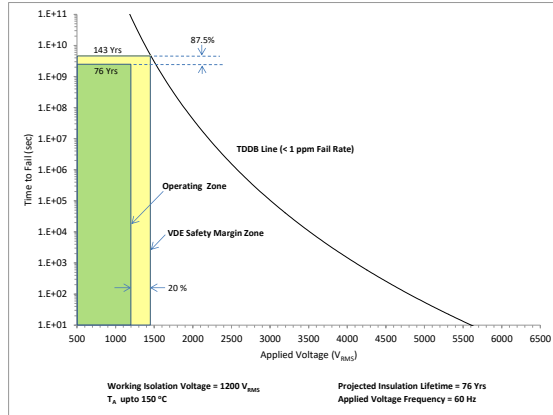

**Figure 6-4. Reinforced Isolation Capacitor Lifetime Projection**

### 6.13 Typical Characteristics

at VDD = 3.3 V, INP = -1 V to 1 V, INN = HGND = 0V, and  $f_{IN} = 10$  kHz (unless otherwise noted)

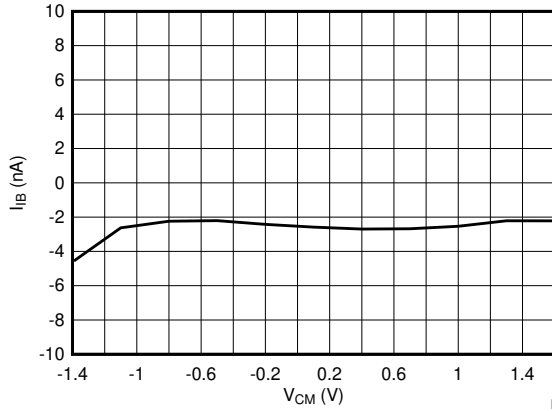

Figure 6-5. Input Bias Current vs Common-Mode Input Voltage

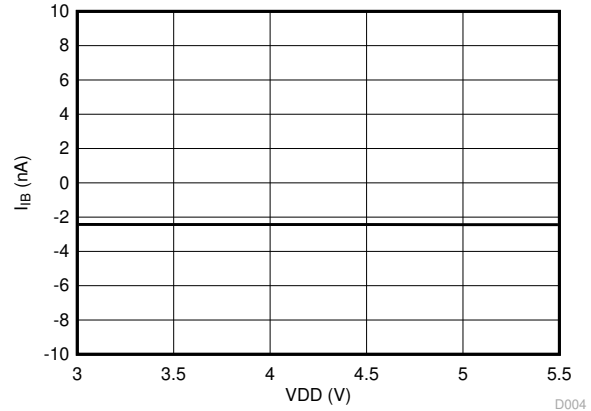

Figure 6-6. Input Bias Current vs Supply Voltage

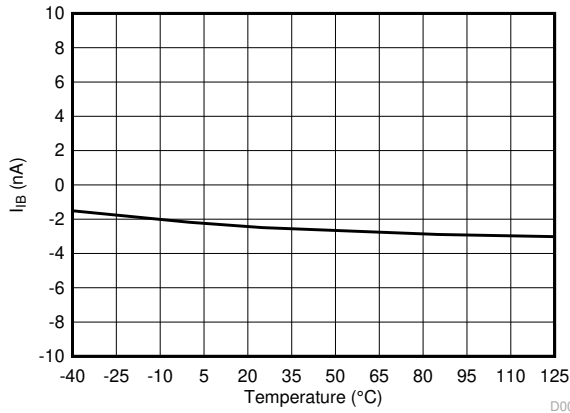

Figure 6-7. Input Bias Current vs Temperature

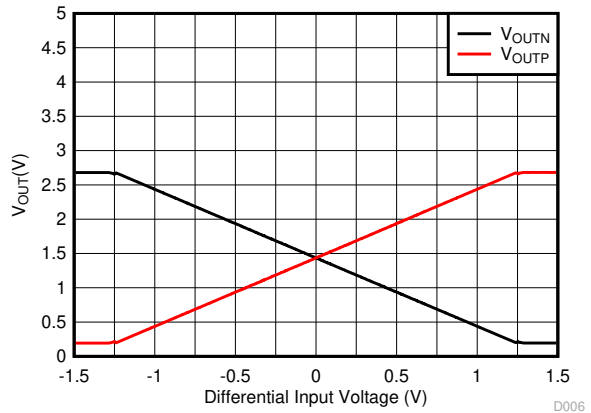

Figure 6-8. Output vs Differential Input Voltage

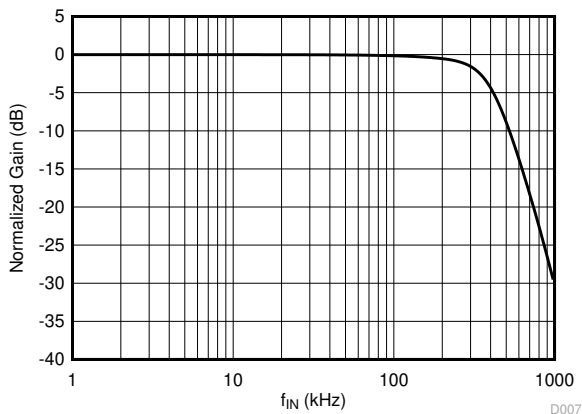

Figure 6-9. Normalized Gain vs Input Frequency

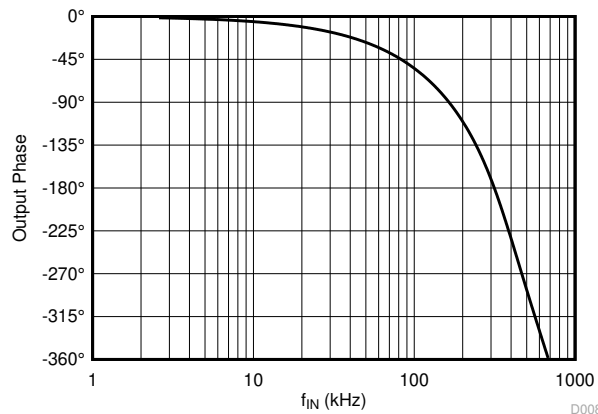

Figure 6-10. Output Phase vs Input Frequency

### 6.13 Typical Characteristics (continued)

at VDD = 3.3 V, INP = -1 V to 1 V, INN = HGND = 0V, and  $f_{IN} = 10$  kHz (unless otherwise noted)

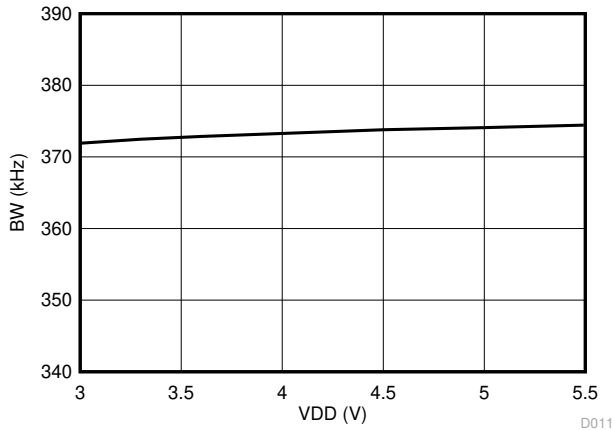

Figure 6-11. Output Bandwidth vs Supply Voltage

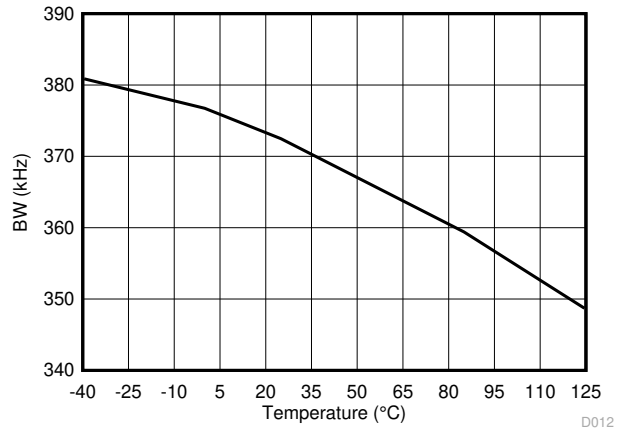

Figure 6-12. Output Bandwidth vs Temperature

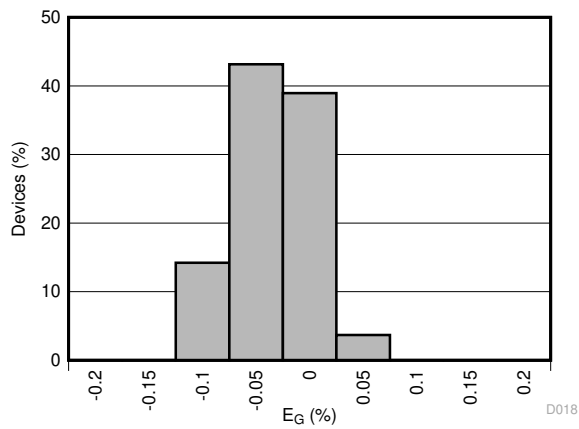

Figure 6-13. Gain Error Histogram

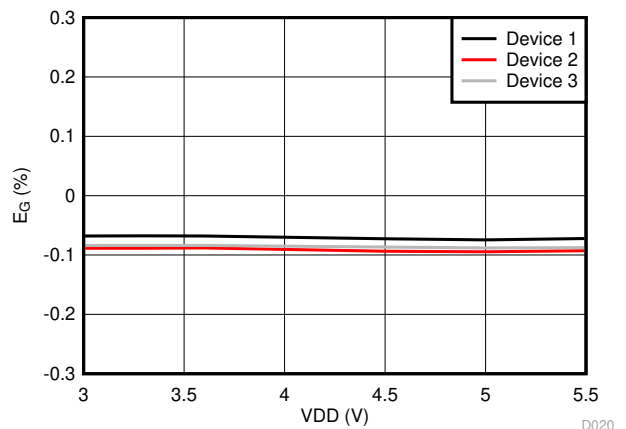

Figure 6-14. Gain Error vs Supply Voltage

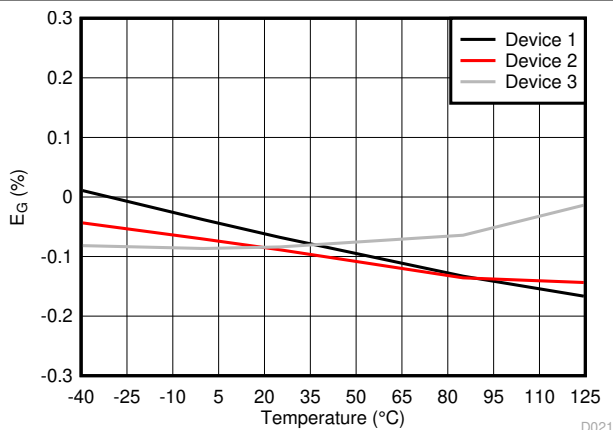

Figure 6-15. Gain Error vs Temperature

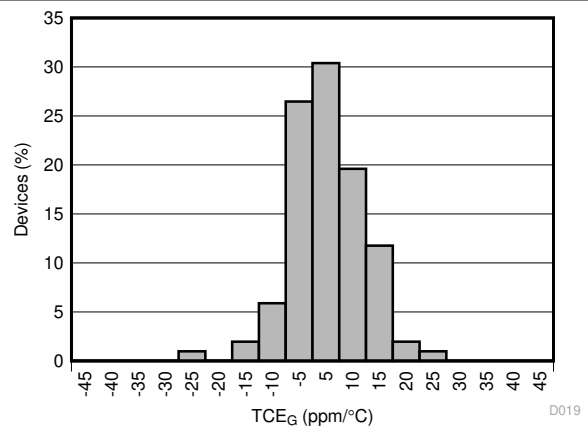

Figure 6-16. Gain Error Drift Histogram

### 6.13 Typical Characteristics (continued)

at VDD = 3.3 V, INP = -1 V to 1 V, INN = HGND = 0V, and  $f_{IN} = 10$  kHz (unless otherwise noted)

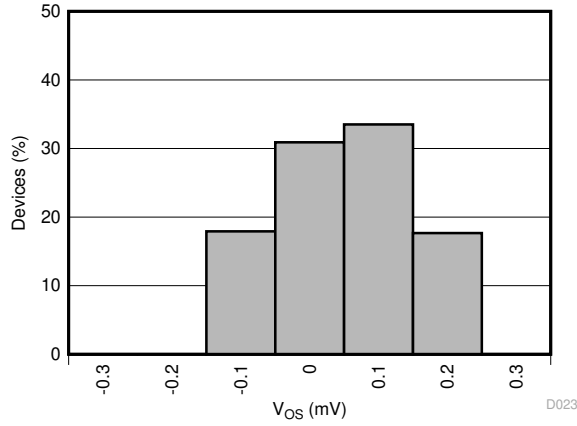

Figure 6-17. Offset Error Histogram

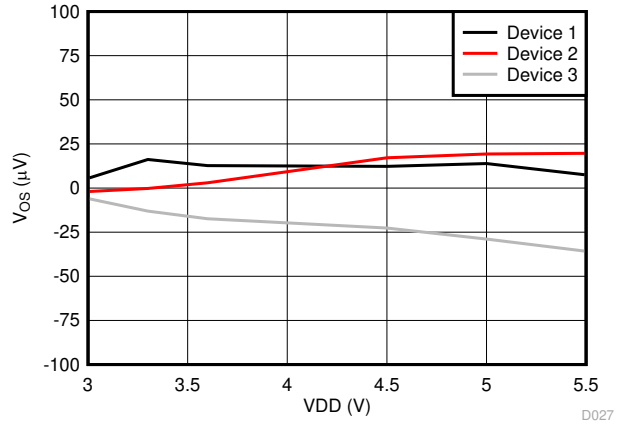

Figure 6-18. Offset Error vs Supply Voltage

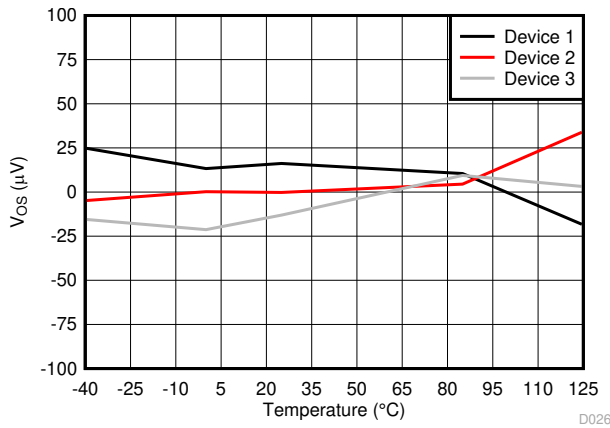

Figure 6-19. Offset Error vs Temperature

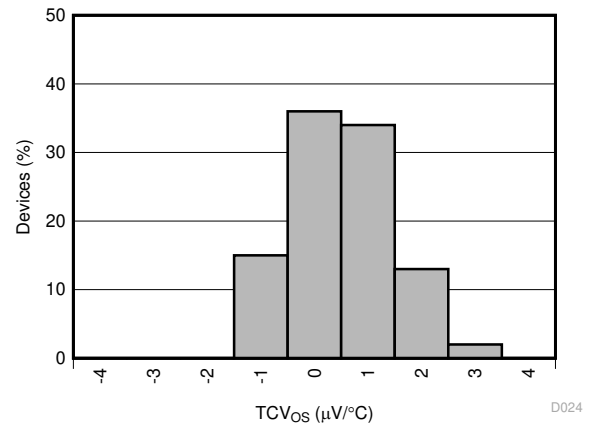

Figure 6-20. Offset Error Drift Histogram

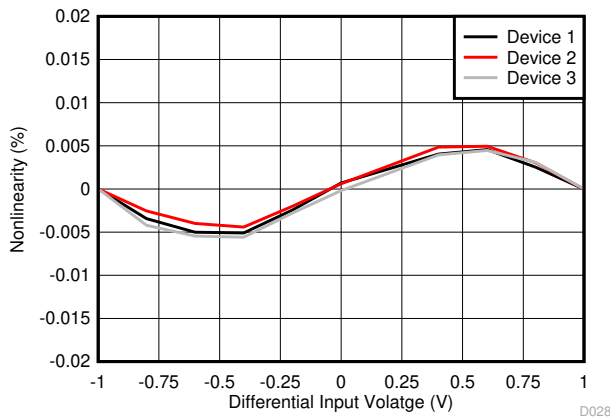

Figure 6-21. Nonlinearity vs Differential Input Voltage

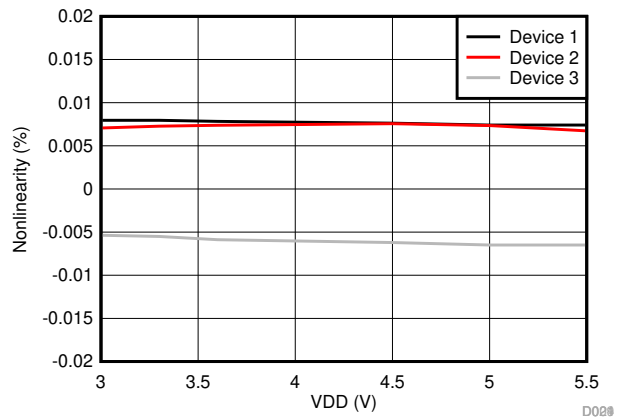

Figure 6-22. Nonlinearity vs Supply Voltage

### 6.13 Typical Characteristics (continued)

at VDD = 3.3 V, INP = -1 V to 1 V, INN = HGND = 0V, and  $f_{IN} = 10$  kHz (unless otherwise noted)

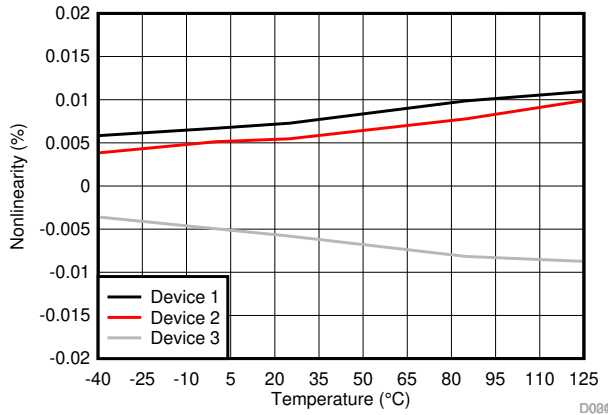

Figure 6-23. Nonlinearity vs Temperature

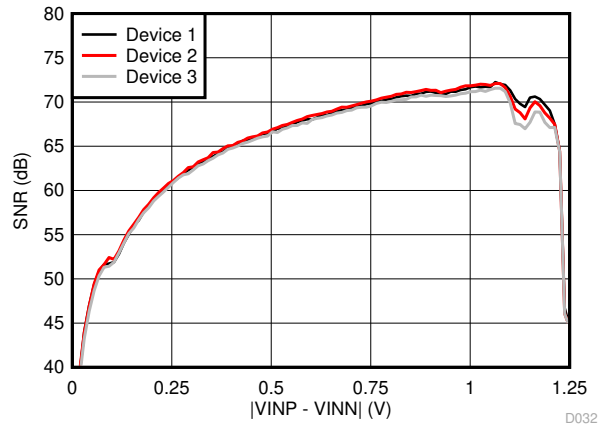

Figure 6-24. Signal to Noise Ratio vs Differential Input Voltage

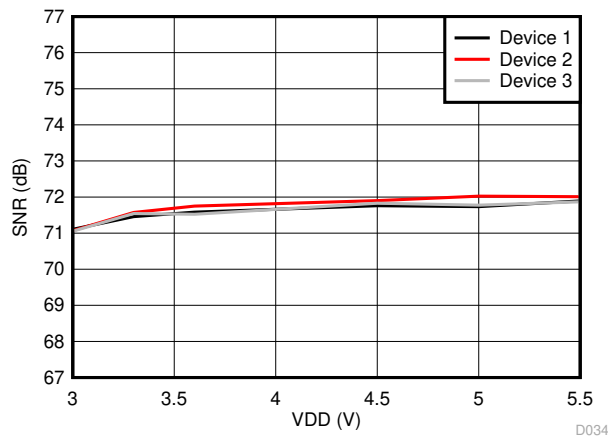

Figure 6-25. Signal to Noise Ratio vs Supply Voltage

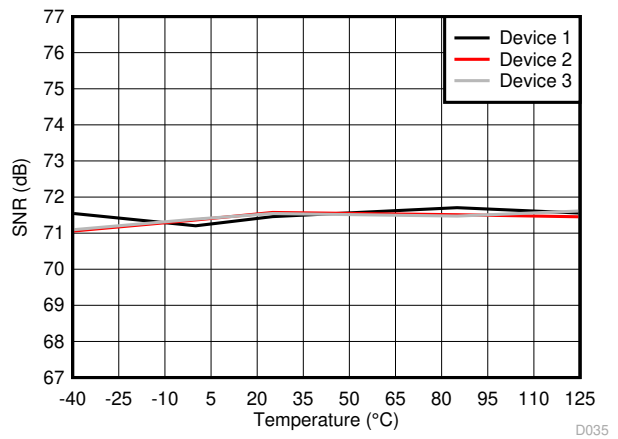

Figure 6-26. Signal to Noise Ratio vs Temperature

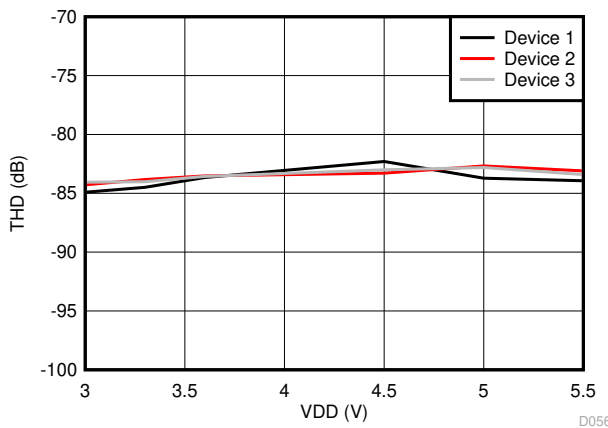

Figure 6-27. Total Harmonic Distortion vs Supply Voltage

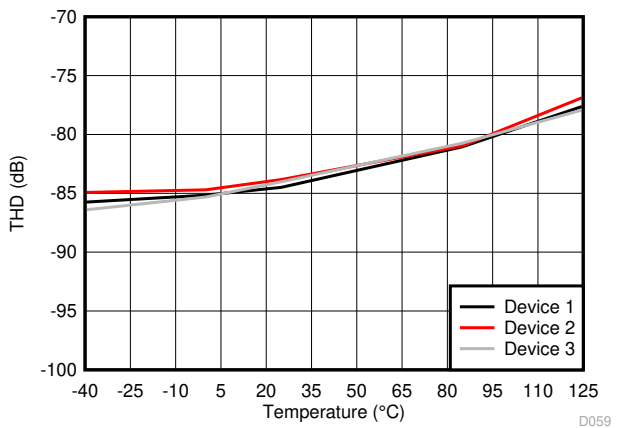

Figure 6-28. Total Harmonic Distortion vs Temperature

### 6.13 Typical Characteristics (continued)

at VDD = 3.3 V, INP = -1 V to 1 V, INN = HGND = 0V, and  $f_{IN} = 10$  kHz (unless otherwise noted)

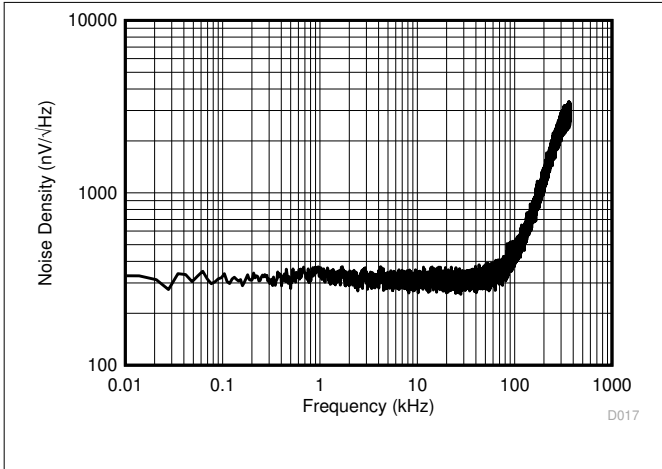

Figure 6-29. Input-Referred Noise Density vs Frequency

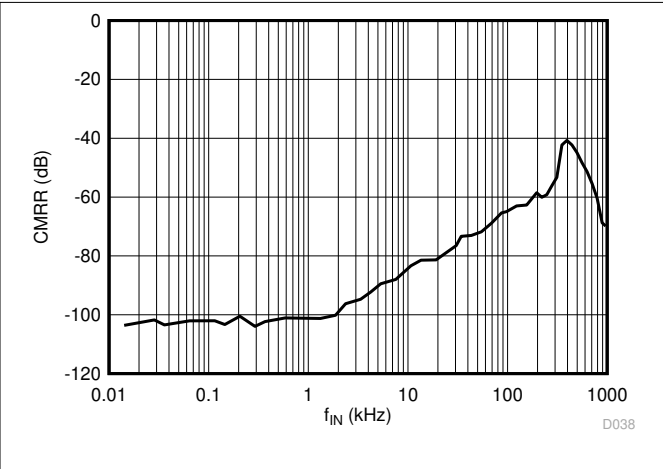

Figure 6-30. Common-Mode Rejection Ratio vs Input Frequency

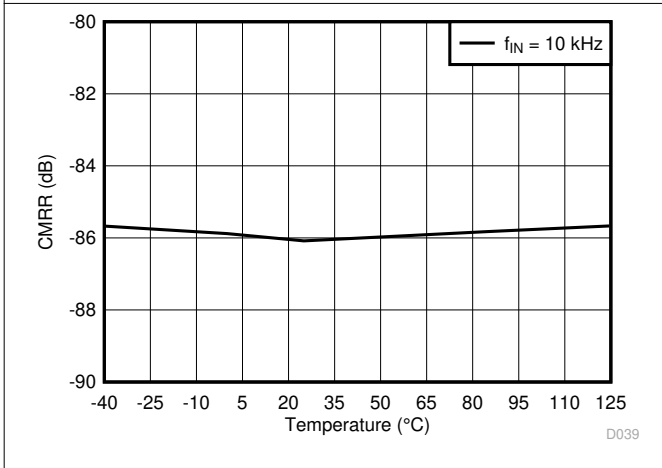

Figure 6-31. Common-Mode Rejection Ratio vs Temperature

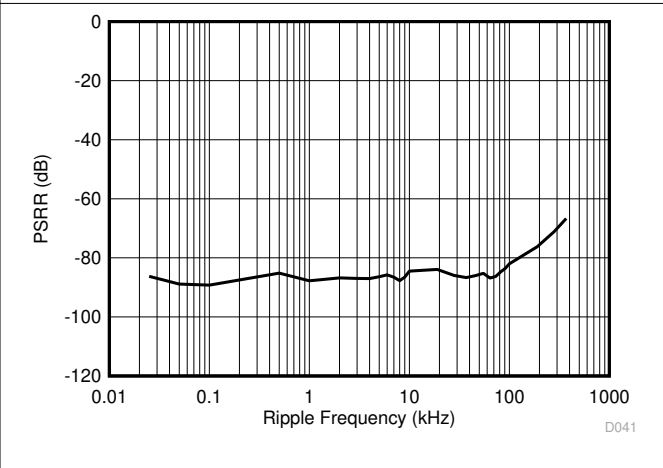

Figure 6-32. Power-Supply Rejection Ratio vs Ripple Frequency

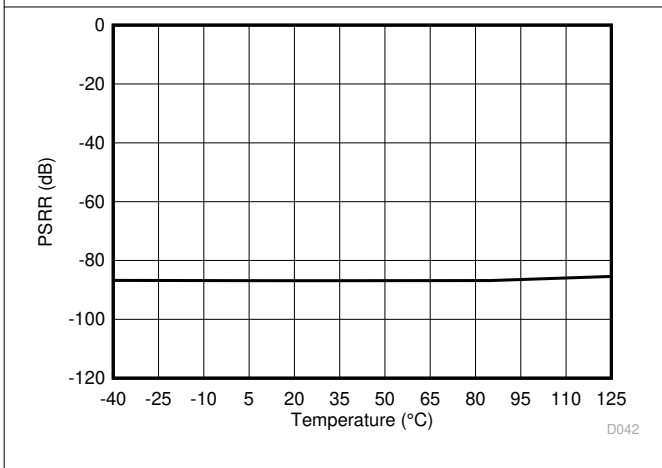

Figure 6-33. Power-Supply Rejection Ratio vs Temperature

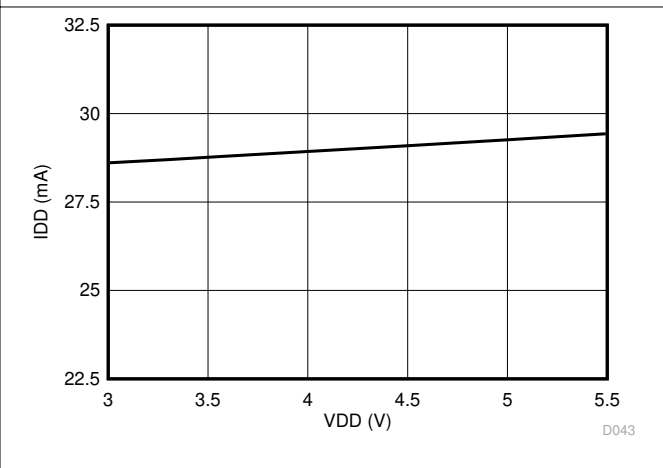

Figure 6-34. Input-Supply Current vs Supply Voltage

### 6.13 Typical Characteristics (continued)

at VDD = 3.3 V, INP = -1 V to 1 V, INN = HGND = 0V, and  $f_{IN} = 10$  kHz (unless otherwise noted)

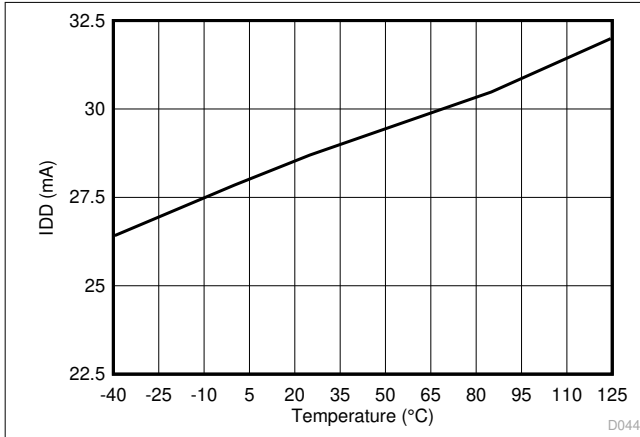

Figure 6-35. Input-Supply Current vs Temperature

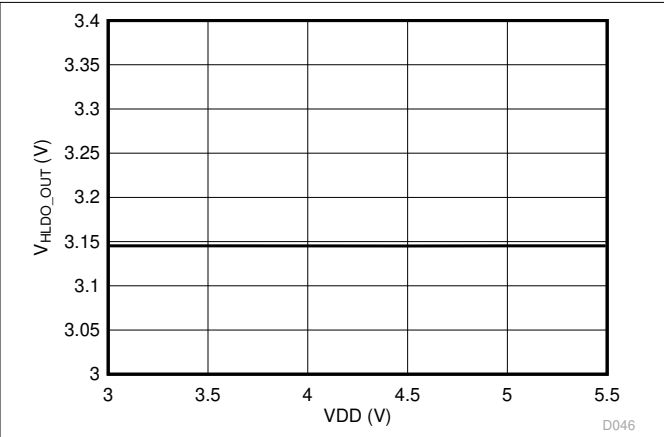

Figure 6-36. High-Side LDO Line Regulation

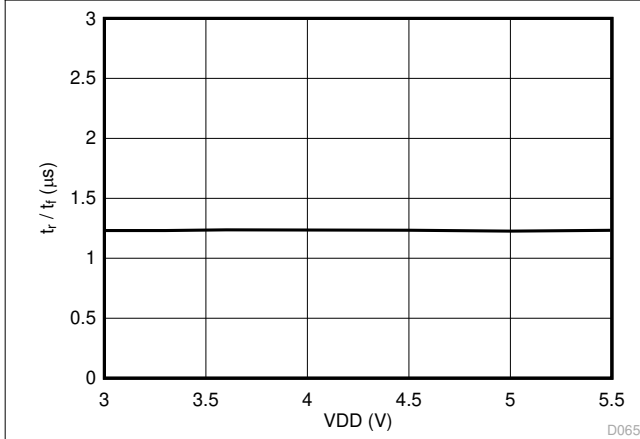

Figure 6-37. Output Rise And Fall Time vs Supply Voltage

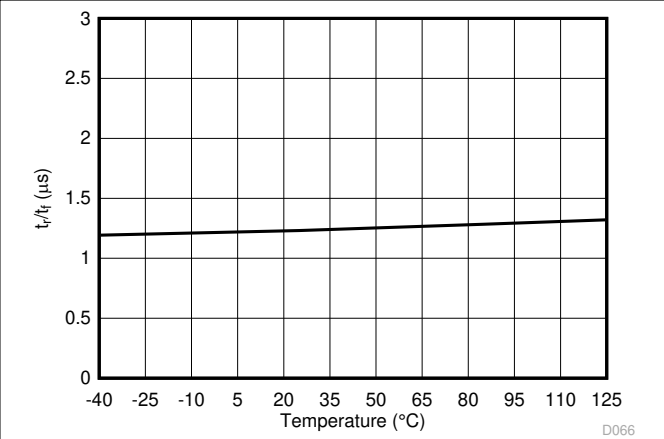

Figure 6-38. Output Rise And Fall Time vs Temperature

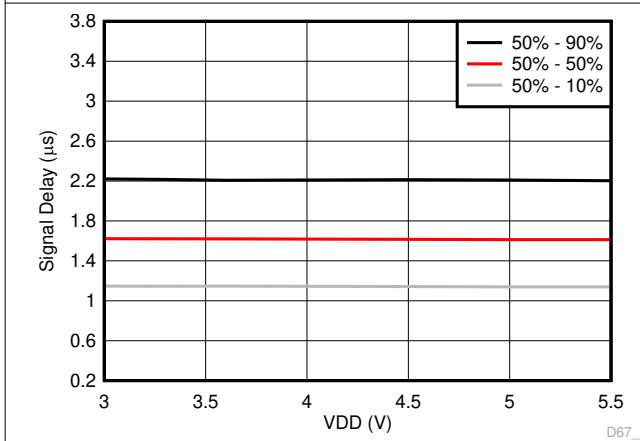

Figure 6-39.  $V_{IN}$  to  $V_{OUT}$  Signal Delay Time vs Supply Voltage

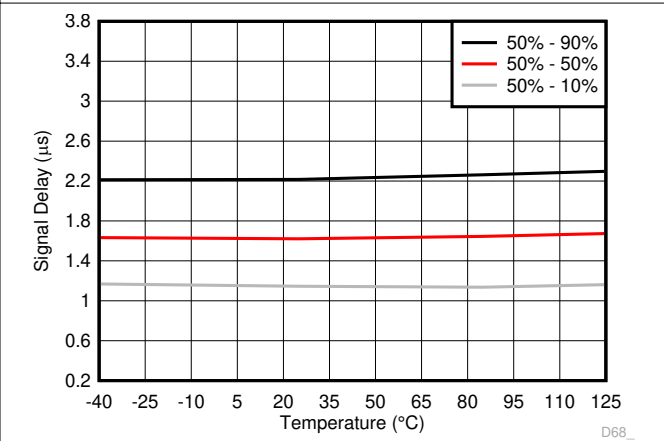

Figure 6-40.  $V_{IN}$  to  $V_{OUT}$  Signal Delay Time vs Temperature



## 7 Detailed Description

### 7.1 Overview

The AMC3330 is a fully-differential, precision, isolated amplifier with high input impedance, and an integrated DC/DC converter that allows the device to be supplied from a single 3.3-V or 5-V voltage supply source on the low side. The input stage of the device drives a second-order, delta-sigma ( $\Delta\Sigma$ ) modulator. The modulator uses an internal voltage reference and clock generator to convert the analog input signal to a digital bitstream. The drivers (termed TX in the *Functional Block Diagram*) transfer the output of the modulator across the isolation barrier that separates the high-side and low-side voltage domains. The received bitstream and clock are synchronized and processed by a fourth-order analog filter on the low-side and presented as a differential analog output.

A block diagram of the AMC3330 is shown in the *Functional Block Diagram*. The 1.2-G $\Omega$  differential input impedance of the analog input stage supports low gain-error signal-sensing in high-voltage applications using high-impedance resistor dividers.

The signal path is isolated by a double capacitive silicon-dioxide (SiO<sub>2</sub>) insulation barrier, whereas power isolation uses an on-chip transformer separated by a thin-film polymer as the insulating material.

### 7.2 Functional Block Diagram

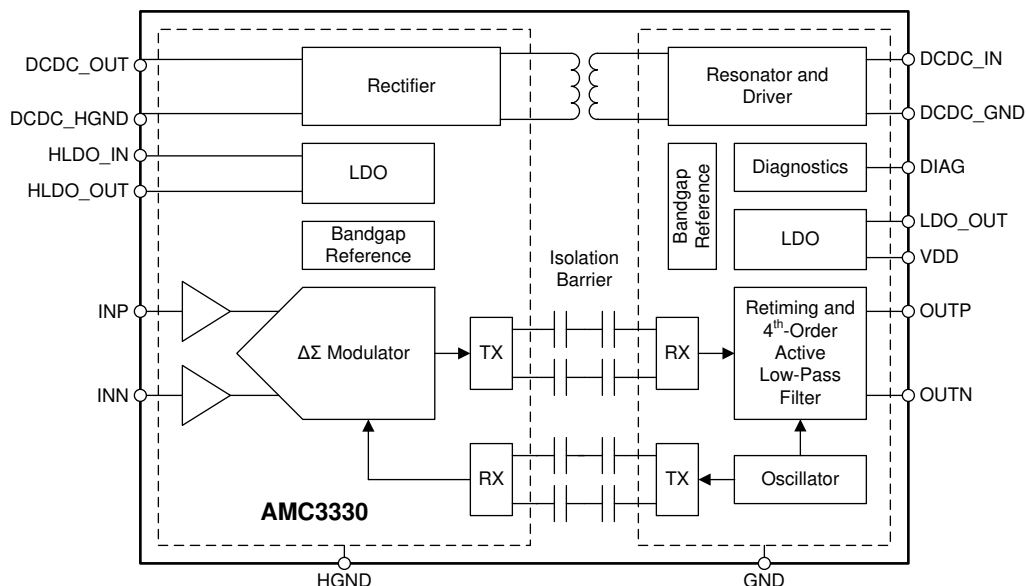

### 7.3 Feature Description

#### 7.3.1 Analog Input

The input stage of the AMC3330 feeds a second-order, switched-capacitor, feed-forward  $\Delta\Sigma$  modulator. The modulator converts the analog signal into a bitstream that is transferred over the isolation barrier, as described in the *Isolation Channel Signal Transmission* section. The high-impedance, and low bias-current input of the AMC3330 makes the device suitable for isolated, high-voltage-sensing applications that typically employ high-impedance resistor dividers.

There are two restrictions on the analog input signals (INP and INN). First, if the input voltage exceeds the input range specified in the *Absolute Maximum Ratings* table, the input current must be limited to 10 mA because the device input electrostatic discharge (ESD) diodes turn on. Second, the linearity and noise performance of the device are ensured only when the differential analog input voltage remains within the specified linear full-scale range  $V_{FSR}$  and within the specified input common-mode voltage range  $V_{CM}$  as specified in the *Recommended Operating Conditions* table.

### 7.3.2 Isolation Channel Signal Transmission

The AMC3330 uses an on-off keying (OOK) modulation scheme to transmit the modulator output-bitstream across the capacitive SiO<sub>2</sub>-based isolation barrier. Figure 7-1 shows the block diagram of an isolation channel. The transmitter modulates the bitstream at TX IN with an internally generated, 480-MHz carrier and sends a burst across the isolation barrier to represent a digital *one* and sends a *no signal* to represent the digital *zero*. The receiver demodulates the signal after advanced signal conditioning and produces the output. The symmetrical design of each isolation channel improves the common-mode transient immunity (CMTI) performance and reduces the radiated emissions caused by the high-frequency carrier.

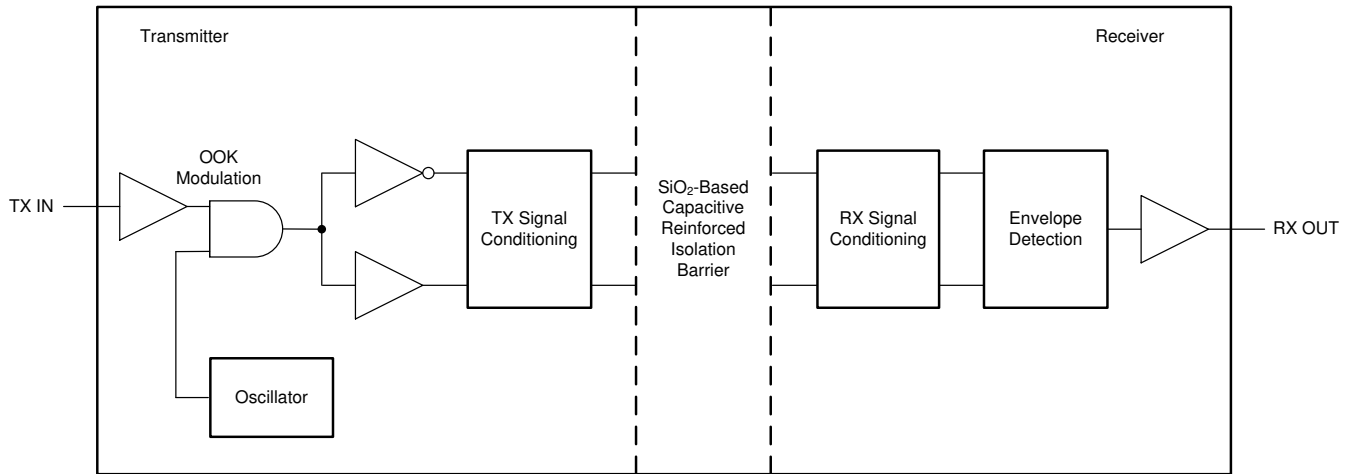

**Figure 7-1. Block Diagram of an Isolation Channel**

Figure 7-2 shows the concept of the on-off keying scheme.

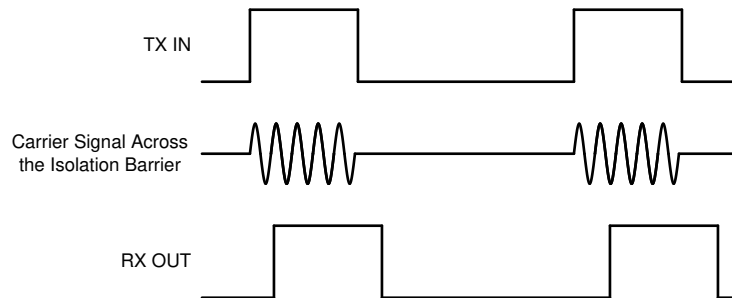

**Figure 7-2. OOK-Based Modulation Scheme**

### 7.3.3 Analog Output

The AMC3330 offers a differential analog output comprised of the OOUTP and OOUTN pins. For differential input voltages ( $V_{INP} - V_{INN}$ ) in the range from  $-1\text{ V}$  to  $1\text{ V}$ , the device provides a linear response with a nominal gain of 2. For example, for a differential input voltage of  $1\text{ V}$ , the differential output voltage ( $V_{OOUTP} - V_{OOUTN}$ ) is  $2\text{ V}$ . At zero input (INP shorted to INN), both pins output the same voltage,  $V_{CMout}$ , as specified in the [Electrical Characteristics](#) table. For absolute differential input voltages greater than  $1.0\text{ V}$  but less than  $1.25\text{ V}$ , the differential output voltage continues to increase in magnitude but with reduced linearity performance. The outputs saturate as shown in [Figure 7-3](#) if the differential input voltage exceeds the  $V_{Clipping}$  value.

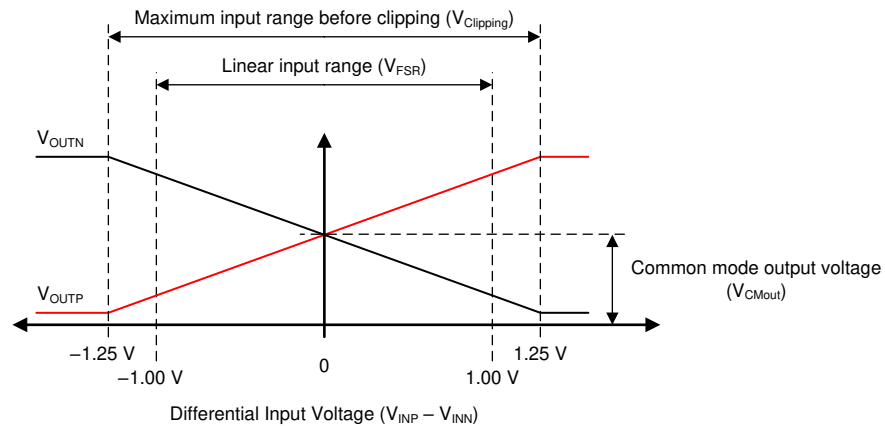

**Figure 7-3. AMC3330 Output Behavior**

The AMC3330 provides a fail-safe output that simplifies diagnostics on system level. The fail-safe output is active when the integrated DC/DC converter or high-side LDO don't deliver the required supply voltage for the high-side of the device. [Figure 7-4](#) and [Figure 7-5](#) illustrate the fail-safe output of the AMC3330 that is a negative differential output voltage value that does not occur under normal operating conditions. Use the maximum  $V_{FAILSAFE}$  voltage specified in the [Electrical Characteristics](#) table as a reference value for the fail-safe detection on system level.

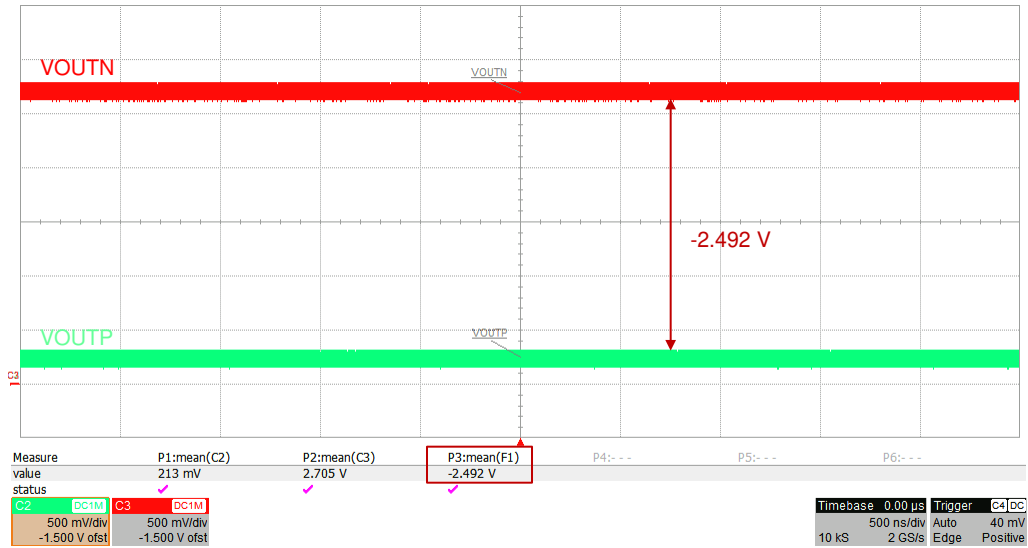

Figure 7-4. Typical Negative Clipping Output of the AMC3330



Figure 7-5. Typical Fail-Safe Output of the AMC3330

### 7.3.4 Isolated DC/DC Converter

The AMC3330 offers a fully integrated isolated DC/DC converter that includes the following components illustrated in the [Functional Block Diagram](#):

- Low-dropout regulator (LDO) on the low-side to stabilize the supply voltage VDD that drives the low-side of the DC/DC converter
- Low-side full-bridge inverter and drivers
- Laminate-based, air-core transformer for high immunity to magnetic fields
- High-side full-bridge rectifier
- High-side LDO to stabilize the output voltage of the DC/DC converter for high analog performance of the signal path

The DC/DC converter uses a spread-spectrum clock generation technique to reduce the spectral density of the electromagnetic radiation. The resonator frequency is synchronous to the operation of the  $\Delta\Sigma$  modulator to minimize interference with data transmission and support the high analog performance of the device.

The architecture of the DC/DC converter is optimized to drive the high-side circuitry of the AMC3330 and can source up to 1 mA of additional current ( $I_H$ ) for an optional auxiliary circuit such as an active filter, pre-amplifier, or comparator.

### 7.3.5 Diagnostic Output and Fail-Safe Behavior

The open-drain DIAG pin can be monitored to confirm the device is operational, and the output voltage is valid. During power-up, the DIAG pin is actively held low until the high-side supply is in regulation and the device operates properly. The DIAG pin is actively pulled low if:

- The low-side does not receive data from the high-side (for example, because of a loss of power on the high-side). The amplifier outputs are driven to negative full-scale.
- The high-side DC/DC output voltage (DCDC\_OUT) or the high-side LDO output voltage (HLDO\_OUT) drop below their respective undervoltage detection thresholds  $V_{DCDCUV}$  and  $V_{HLDOUV}$  as specified in the [Electrical Characteristics](#) table. In this case, the low-side may still receive data from the high-side but the data may not be valid. The amplifier outputs are driven to negative full-scale.

During normal operation, the DIAG pin is in a high-impedance state. Connect the DIAG pin to a pull-up supply through a resistor or leave open if not used.

## 7.4 Device Functional Modes

The AMC3330 is operational when the power supply VDD is applied, as specified in the [Recommended Operating Conditions](#) table.

## 8 Application and Implementation

### Note

Information in the following applications sections is not part of the TI component specification, and TI does not warrant its accuracy or completeness. TI's customers are responsible for determining suitability of components for their purposes. Customers should validate and test their design implementation to confirm system functionality.

### 8.1 Application Information

The low input bias current, AC and DC errors, and temperature drift make the AMC3330 a high-performance solution for applications where voltage measurement with high common-mode levels is required.

### 8.2 Typical Application

Isolated amplifiers are widely used for voltage measurements in high-voltage applications that must be isolated from a low-voltage domain. Typical applications are AC line voltage measurements at the input of a power factor correction (PFC) stage or the output of a solar inverter. Other applications are DC measurements at the output of a PFC stage or DC/DC converter, or phase voltage measurements in motor and servo drives. The AMC3330 integrates an isolated power supply for the high-voltage side and therefore is particularly easy to use in applications that do not have a high-side supply readily available or where a high-side supply is referenced to a different ground potential than the signal to be measured.

Figure 8-1 shows a simplified schematic of the AMC3330 in a solar inverter where the AC phase voltage on the grid-side must be measured. At that location in the system, there is no supply readily available for powering the isolated amplifier. The integrated isolated power supply, together with its bipolar input voltage range, makes the AMC3330 ideally suited for AC line-voltage sensing. In this example, phase current is sensed by the AMC3301 across a shunt resistor on the grid-side of an LCL filter where there is also no suitable supply available for powering the isolated amplifier. The integrated power supply of the AMC3301 eliminates that problem and enables current sensing at optimal locations for the system.

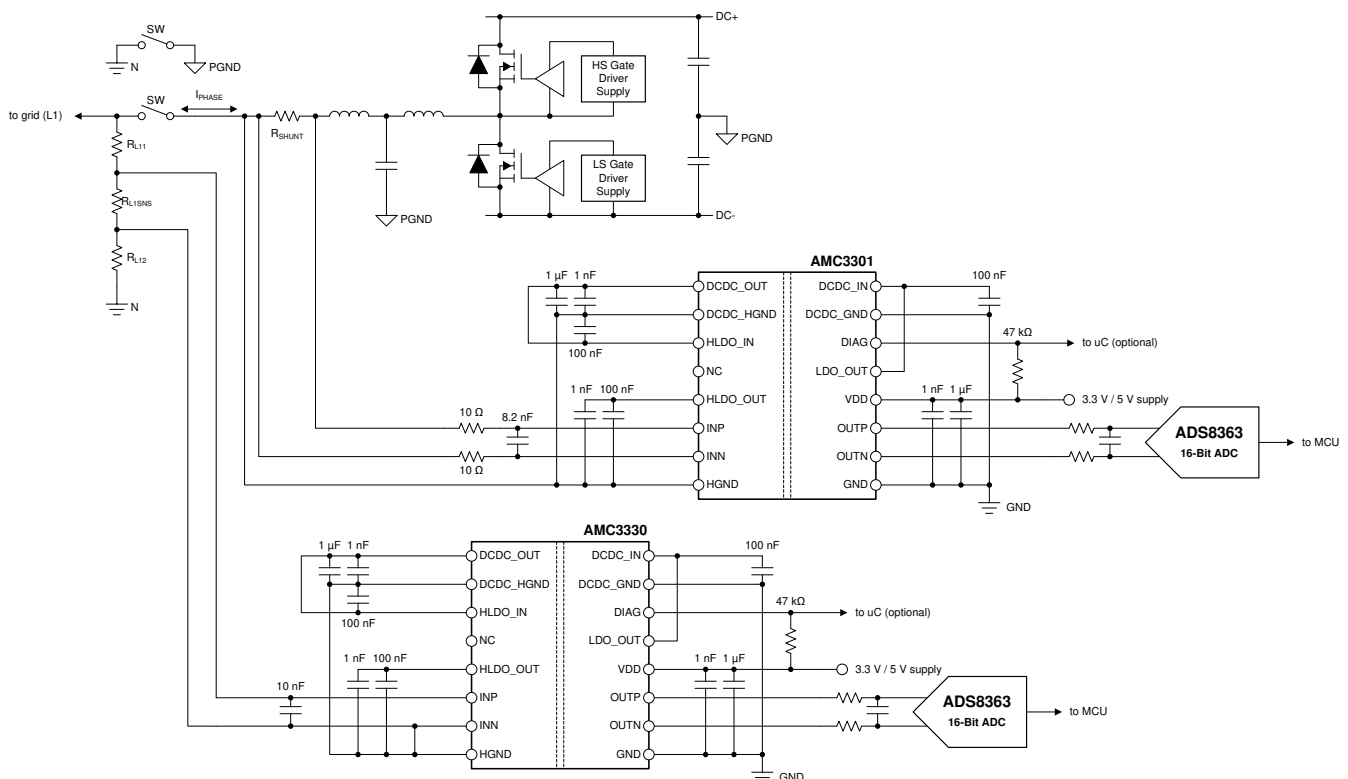

Figure 8-1. The AMC3330 in a Solar Inverter Application

## 8.2.1 Design Requirements

Table 8-1 lists the parameters for this typical application.

**Table 8-1. Design Requirements**

PARAMETER	VALUE
Low-side supply voltage	3.3 V or 5 V
Voltage drop across the sensing resistor for a linear response	1 V (maximum)
Current through the resistive divider, $I_{CROSS}$	100 $\mu$ A (maximum)

## 8.2.2 Detailed Design Procedure

Use Ohm's Law to calculate the minimum total resistance of the resistive divider to limit the cross current to the desired value ( $R_{TOTAL} = V_{LX} / I_{CROSS}$ ) and the required sense resistor value to be connected to the AMC3330 input:  $R_{SNS} = V_{FSR} / I_{CROSS}$ .

Consider the following two restrictions to choose the proper value of the sense resistor  $R_{SNS}$ :

- The voltage drop on  $R_{SNS}$  caused by the nominal voltage range of the system must not exceed the recommended input voltage range:  $V_{SNS} \leq V_{FSR}$
- The voltage drop on  $R_{SNS}$  caused by the maximum allowed system overvoltage must not exceed the input voltage that causes a clipping output:  $V_{SNS} \leq V_{Clipping}$

Table 8-2 lists examples of nominal E96-series (1% accuracy) resistor values for systems using 120-V and 230-V AC line voltages.

**Table 8-2. Resistor Value Examples**

PARAMETER	120-V <sub>RMS</sub> LINE VOLTAGE	120-V <sub>RMS</sub> LINE VOLTAGE	230-V <sub>RMS</sub> LINE VOLTAGE
Peak voltage	170 V	170 V	325 V
Resistive divider resistors $R_{L11}$ , $R_{L12}$	845 k $\Omega$	845 k $\Omega$	1.62 M $\Omega$
Sense resistor $R_{SNS}$	10 k $\Omega$	10 k $\Omega$	10 k $\Omega$
Current through resistive divider $I_{CROSS}$	100 $\mu$ A	100 $\mu$ A	100 $\mu$ A
Resulting voltage drop on sense resistor $V_{SNS}$	1.00 V	1.00 V	1.00 V

### 8.2.2.1 Input Filter Design

TI recommends placing an RC filter in front of the isolated amplifier to improve signal-to-noise performance of the signal path. Design the input filter such that:

- The cutoff frequency of the filter is at least one order of magnitude lower than the sampling frequency (20 MHz) of the internal  $\Delta\Sigma$  modulator
- The input bias current does not generate significant voltage drop across the DC impedance of the input filter
- The impedances measured from the analog inputs are equal

Most voltage sensing applications use high-impedance resistor dividers in front of the isolated amplifier to scale down the input voltage. In this case, a single capacitor shown in Figure 8-2 is sufficient to filter the input signal.

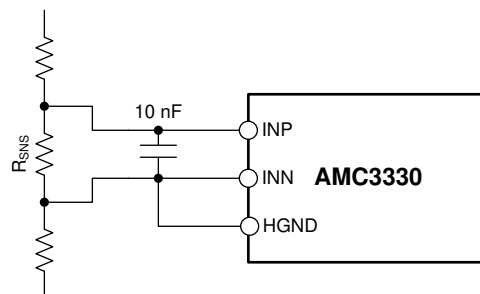

**Figure 8-2. Differential Input Filter**





## 9 Power Supply Recommendations

The AMC3330 is powered from the low-side power supply (VDD) with a nominal value of 3.3 V (or 5 V). TI recommends a low-ESR decoupling capacitor of 1 nF (C8 in Figure 9-1) placed as close as possible to the VDD pin, followed by a 1- $\mu$ F capacitor (C9) to filter this power-supply path.

The low-side of the DC/DC converter is decoupled with a low-ESR 100-nF capacitor (C4) positioned close to the device between the DCDC\_IN and DCDC\_GND pins. Use a 1- $\mu$ F capacitor (C2) to decouple the high-side in addition to a low-ESR, 1-nF capacitor (C3) placed as close as possible to the device and connected to the DCDC\_OUT and DCDC\_HGND pins.

For the high-side LDO, use low-ESR capacitors of 1-nF (C6), placed as close as possible to the AMC3330, followed by a 100-nF decoupling capacitor (C5).

The ground reference for the high-side (HGND) is derived from the terminal of the sense resistor which is connected to the negative input (INN) of the device. For best DC accuracy, use a separate trace to make this connection but shorting HGND to INN directly at the device input is also acceptable. The high-side DC/DC ground terminal(DCDC\_HGND) is shorted to HGND directly at the device pins.

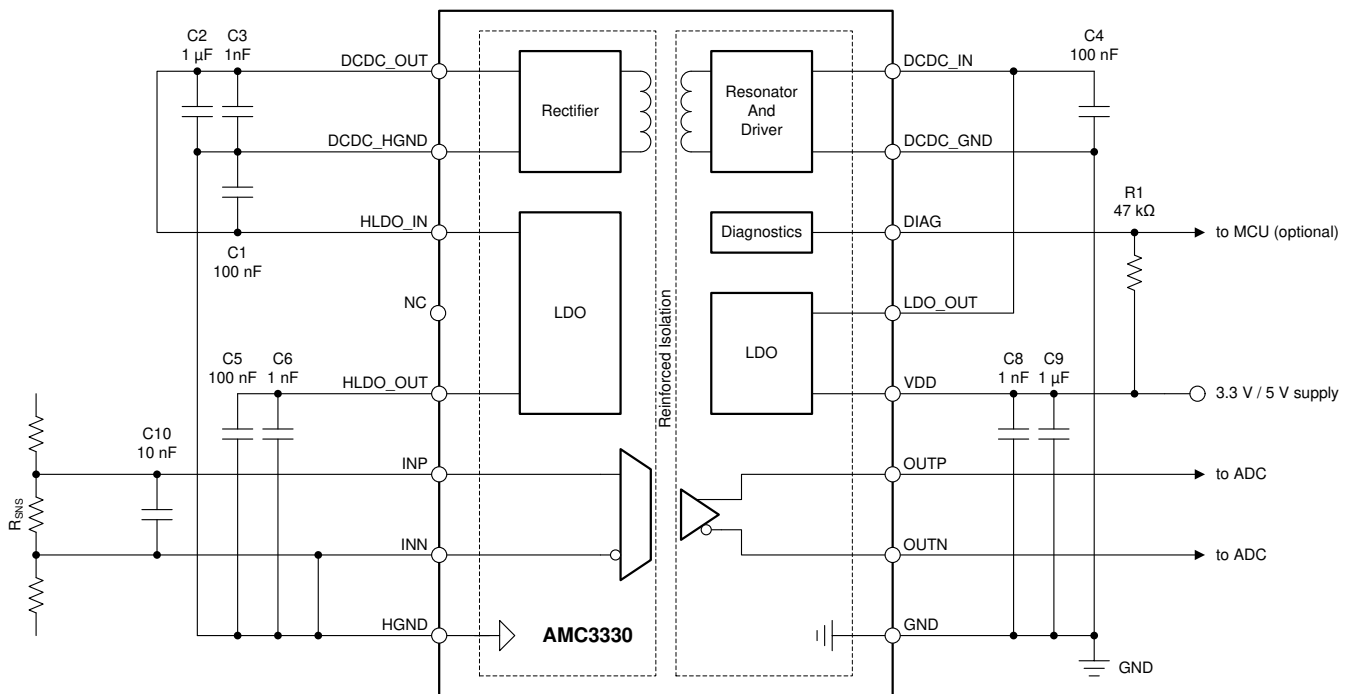

**Figure 9-1. Decoupling the AMC3330**

Capacitors must provide adequate *effective* capacitance under the applicable DC bias conditions they experience in the application. Multilayer ceramic capacitors (MLCC) capacitors typically exhibit only a fraction of their nominal capacitance under real-world conditions and this factor must be taken into consideration when selecting these capacitors. This problem is especially acute in low-profile capacitors, in which the dielectric field strength is higher than in taller components. Reputable capacitor manufacturers provide capacitance versus DC bias curves that greatly simplify component selection.

Table 9-1 lists components suitable for use with the AMC3330. This list is not exhaustive. Other components may exist that are equally suitable (or better), however these listed components have been validated during the development of the AMC3330.

**Table 9-1. Recommended External Components**

DESCRIPTION	PART NUMBER	MANUFACTURER	SIZE (EIA, L x W)	
<b>VDD</b>				
C8	1 nF ± 10%, X7R, 50 V	12065C102KAT2A	AVX	1206, 3.2 mm x 1.6 mm
C9	1 µF ± 10%, X7R, 25 V	12063C105KAT2A	AVX	1206, 3.2 mm x 1.6 mm
<b>DC/DC CONVERTER</b>				
C4	100 nF ± 10%, X7R, 50 V	C0603C104K5RACAUTO	Kemet	0603, 1.6 mm x 0.8 mm
C3	1 nF ± 10%, X7R, 50 V	C0603C102K5RACTU	Kemet	0603, 1.6 mm x 0.8 mm
C2	1 µF ± 10%, X7R, 25 V	CGA3E1X7R1E105K080AC	TDK	0603, 1.6 mm x 0.8 mm
<b>HLDO</b>				
C1	100 nF ± 10%, X7R, 50 V	C0603C104K5RACAUTO	Kemet	0603, 1.6 mm x 0.8 mm
C5	100 nF ± 5%, NP0, 50 V	C3216NP01H104J160AA	TDK	1206, 3.2 mm x 1.6 mm
C6	1 nF ± 10%, X7R, 50 V	12065C102KAT2A	AVX	1206, 3.2 mm x 1.6 mm

## 10 Layout

### 10.1 Layout Guidelines

Figure 10-1 shows a layout recommendation with the critical placement of the decoupling capacitors. The same component reference designators are used as in the *Power Supply Recommendations* section. Decoupling capacitors are placed as close as possible to the AMC3330 supply pins. For best performance, place the sense resistor close to the INP and INN inputs of the AMC3330 and keep the layout of both connections symmetrical.

This layout is used on the AMC3330 EVM and supports CISPR-11 compliant electromagnetic radiation levels.

### 10.2 Layout Example

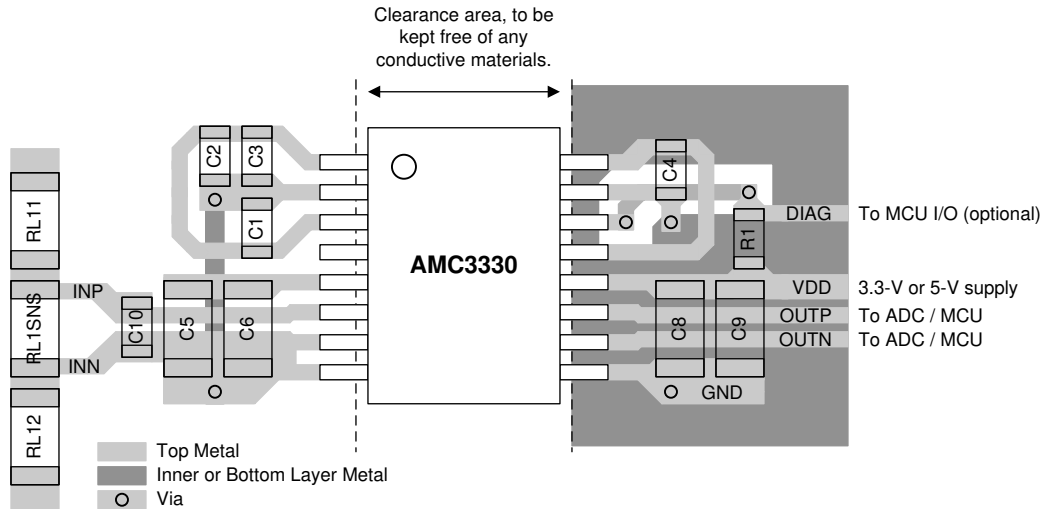

**Figure 10-1. Recommended Layout of the AMC3330**

## 11 Device and Documentation Support

### 11.1 Device Support

#### 11.1.1 Device Nomenclature

Texas Instruments, [Isolation Glossary](#)

### 11.2 Documentation Support

#### 11.2.1 Related Documentation

For related documentation see the following:

- Texas Instruments, [ISO72x Digital Isolator Magnetic-Field Immunity application report](#)
- Texas Instruments, [AMC3301 Precision, ±250-mV Input, Reinforced Isolated Amplifier With Integrated DC/DC Converter data sheet](#)
- Texas Instruments, [TLV600x Low-Power, Rail-to-Rail In/Out, 1-MHz Operational Amplifier for Cost-Sensitive Systems data sheet](#)
- Texas Instruments, [18-Bit, 1MSPS Data Acquisition Block \(DAQ\) Optimized for Lowest Distortion and Noise reference guide](#)
- Texas Instruments, [18-Bit Data Acquisition Block \(DAQ\) Optimized for Lowest Power reference guide](#)

### 11.3 Receiving Notification of Documentation Updates

To receive notification of documentation updates, navigate to the device product folder on [ti.com](#). Click on [Subscribe to updates](#) to register and receive a weekly digest of any product information that has changed. For change details, review the revision history included in any revised document.

### 11.4 Support Resources

[TI E2E™ support forums](#) are an engineer's go-to source for fast, verified answers and design help — straight from the experts. Search existing answers or ask your own question to get the quick design help you need.

Linked content is provided "AS IS" by the respective contributors. They do not constitute TI specifications and do not necessarily reflect TI's views; see TI's [Terms of Use](#).

### 11.5 Trademarks

TI E2E™ is a trademark of Texas Instruments.

All other trademarks are the property of their respective owners.

### 11.6 Electrostatic Discharge Caution



This integrated circuit can be damaged by ESD. Texas Instruments recommends that all integrated circuits be handled with appropriate precautions. Failure to observe proper handling and installation procedures can cause damage.

ESD damage can range from subtle performance degradation to complete device failure. Precision integrated circuits may be more susceptible to damage because very small parametric changes could cause the device not to meet its published specifications.

### 11.7 Glossary

[TI Glossary](#) This glossary lists and explains terms, acronyms, and definitions.

## 12 Mechanical, Packaging, and Orderable Information

The following pages include mechanical, packaging, and orderable information. This information is the most current data available for the designated devices. This data is subject to change without notice and revision of this document. For browser-based versions of this data sheet, refer to the left-hand navigation.

**PACKAGING INFORMATION**

Orderable Device	Status (1)	Package Type	Package Drawing	Pins	Package Qty	Eco Plan (2)	Lead finish/ Ball material (6)	MSL Peak Temp (3)	Op Temp (°C)	Device Marking (4/5)	Samples
AMC3330DWE	ACTIVE	SOIC	DWE	16	40	RoHS & Green	NIPDAU	Level-3-260C-168 HR	-40 to 125	AMC3330	<a href="#">Samples</a>
AMC3330DWER	ACTIVE	SOIC	DWE	16	2000	RoHS & Green	NIPDAU	Level-3-260C-168 HR	-40 to 125	AMC3330	<a href="#">Samples</a>

(1) The marketing status values are defined as follows:

**ACTIVE:** Product device recommended for new designs.

**LIFEBUY:** TI has announced that the device will be discontinued, and a lifetime-buy period is in effect.

**NRND:** Not recommended for new designs. Device is in production to support existing customers, but TI does not recommend using this part in a new design.

**PREVIEW:** Device has been announced but is not in production. Samples may or may not be available.

**OBSOLETE:** TI has discontinued the production of the device.

(2) **RoHS:** TI defines "RoHS" to mean semiconductor products that are compliant with the current EU RoHS requirements for all 10 RoHS substances, including the requirement that RoHS substance do not exceed 0.1% by weight in homogeneous materials. Where designed to be soldered at high temperatures, "RoHS" products are suitable for use in specified lead-free processes. TI may reference these types of products as "Pb-Free".

**RoHS Exempt:** TI defines "RoHS Exempt" to mean products that contain lead but are compliant with EU RoHS pursuant to a specific EU RoHS exemption.

**Green:** TI defines "Green" to mean the content of Chlorine (Cl) and Bromine (Br) based flame retardants meet JS709B low halogen requirements of <=1000ppm threshold. Antimony trioxide based flame retardants must also meet the <=1000ppm threshold requirement.

(3) MSL, Peak Temp. - The Moisture Sensitivity Level rating according to the JEDEC industry standard classifications, and peak solder temperature.

(4) There may be additional marking, which relates to the logo, the lot trace code information, or the environmental category on the device.

(5) Multiple Device Markings will be inside parentheses. Only one Device Marking contained in parentheses and separated by a "~" will appear on a device. If a line is indented then it is a continuation of the previous line and the two combined represent the entire Device Marking for that device.

(6) Lead finish/Ball material - Orderable Devices may have multiple material finish options. Finish options are separated by a vertical ruled line. Lead finish/Ball material values may wrap to two lines if the finish value exceeds the maximum column width.

**Important Information and Disclaimer:**The information provided on this page represents TI's knowledge and belief as of the date that it is provided. TI bases its knowledge and belief on information provided by third parties, and makes no representation or warranty as to the accuracy of such information. Efforts are underway to better integrate information from third parties. TI has taken and continues to take reasonable steps to provide representative and accurate information but may not have conducted destructive testing or chemical analysis on incoming materials and chemicals. TI and TI suppliers consider certain information to be proprietary, and thus CAS numbers and other limited information may not be available for release.

In no event shall TI's liability arising out of such information exceed the total purchase price of the TI part(s) at issue in this document sold by TI to Customer on an annual basis.

**OTHER QUALIFIED VERSIONS OF AMC3330 :**

- Automotive : [AMC3330-Q1](#)

## NOTE: Qualified Version Definitions:

- Automotive - Q100 devices qualified for high-reliability automotive applications targeting zero defects

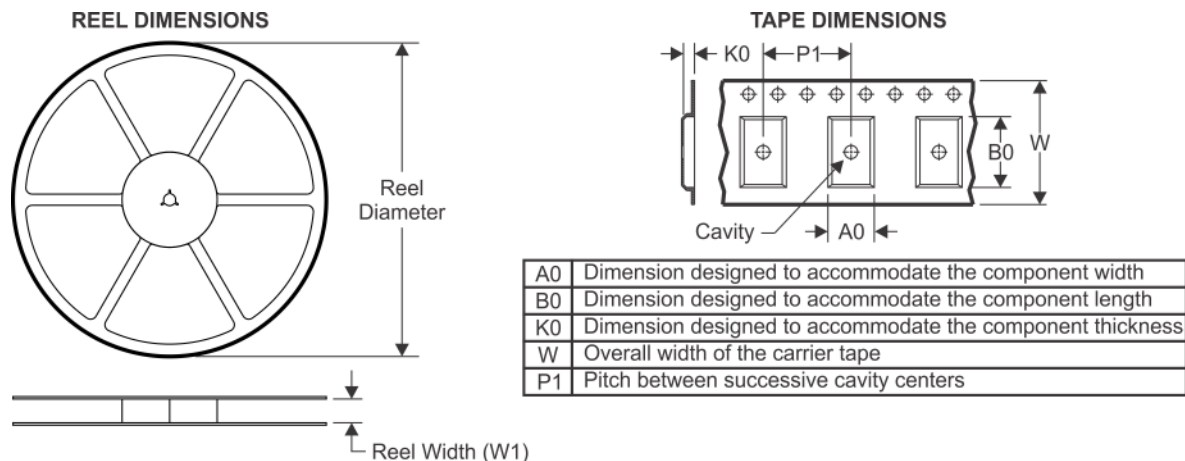
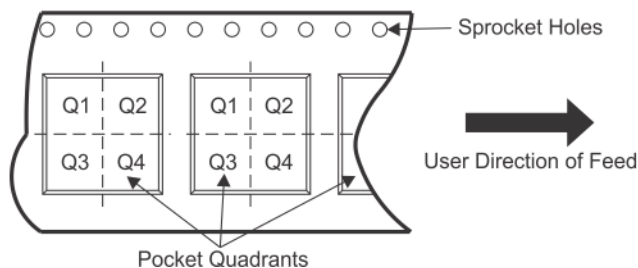
**TAPE AND REEL INFORMATION**

**QUADRANT ASSIGNMENTS FOR PIN 1 ORIENTATION IN TAPE**

\*All dimensions are nominal

Device	Package Type	Package Drawing	Pins	SPQ	Reel Diameter (mm)	Reel Width W1 (mm)	A0 (mm)	B0 (mm)	K0 (mm)	P1 (mm)	W (mm)	Pin1 Quadrant
AMC3330DWER	SOIC	DWE	16	2000	330.0	16.4	10.75	10.7	2.7	12.0	16.0	Q1

**TAPE AND REEL BOX DIMENSIONS**

\*All dimensions are nominal

Device	Package Type	Package Drawing	Pins	SPQ	Length (mm)	Width (mm)	Height (mm)
AMC3330DWER	SOIC	DWE	16	2000	350.0	350.0	43.0

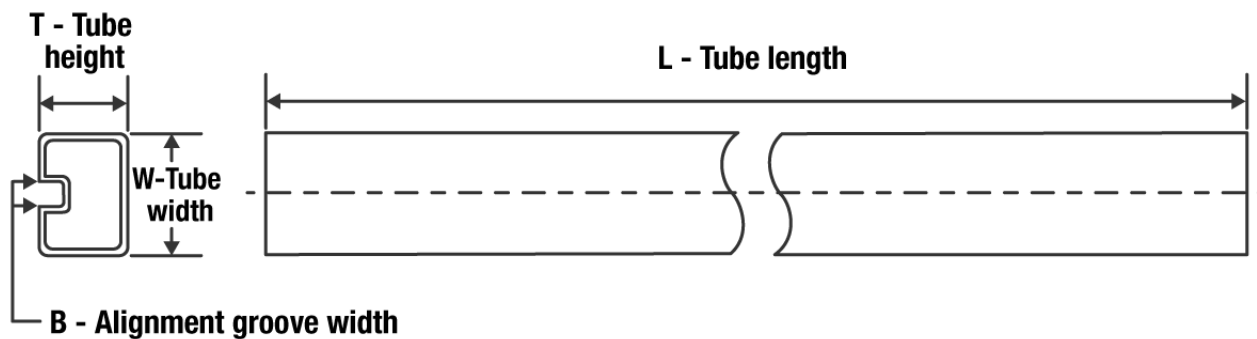

**TUBE**

\*All dimensions are nominal

Device	Package Name	Package Type	Pins	SPQ	L (mm)	W (mm)	T (μm)	B (mm)
AMC3330DWE	DWE	SO-MOD	16	40	506.98	12.7	4826	6.6



# DWE0016A

# PACKAGE OUTLINE

## SOIC - 2.65 mm max height

SOIC

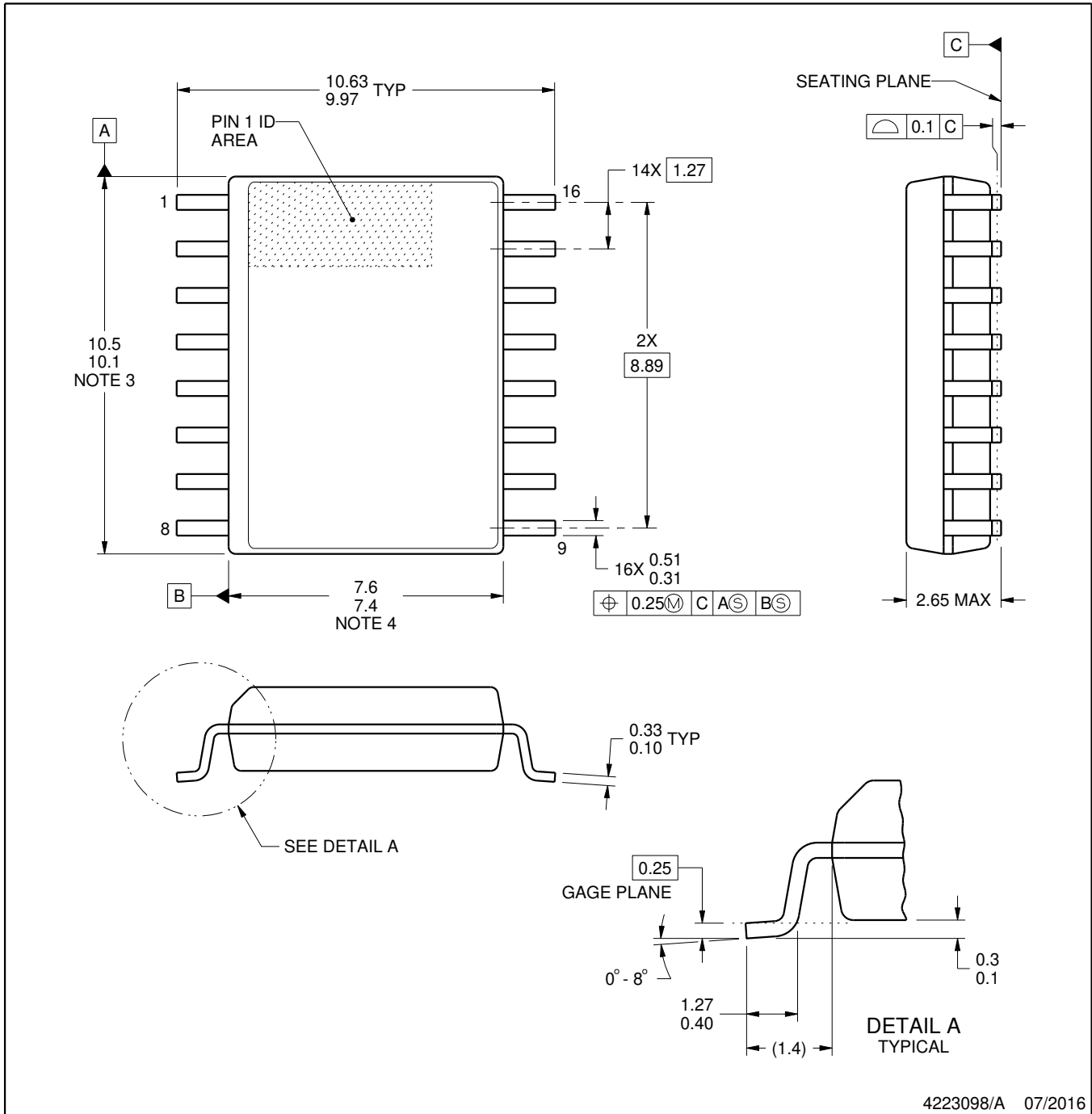

4223098/A 07/2016

### NOTES:

1. All linear dimensions are in millimeters. Any dimensions in parenthesis are for reference only. Dimensioning and tolerancing per ASME Y14.5M.
2. This drawing is subject to change without notice.
3. This dimension does not include mold flash, protrusions, or gate burrs. Mold flash, protrusions, or gate burrs shall not exceed 0.15 mm, per side.
4. This dimension does not include interlead flash. Interlead flash shall not exceed 0.25 mm, per side.
5. Reference JEDEC registration MS-013.

# EXAMPLE BOARD LAYOUT

DWE0016A

SOIC - 2.65 mm max height

SOIC

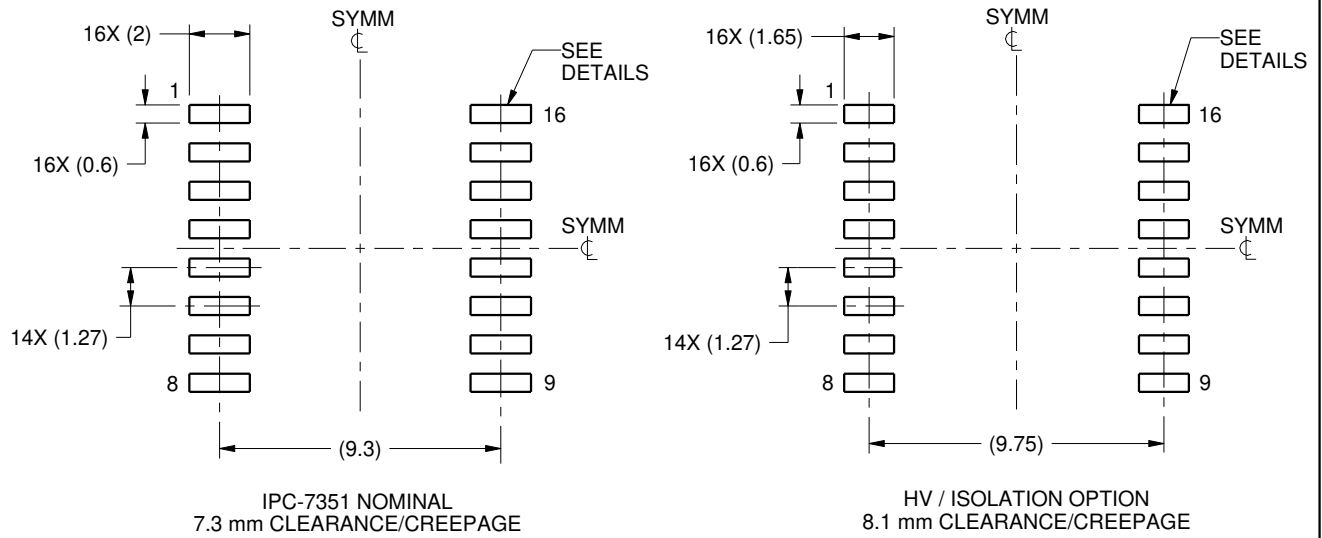

LAND PATTERN EXAMPLE  
SCALE:4X

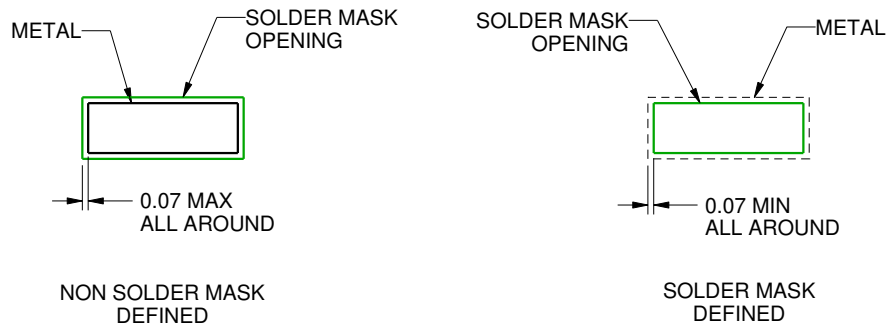

SOLDER MASK DETAILS

4223098/A 07/2016

NOTES: (continued)

- 6. Publication IPC-7351 may have alternate designs.
- 7. Solder mask tolerances between and around signal pads can vary based on board fabrication site.

# EXAMPLE STENCIL DESIGN

DWE0016A

SOIC - 2.65 mm max height

SOIC

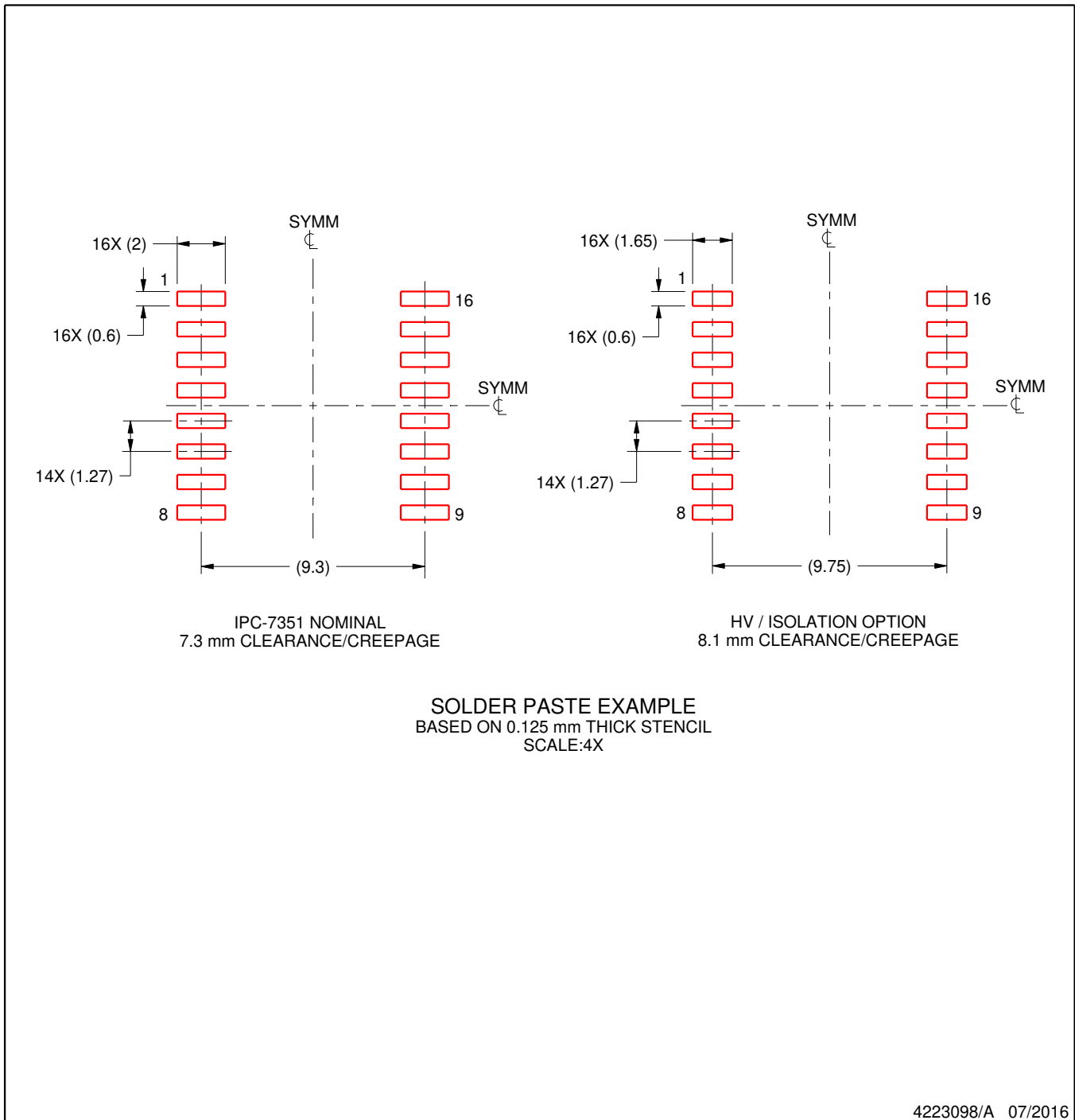

NOTES: (continued)

8. Laser cutting apertures with trapezoidal walls and rounded corners may offer better paste release. IPC-7525 may have alternate design recommendations.
9. Board assembly site may have different recommendations for stencil design.

## IMPORTANT NOTICE AND DISCLAIMER

TI PROVIDES TECHNICAL AND RELIABILITY DATA (INCLUDING DATA SHEETS), DESIGN RESOURCES (INCLUDING REFERENCE DESIGNS), APPLICATION OR OTHER DESIGN ADVICE, WEB TOOLS, SAFETY INFORMATION, AND OTHER RESOURCES "AS IS" AND WITH ALL FAULTS, AND DISCLAIMS ALL WARRANTIES, EXPRESS AND IMPLIED, INCLUDING WITHOUT LIMITATION ANY IMPLIED WARRANTIES OF MERCHANTABILITY, FITNESS FOR A PARTICULAR PURPOSE OR NON-INFRINGEMENT OF THIRD PARTY INTELLECTUAL PROPERTY RIGHTS.

These resources are intended for skilled developers designing with TI products. You are solely responsible for (1) selecting the appropriate TI products for your application, (2) designing, validating and testing your application, and (3) ensuring your application meets applicable standards, and any other safety, security, regulatory or other requirements.

These resources are subject to change without notice. TI grants you permission to use these resources only for development of an application that uses the TI products described in the resource. Other reproduction and display of these resources is prohibited. No license is granted to any other TI intellectual property right or to any third party intellectual property right. TI disclaims responsibility for, and you will fully indemnify TI and its representatives against, any claims, damages, costs, losses, and liabilities arising out of your use of these resources.

TI's products are provided subject to [TI's Terms of Sale](#) or other applicable terms available either on [ti.com](http://ti.com) or provided in conjunction with such TI products. TI's provision of these resources does not expand or otherwise alter TI's applicable warranties or warranty disclaimers for TI products.

TI objects to and rejects any additional or different terms you may have proposed.

Mailing Address: Texas Instruments, Post Office Box 655303, Dallas, Texas 75265  
Copyright © 2022, Texas Instruments Incorporated