



TAOGLAS®



Datasheet

Part No:
FXUB71.A.07.C.001

Description:

5G/4G 2*MIMO Wideband 600-6000MHz Flex Circuit PCB
with 150mm of 1.37 and I-PEX MHF I

Features:

Flexible PCB Antenna for ease of installation
Worldwide 5G functionality with 4G and 3G/2G
Wideband 600-6000MHz Operational
Dimensions: 240mm*21mm*0.15mm
Cable: 150mm 1.37
Connector: I-PEX MHF I (U.FL compatible)
3M adhesive tape for "Peel and Stick" Mounting
RoHS & Reach Compliant

1. Introduction	3
2. Specifications	4
3. Antenna Characteristics	6
4. Radiation Patterns	9
5. Mechanical Drawing	30
6. Packaging	31
<hr/>	
Changelog	32

Taoglas makes no warranties based on the accuracy or completeness of the contents of this document and reserves the right to make changes to specifications and product descriptions at any time without notice. Taoglas reserves all rights to this document and the information contained herein. Reproduction, use or disclosure to third parties without express permission is strictly prohibited.



1. Introduction



The patent pending FXUB71 antenna is an industry leading embedded 5G/4G 2*2 MIMO flexible polymer monopole type antenna for worldwide 5G/4G applications, which operates across the full 600-6000MHz spectrum. The antenna comes with a micro coax cable and connector, and has good efficiency and isolation between ports, critical for optimal 5G/4G wireless performance.

Typical applications

- Gateways and Routers
- High speed HD streaming
- Wireless Access Points
- Handheld Devices
- High capacity MIMO networks for Public Transportation

With over 30% efficiency on all bands, isolation performance between the two ports is under -10dB in all bands. The antenna has been designed in a slim rectangular form-factor, with its own automotive quality 3M 467 adhesive backing tape, to ensure good isolation and convenient installation into typical M2M/IOT devices. Simply peel and stick onto your plastic housing.

The antenna is tuned to work on a reference ABS plastic of 2mm of thickness which is a common standard for most device plastics. Cable routing has been carefully planned to ensure no cross-over of cable, and a logical and hassle free installation. Like all such antennas, care should be taken to mount the antenna at least 10mm from metal components or surfaces, and ideally 20mm for best radiation efficiency.

Before integration of the antenna in your device, especially if you require PTCRB or US network approvals, please contact your regional Taoglas customer support team. Cable length and connector type are fully customizable, for further information please contact your regional Taoglas customer support team.

2. Specifications

Electrical

Band	Frequency (MHz)		Efficiency (%)	Average Gain (dB)	Peak Gain (dBi)	Impedance	Max Input Power	Polarization	Radiation Pattern
5G NR/4G Band 71	617~698	MIMO 1	33.7	-4.73	1.08	50 Ω	2W	Linear	Omni-Directional
		MIMO 2	32.7	-4.85	1.18				
4G/3G Band 12,13,14,17,28,29	698~806	MIMO 1	34.5	-4.62	1.48				
		MIMO 2	34.3	-4.65	1.68				
4G/3G/NB-IoT/Cat M Band 5,8,18,19,20,26,27	824~960	MIMO 1	37.2	-4.29	1.46				
		MIMO 2	38.9	-4.10	1.71				
5G NR/4G Band 21,32,74,75,76	1427~1518	MIMO 1	75.7	-1.21	3.56				
		MIMO 2	74.1	-1.30	3.79				
4G/3G Band 1,2,3,4,9,23,25,35,39,66	1710~2200	MIMO 1	72.5	-1.39	4.83				
		MIMO 2	70.8	-1.50	4.51				
4G/3G Band 7,30,38,40,41	2300~2690	MIMO 1	63.0	-2.01	4.01				
		MIMO 2	64.5	-1.91	3.78				
5G NR/4G Band 22,42,48,77,78	3300~4200	MIMO 1	46.9	-3.29	3.85				
		MIMO 2	53.8	-2.69	3.66				
LTE5200/ Wi-Fi 5800	5150~5925	MIMO 1	35.4	-4.51	3.76				
		MIMO 2	36.4	-4.39	5.26				

*Tested on 2mm ABS

Mechanical

Dimensions	240mm X 21mm X 0.15mm
Weight	4.2g
Material	Flexible Polymer
Connector	I-PEX MHF I (U.FL Compatible)
Cable	Ø1.37 Coaxial cable 150mm
Adhesive	3M 467

Environmental

Temperature Range	-40°C to 85°C
-------------------	---------------

5G/4G Bands			
Band Number	5G NR / FR1 / LTE / LTE-Advanced / WCDMA / HSPA / HSPA+ / TD-SCDMA		
	Uplink	Downlink	Covered
1	UL: 1920 to 1980	DL: 2110 to 2170	✓
2	UL: 1850 to 1910	DL: 1930 to 1990	✓
3	UL: 1710 to 1785	DL: 1805 to 1880	✓
4	UL: 1710 to 1755	DL: 2110 to 2155	✓
5	UL: 824 to 849	DL: 869 to 894	✓
7	UL: 2500 to 2570	DL: 2620 to 2690	✓
8	UL: 880 to 915	DL: 925 to 960	✓
9	UL: 1749.9 to 1784.9	DL: 1844.9 to 1879.9	✓
11	UL: 1427.9 to 1447.9	DL: 1475.9 to 1495.9	✓
12	UL: 699 to 716	DL: 729 to 746	✓
13	UL: 777 to 787	DL: 746 to 756	✓
14	UL: 788 to 798	DL: 758 to 768	✓
17	UL: 704 to 716	DL: 734 to 746	✓
18	UL: 815 to 830	DL: 860 to 875	✓
19	UL: 830 to 845	DL: 875 to 890	✓
20	UL: 832 to 862	DL: 791 to 821	✓
21	UL: 1447.9 to 1462.9	DL: 1495.9 to 1510.9	✓
22	UL: 3410 to 3490	DL: 3510 to 3590	✓
23	UL: 2000 to 2020	DL: 2180 to 2200	✓
24	UL: 1625.5 to 1660.5	DL: 1525 to 1559	✓
25	UL: 1850 to 1915	DL: 1930 to 1995	✓
26	UL: 814 to 849	DL: 859 to 894	✓
27	UL: 807 to 824	DL: 852 to 869	✓
28	UL: 703 to 748	DL: 758 to 803	✓
29	UL: -	DL: 717 to 728	✓
30	UL: 2305 to 2315	DL: 2350 to 2360	✓
31	UL: 452.5 to 457.5	DL: 462.5 to 467.5	✗
32	UL: -	DL: 1452 - 1496	✓
35		1850 to 1910	✓
38		2570 to 2620	✓
39		1880 to 1920	✓
40		2300 to 2400	✓
41		2496 to 2690	✓
42		3400 to 3600	✓
43		3600 to 3800	✓
48		3550 to 3700	✓
66	UL: 1710-1780	DL: 2110-2200	✓
71		617 to 698	✓
74/75/76		1427 to 1518	✓
77		3300 to 4200	✓
78		3300 to 3800	✓
79		4400 to 5000	✓

3. Antenna Characteristics

3.1 Return Loss

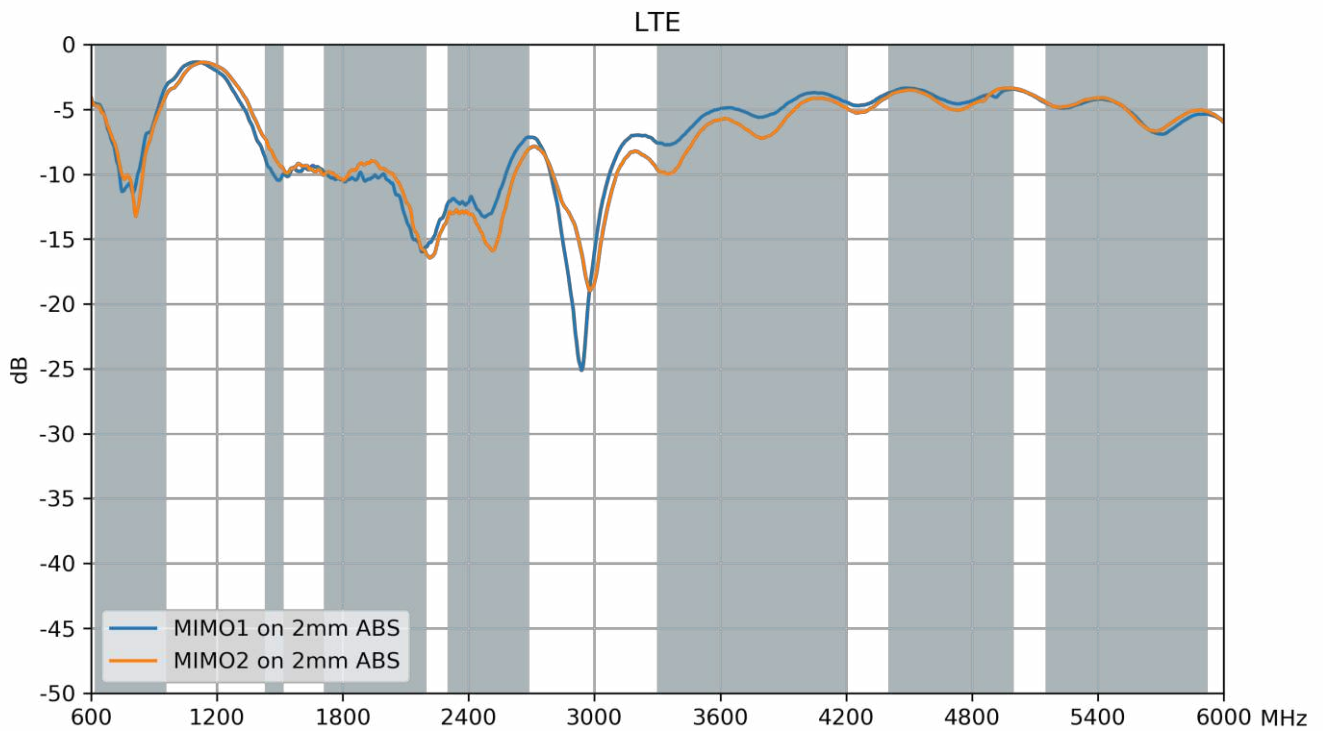

3.2 Isolation

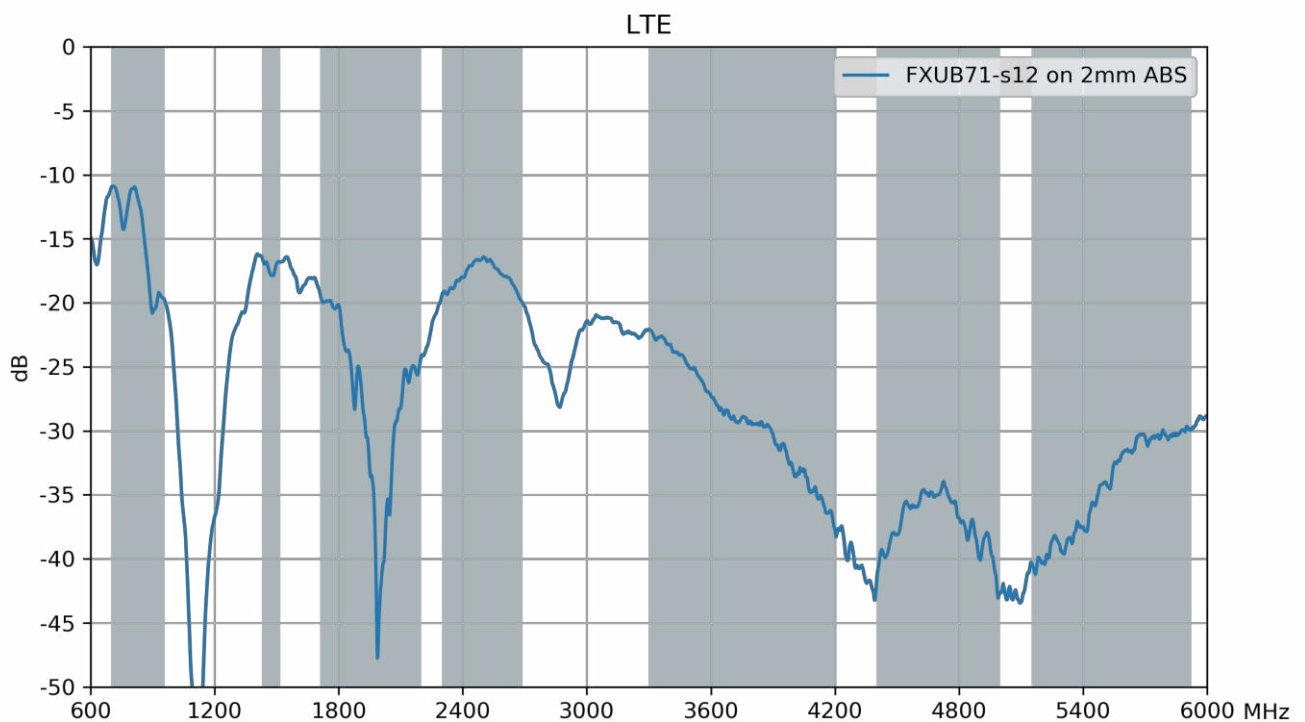

3.3 Efficiency

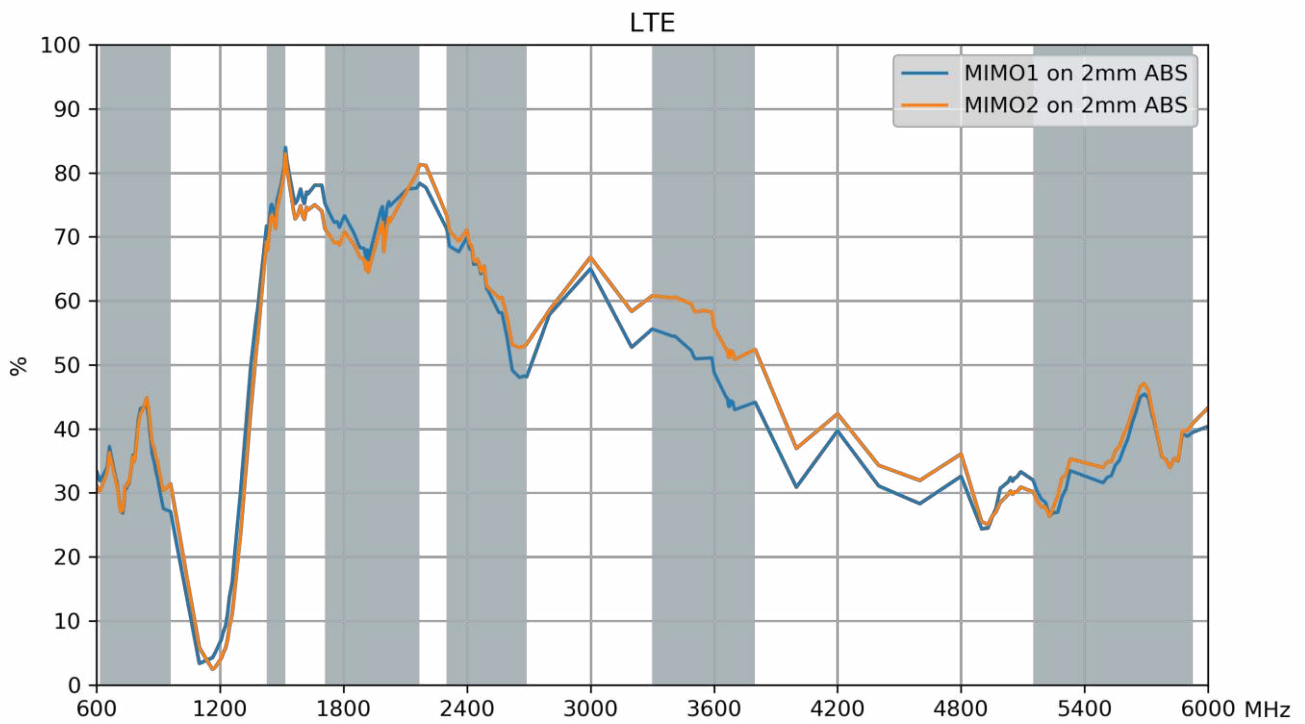

3.4 Average Gain

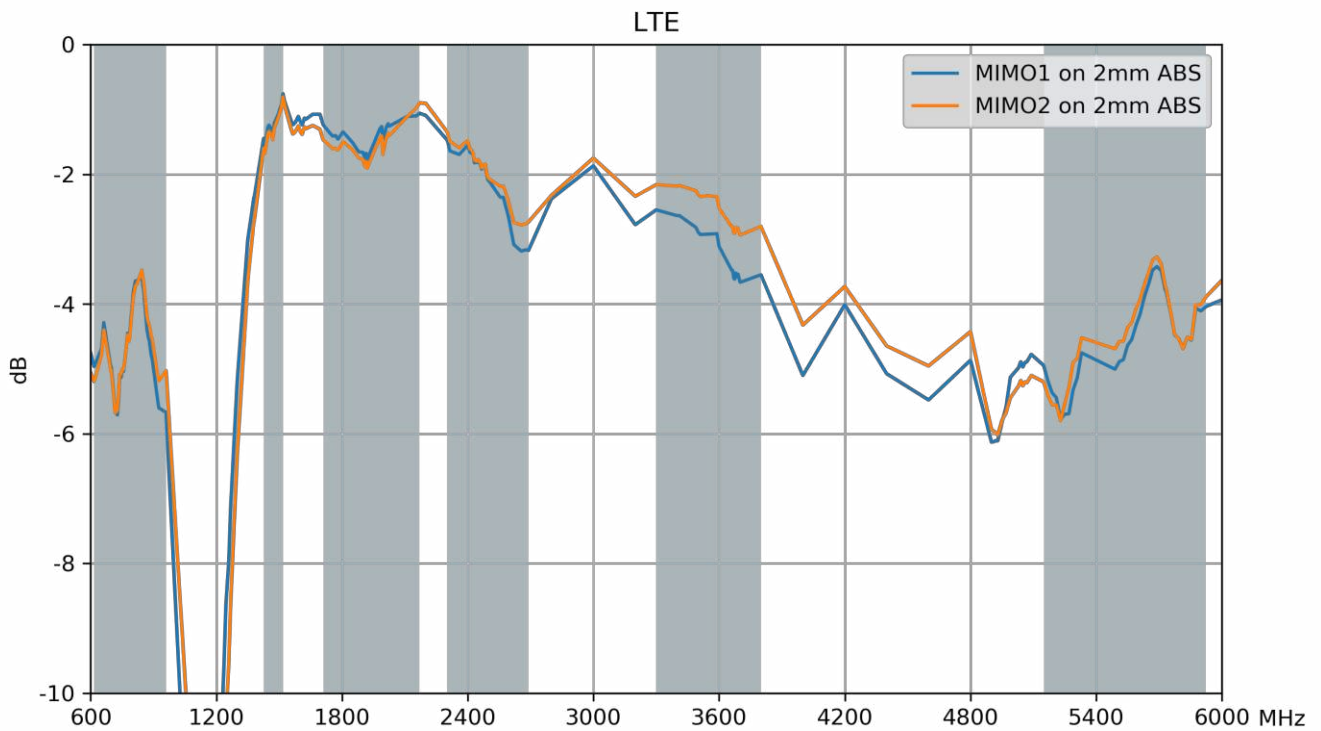

3.5 Peak Gain

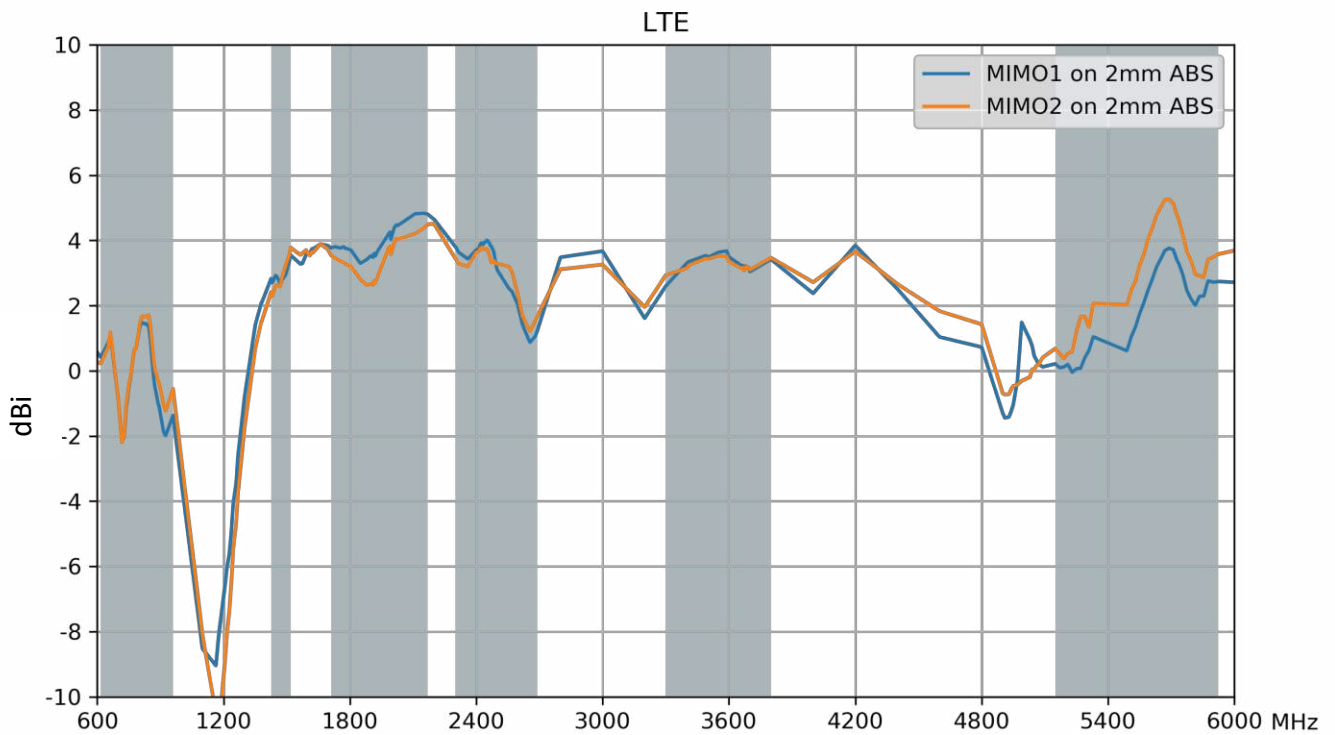

4. Radiation Patterns

4.1 Test Setup – 2mm ABS

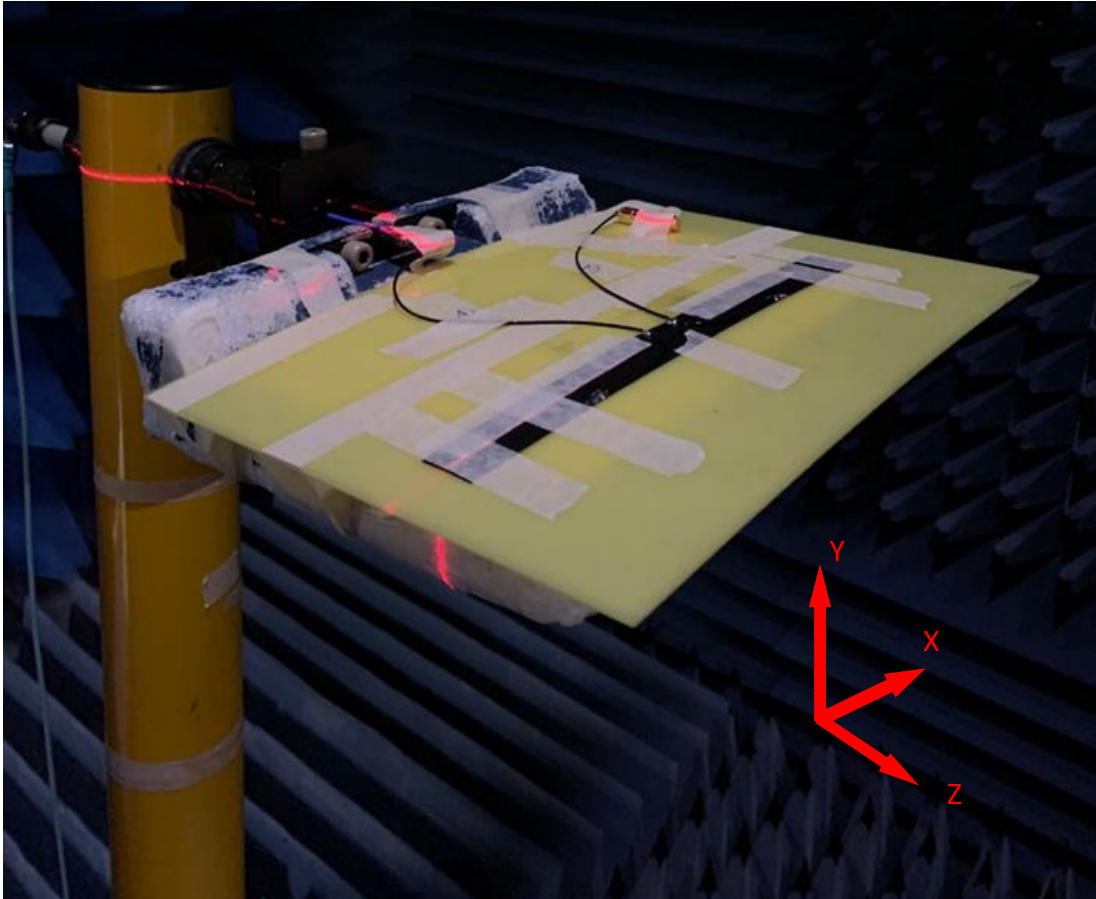

4.2 MIMO 1, 3D and 2D Radiation Patterns

652MHz

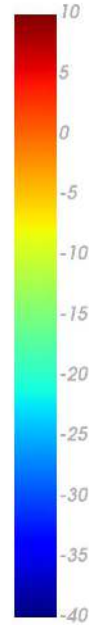
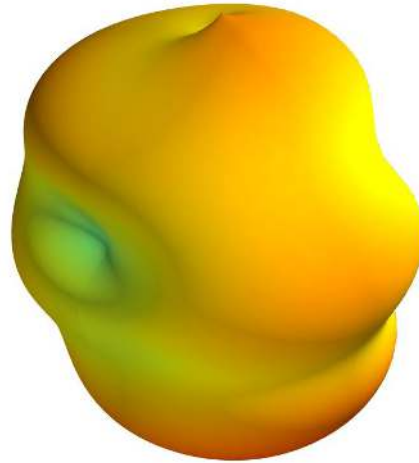

XY Plane

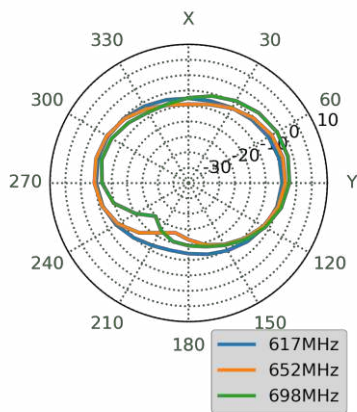

XZ Plane

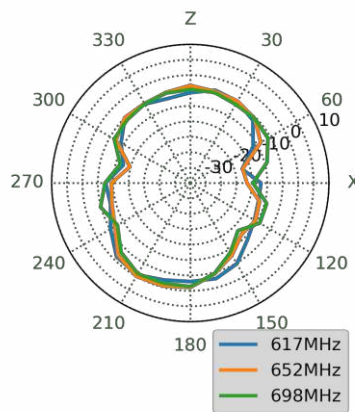

YZ Plane

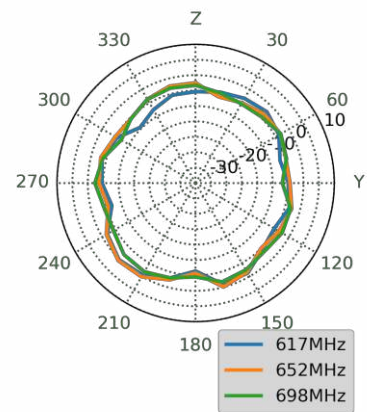

751MHz

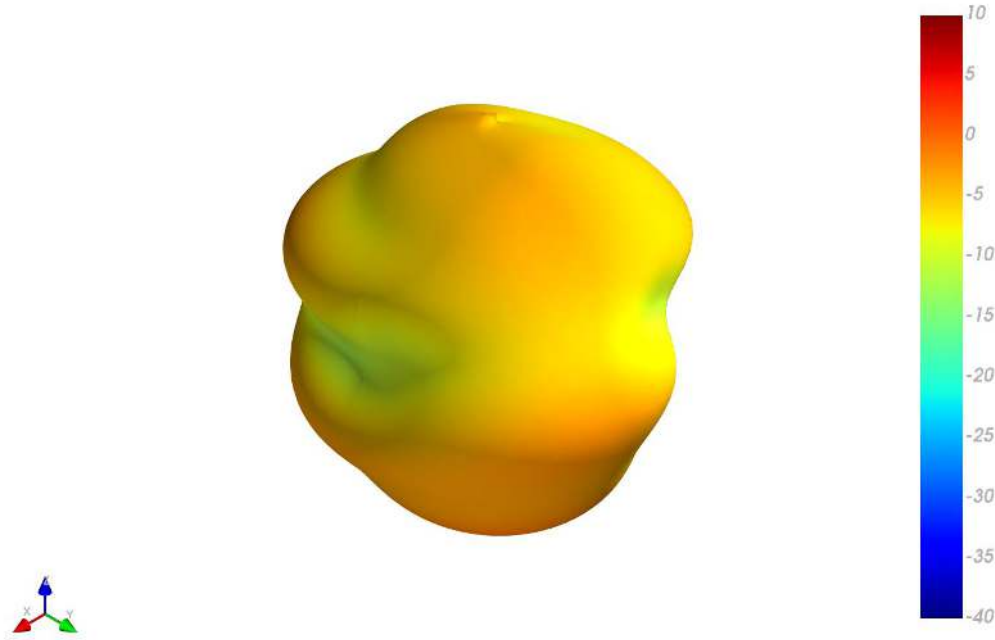

XY Plane

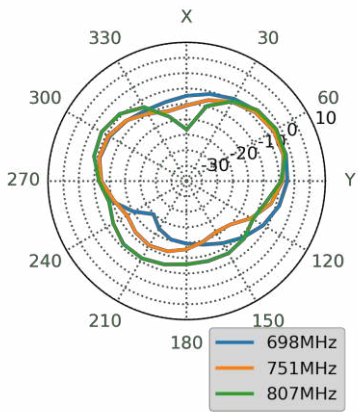

XZ Plane

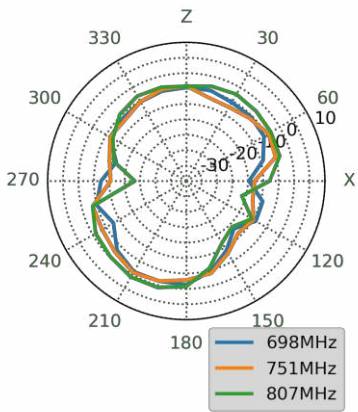

YZ Plane

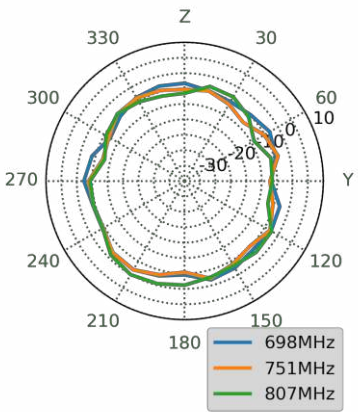

890MHz

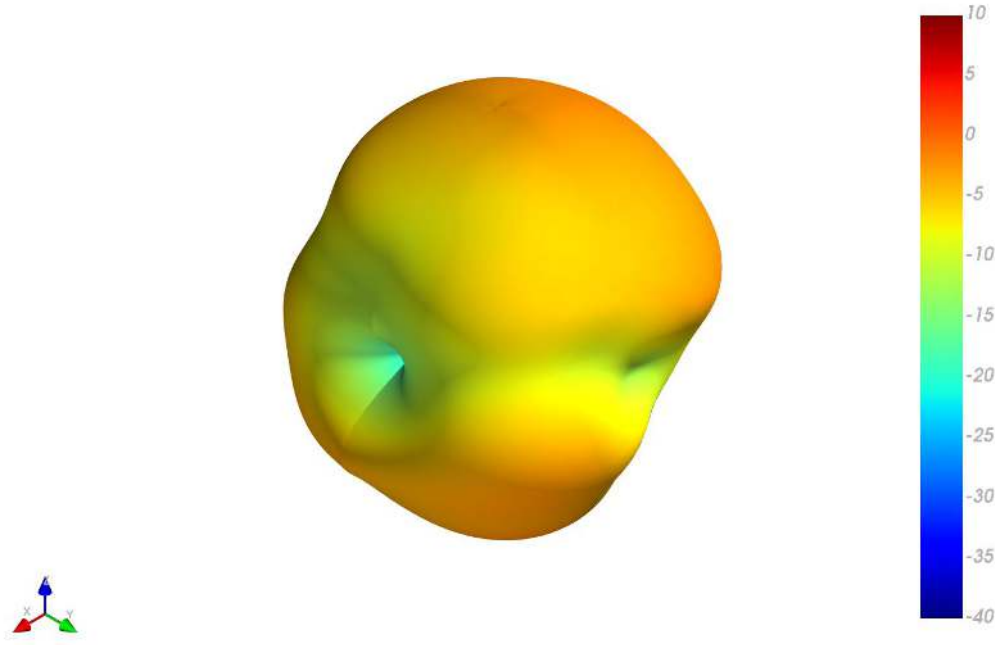

XY Plane

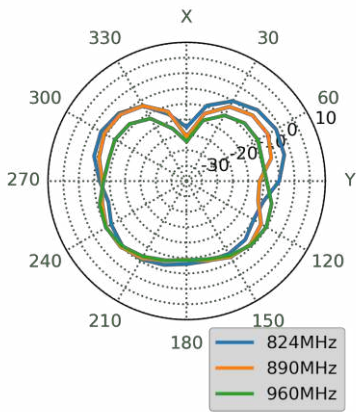

XZ Plane

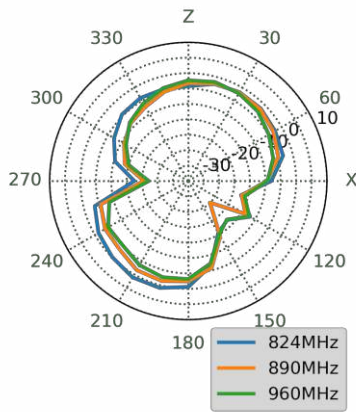

YZ Plane

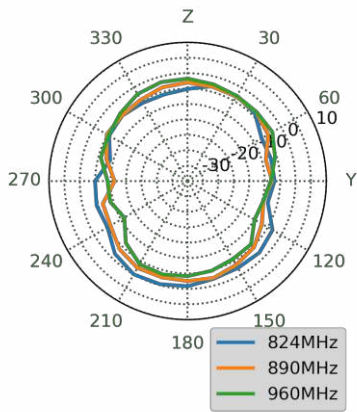

1470MHz

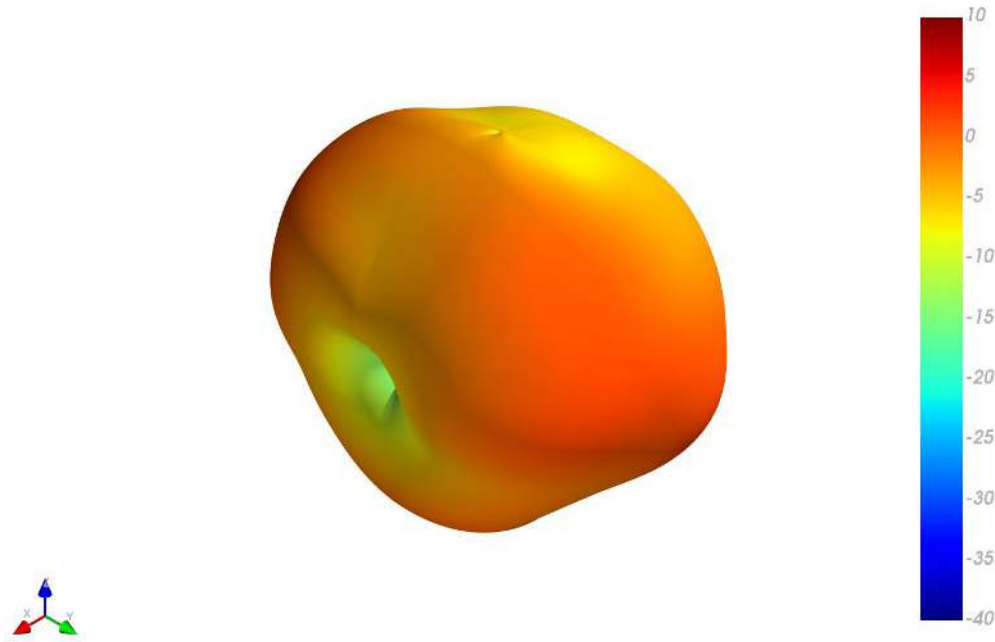

XY Plane

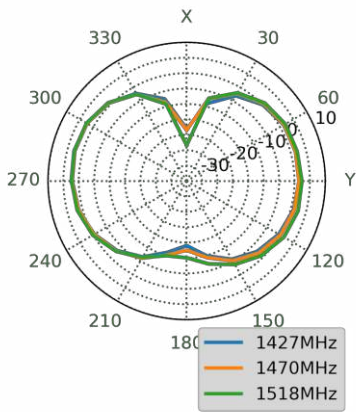

XZ Plane

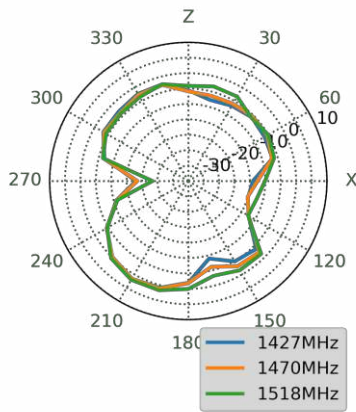

YZ Plane

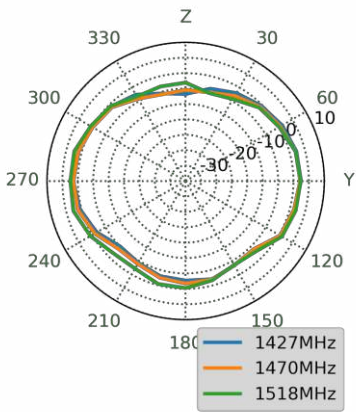

1805MHz

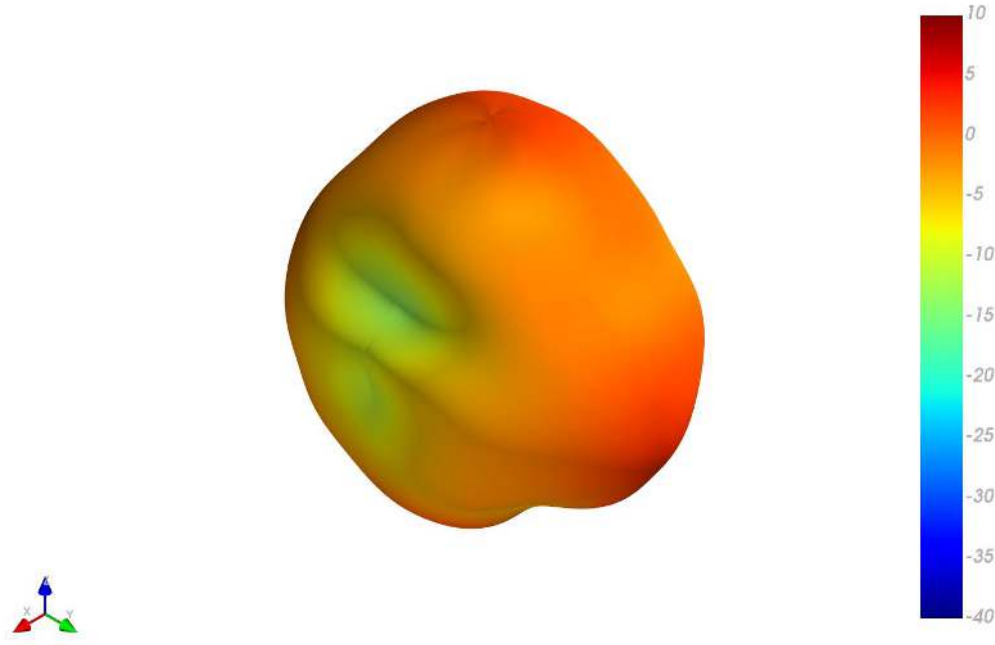

XY Plane

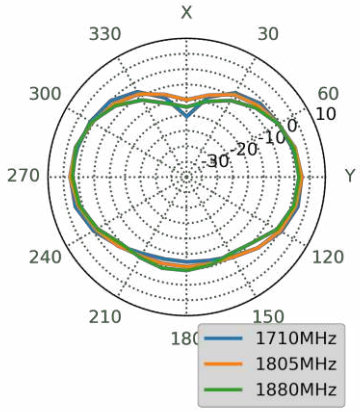

XZ Plane

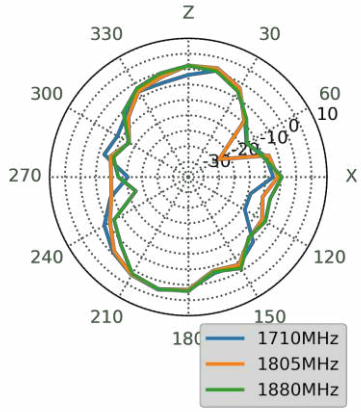

YZ Plane

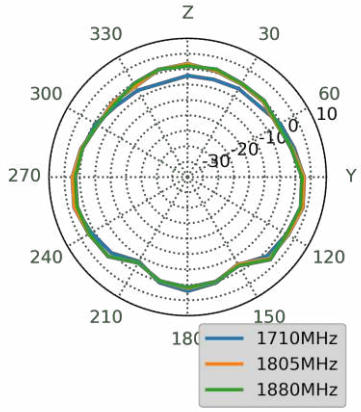

1920MHz

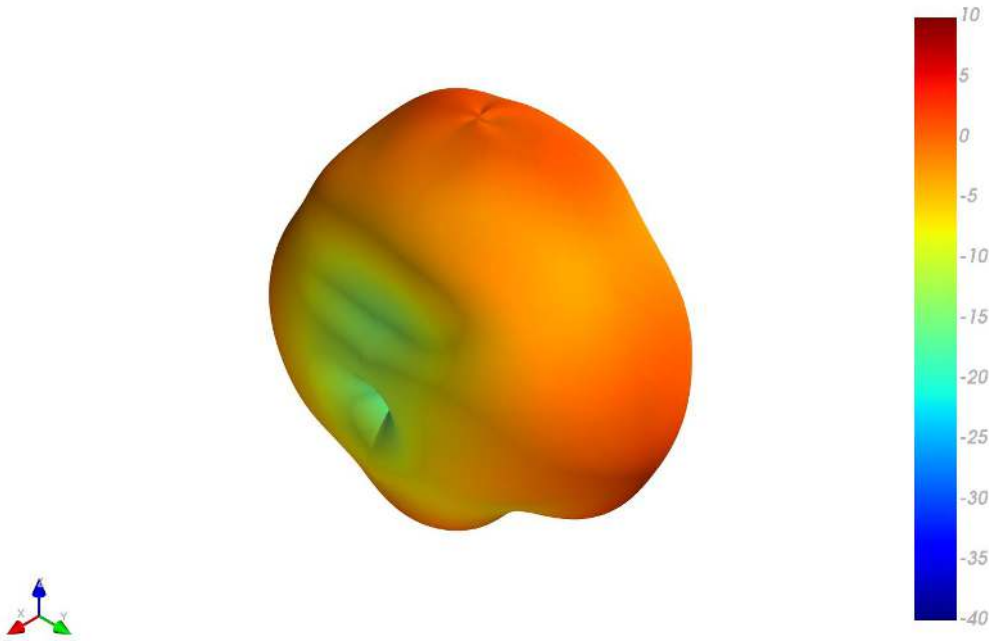

XY Plane

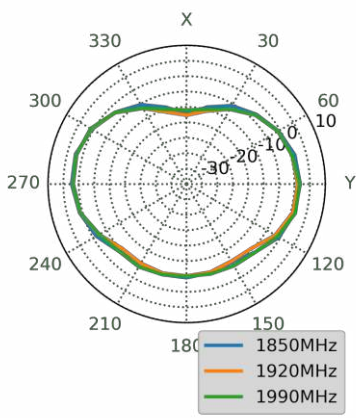

XZ Plane

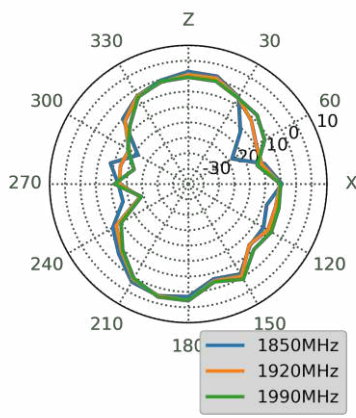

YZ Plane

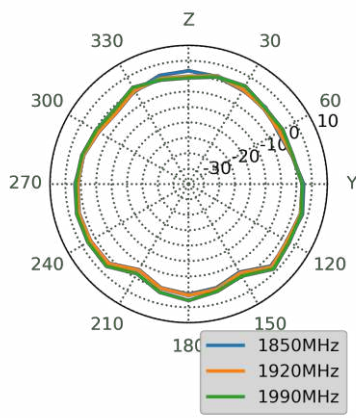

1990MHz

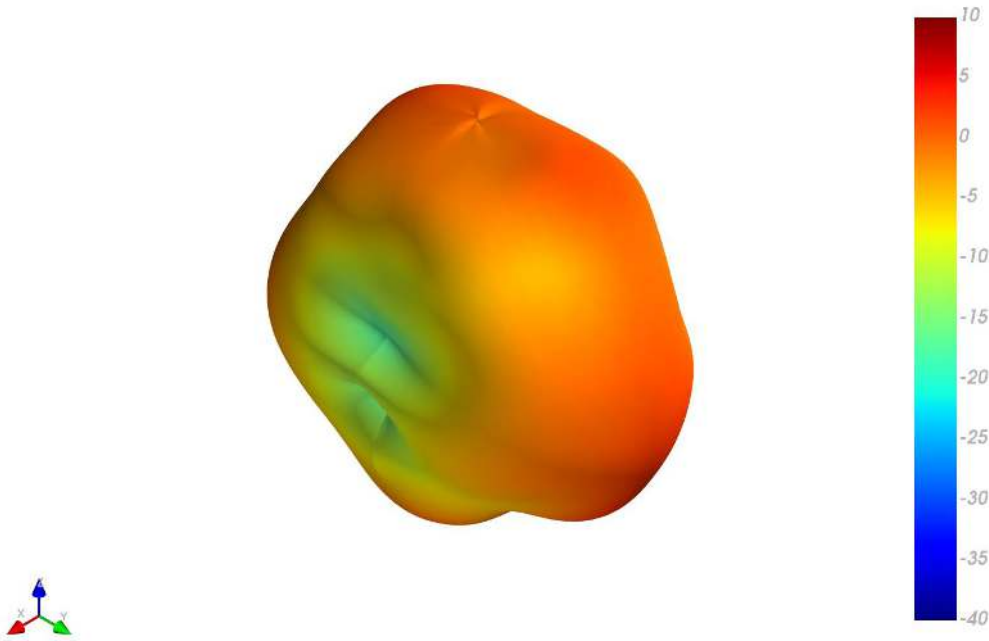

XY Plane

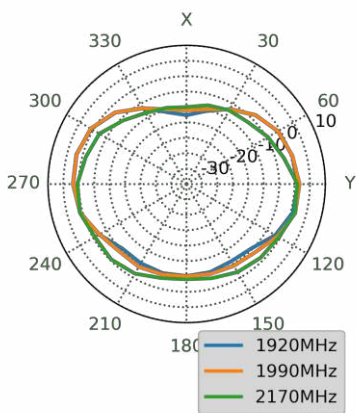

XZ Plane

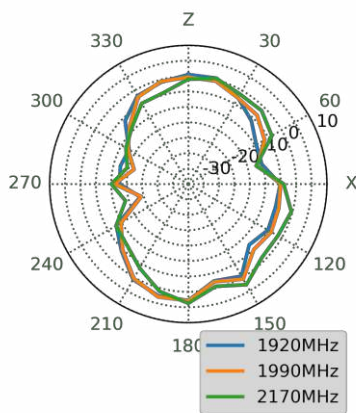

YZ Plane

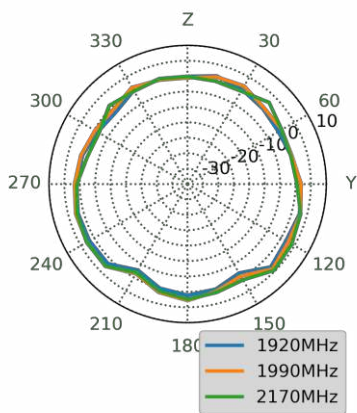

2595MHz

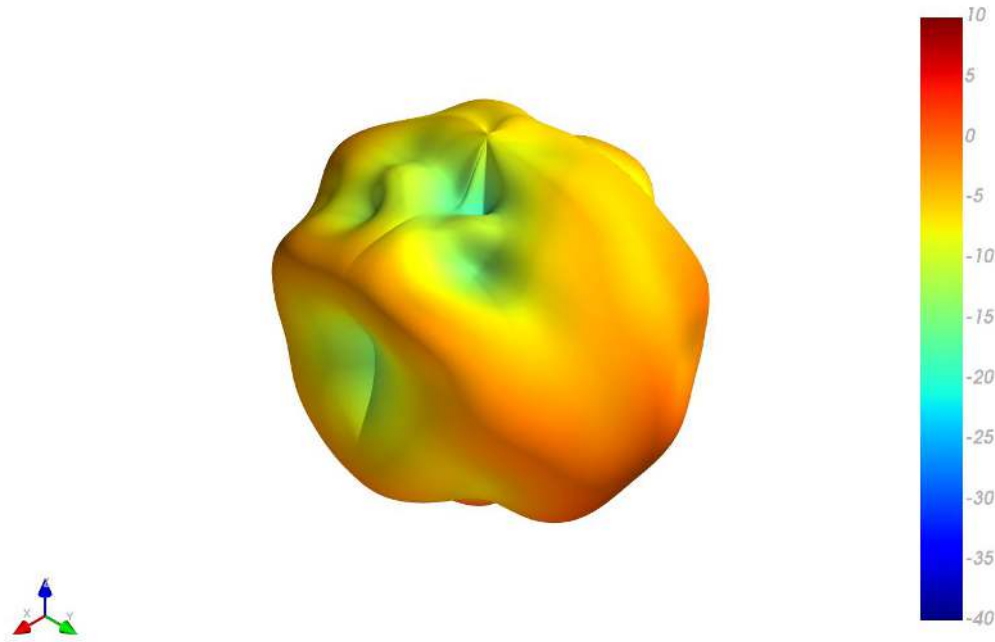

XY Plane

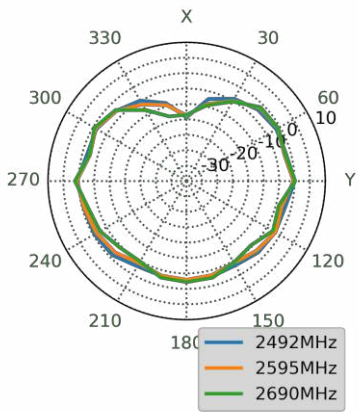

XZ Plane

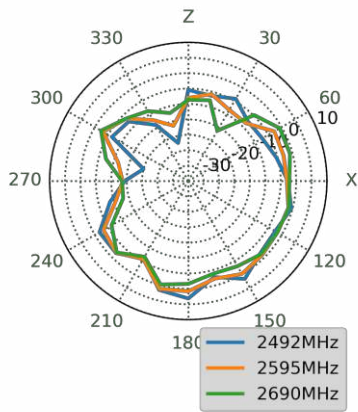

YZ Plane

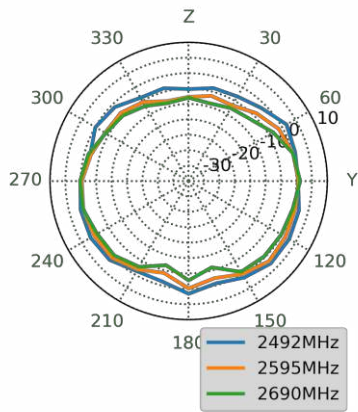

3550MHz

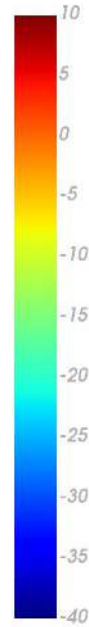
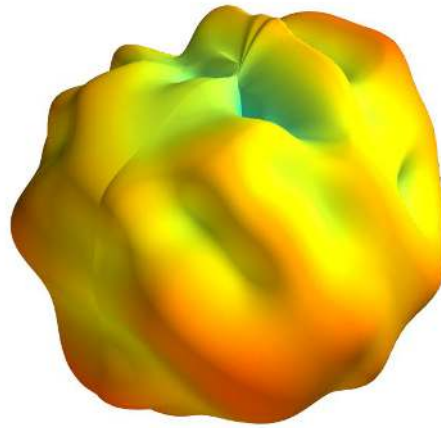

XY Plane

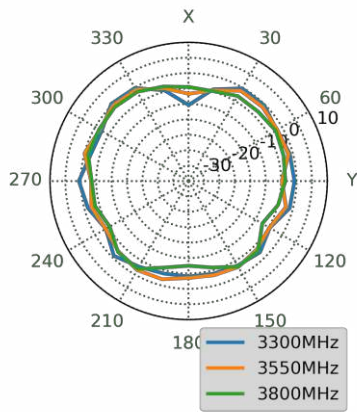

XZ Plane

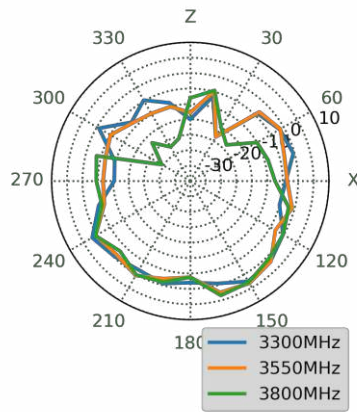

YZ Plane

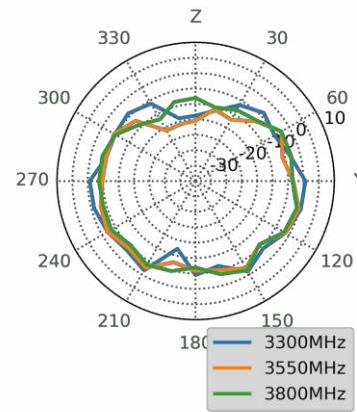

5530MHz

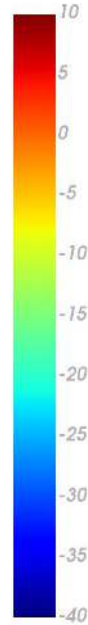
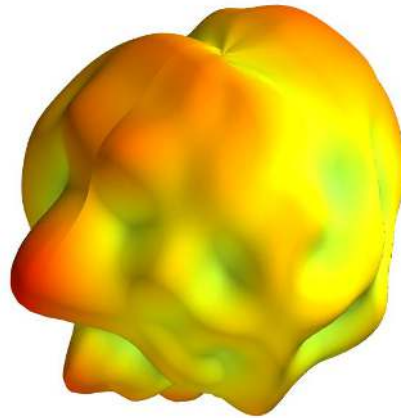

XY Plane

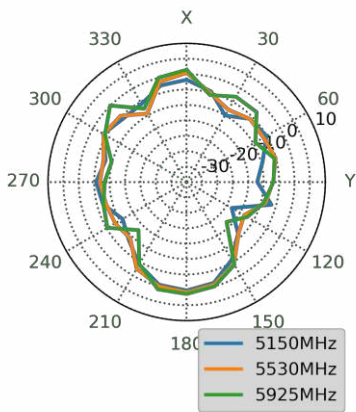

XZ Plane

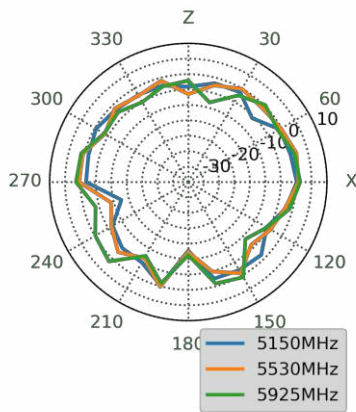

YZ Plane

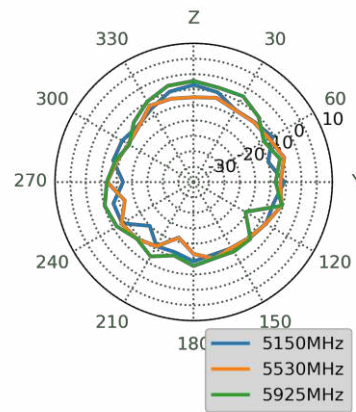

4.3 MIMO 2, 3D and 2D Radiation Patterns

652MHz

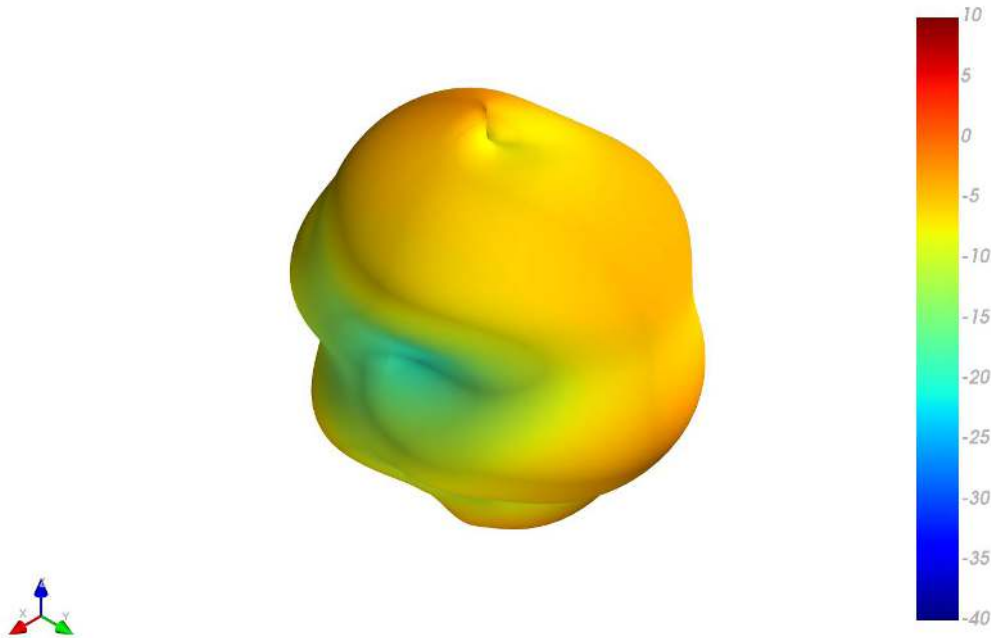

XY Plane

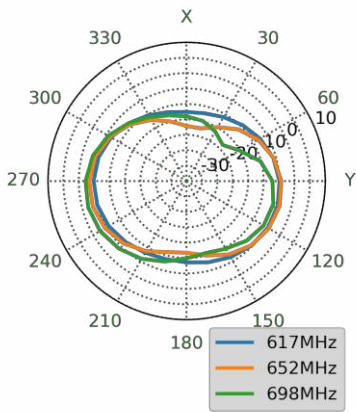

XZ Plane

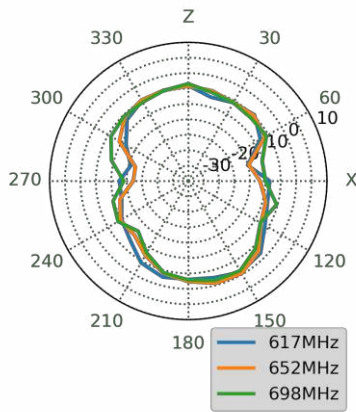

YZ Plane

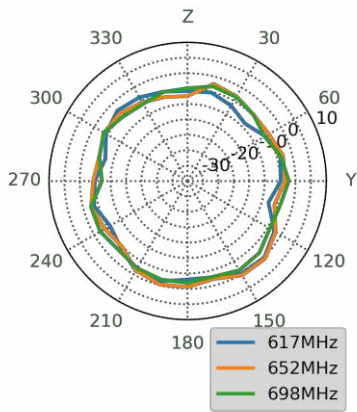

751MHz

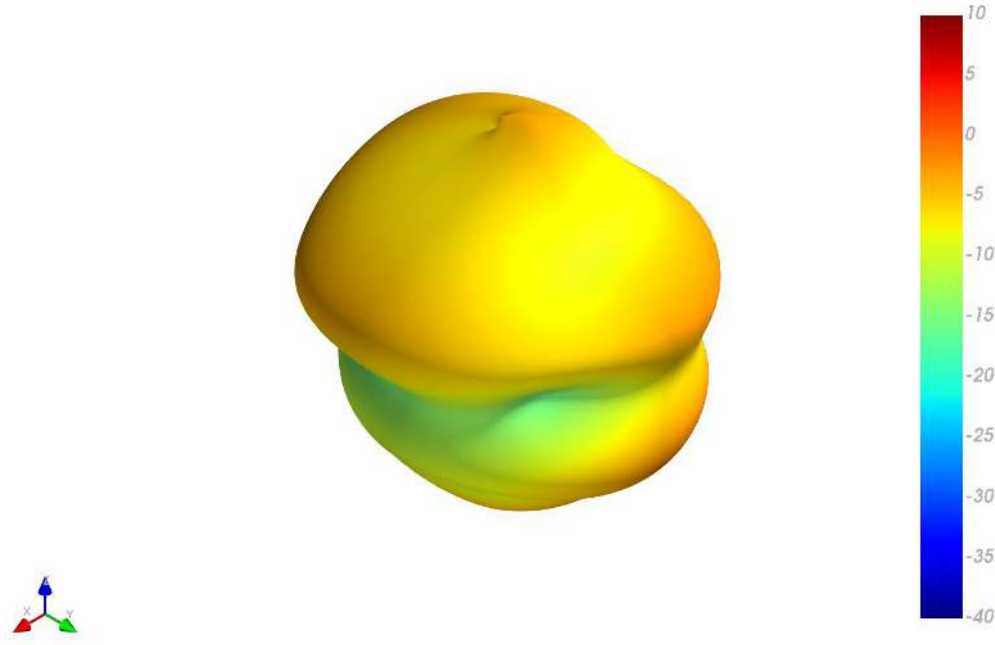

XY Plane

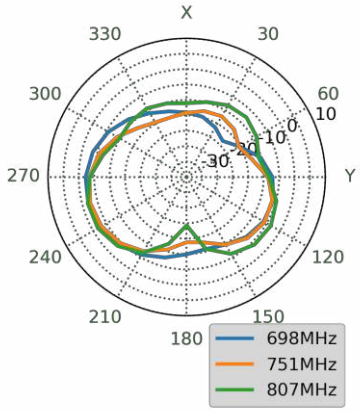

XZ Plane

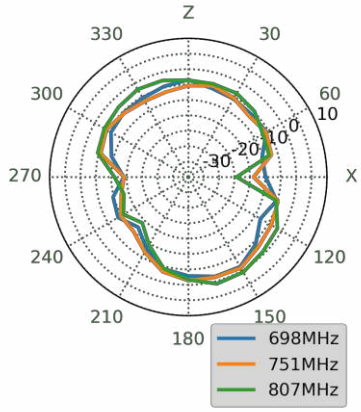

YZ Plane

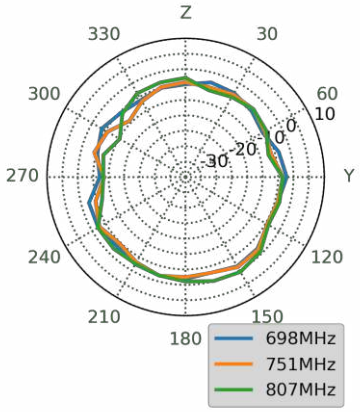

890MHz

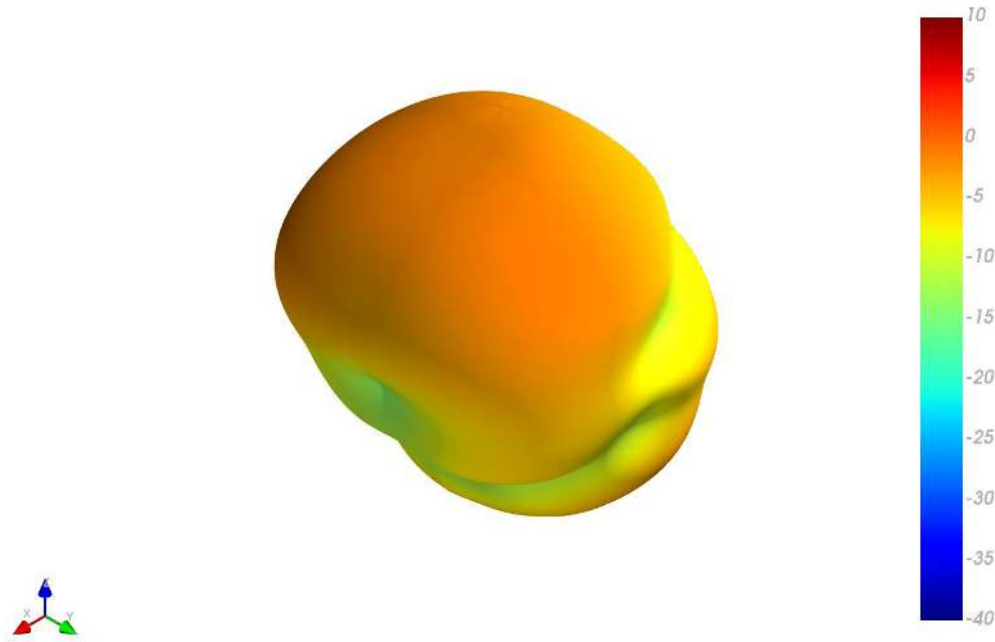

XY Plane

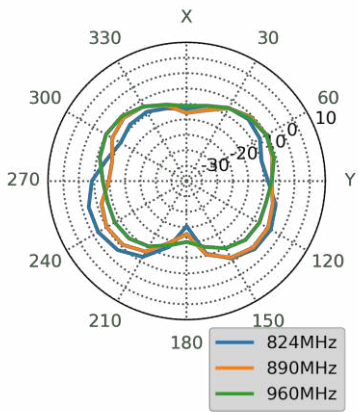

XZ Plane

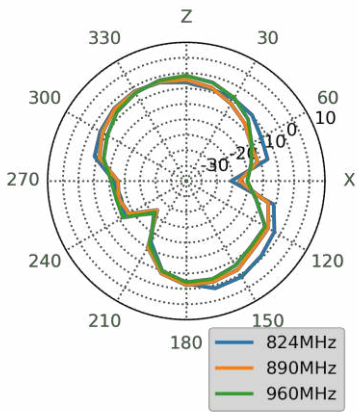

YZ Plane

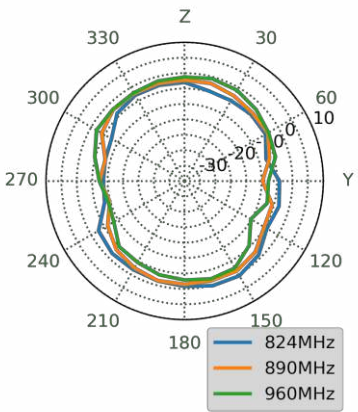

1470MHz

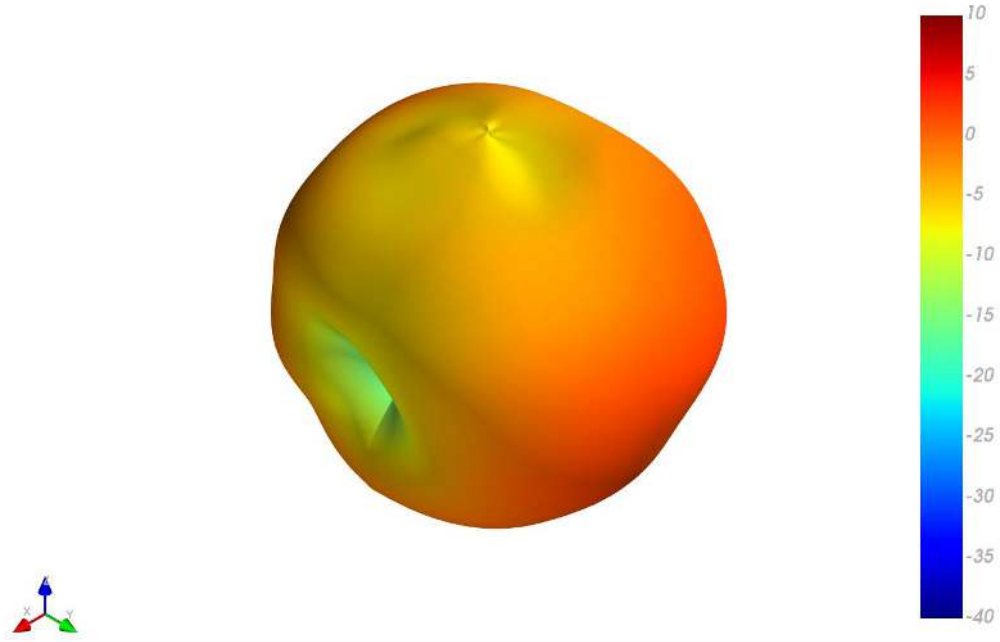

XY Plane

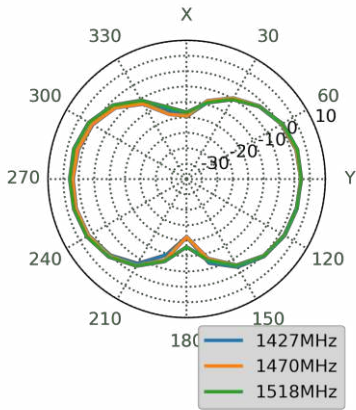

XZ Plane

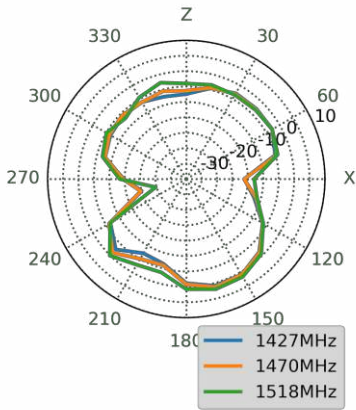

YZ Plane

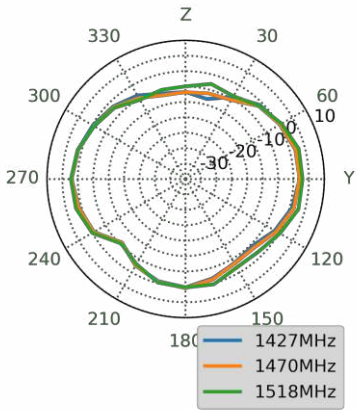

1805MHz

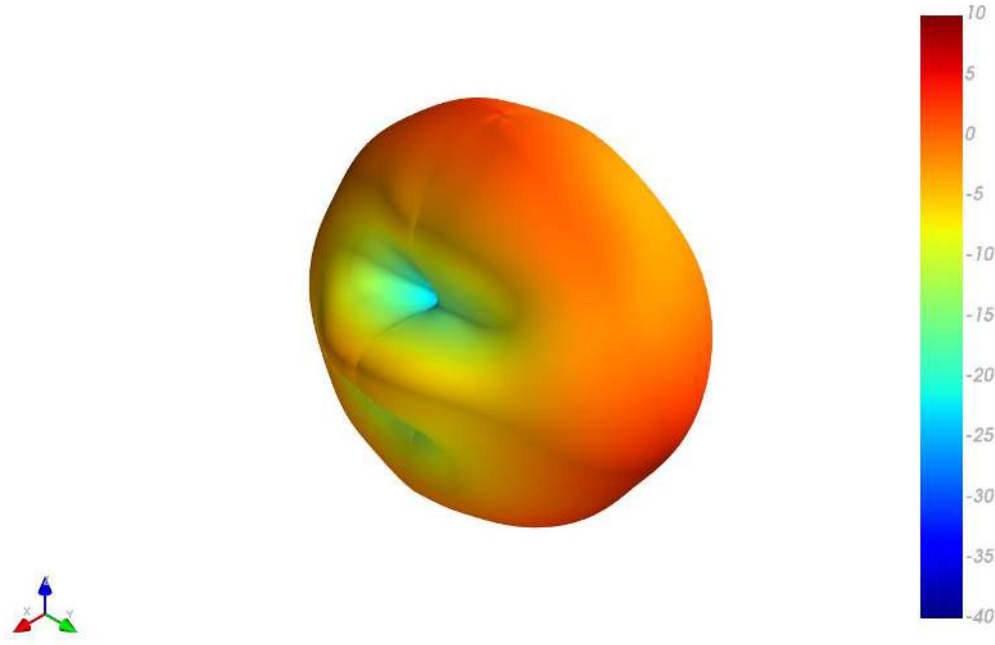

XY Plane

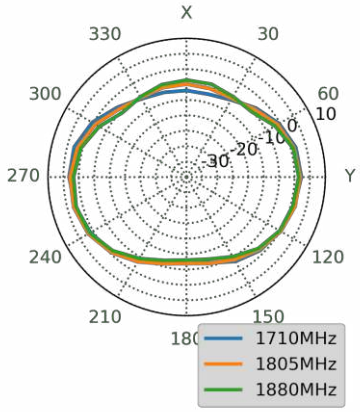

XZ Plane

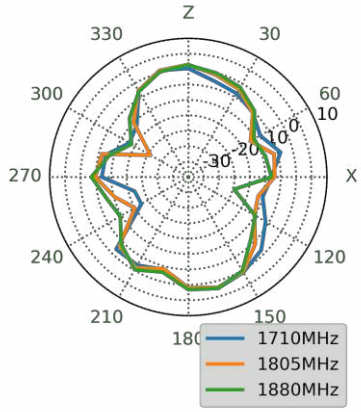

YZ Plane

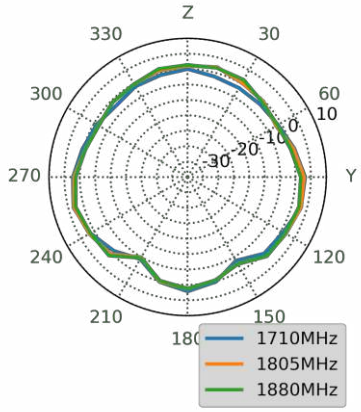

1920MHz

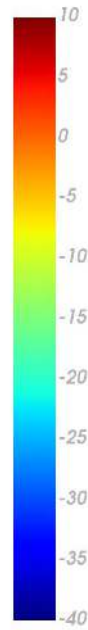
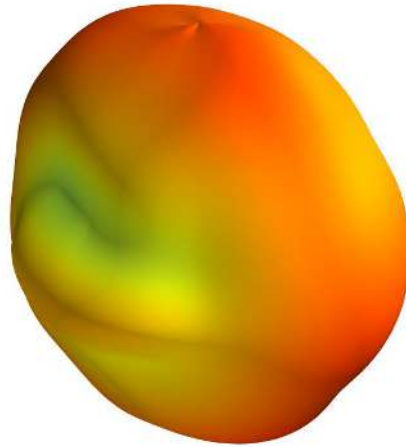

XY Plane

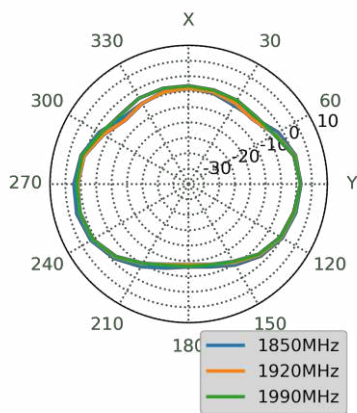

XZ Plane

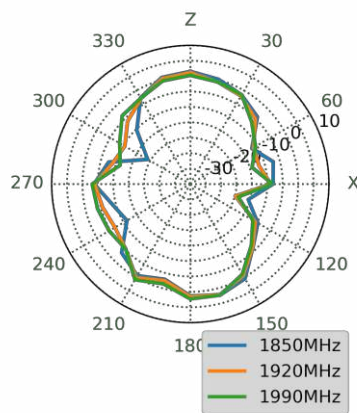

YZ Plane

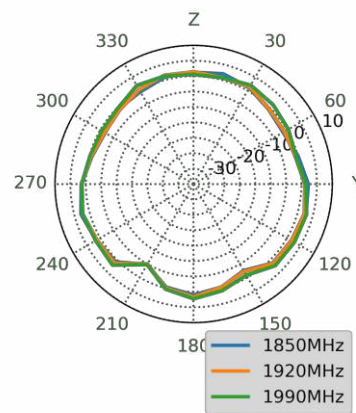

1990MHz

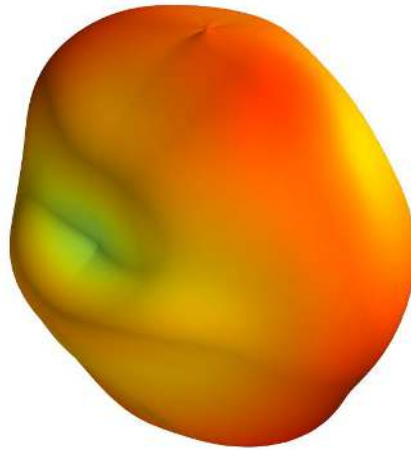

XY Plane

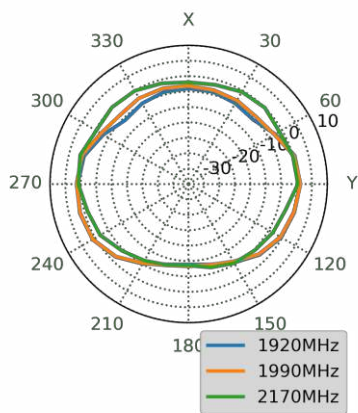

XZ Plane

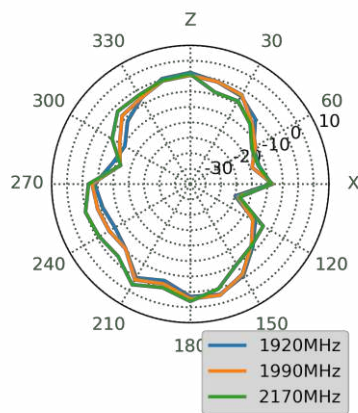

YZ Plane

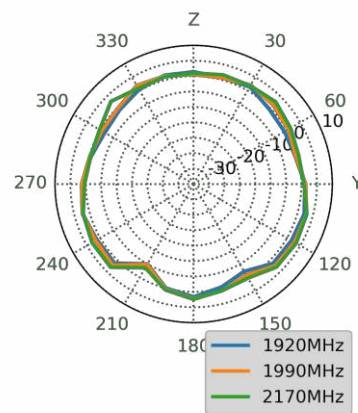

2595MHz

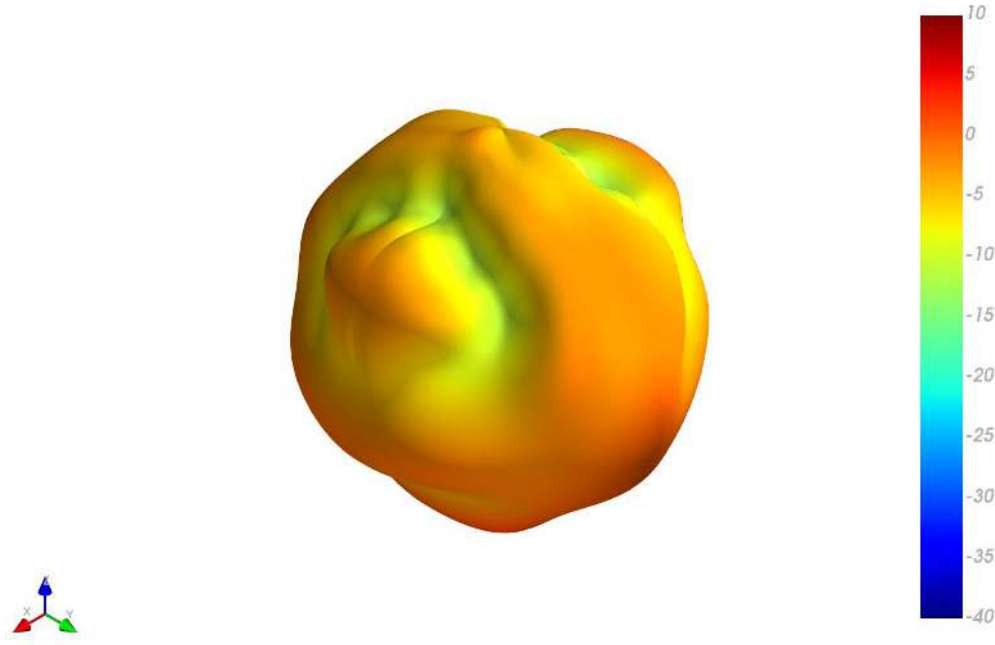

XY Plane

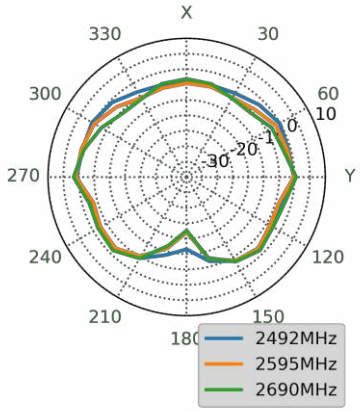

XZ Plane

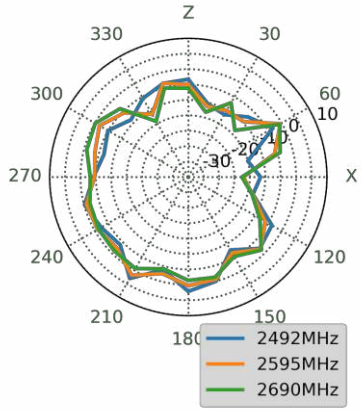

YZ Plane

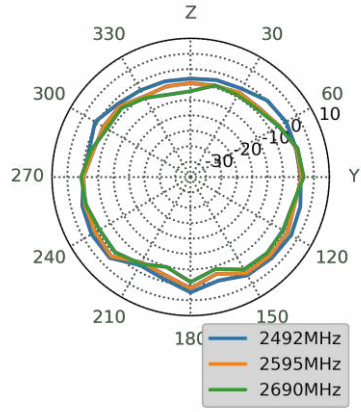

3550MHz

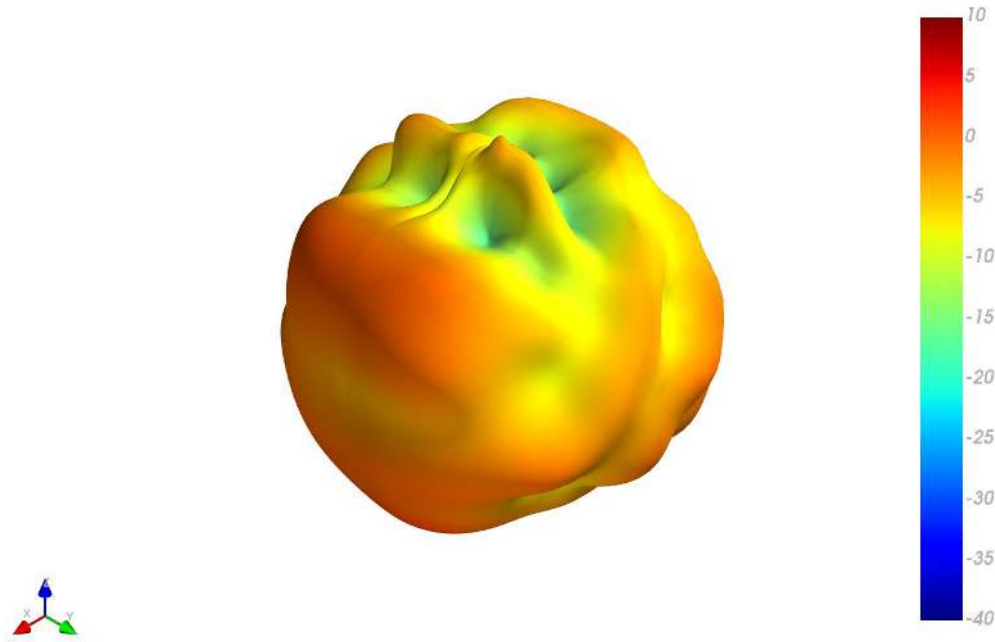

XY Plane

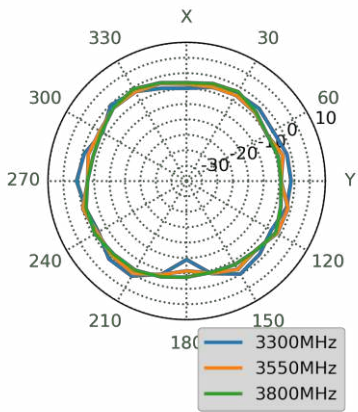

XZ Plane

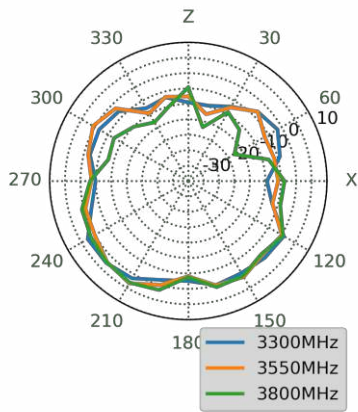

YZ Plane

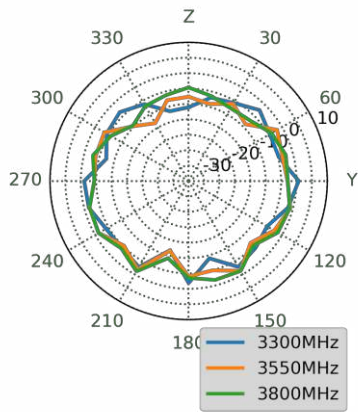

5530MHz

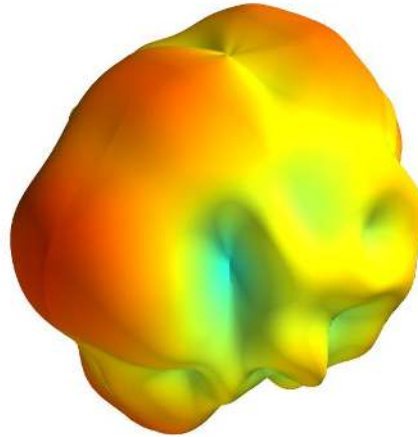

XY Plane

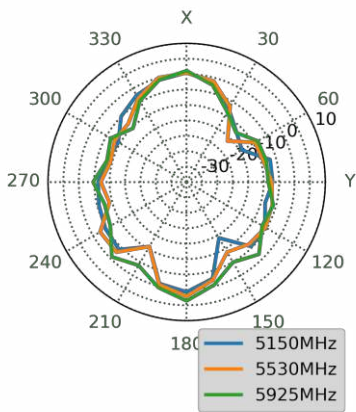

XZ Plane

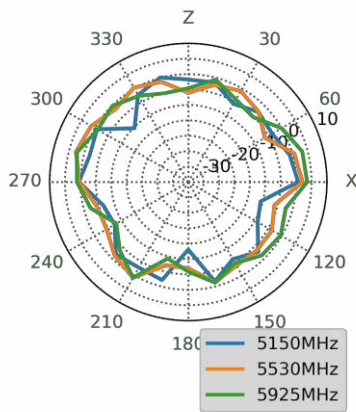

YZ Plane

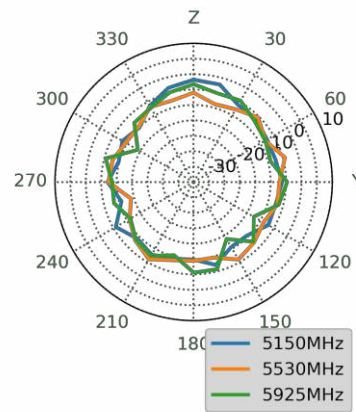

5. Mechanical Drawing (Units: mm)

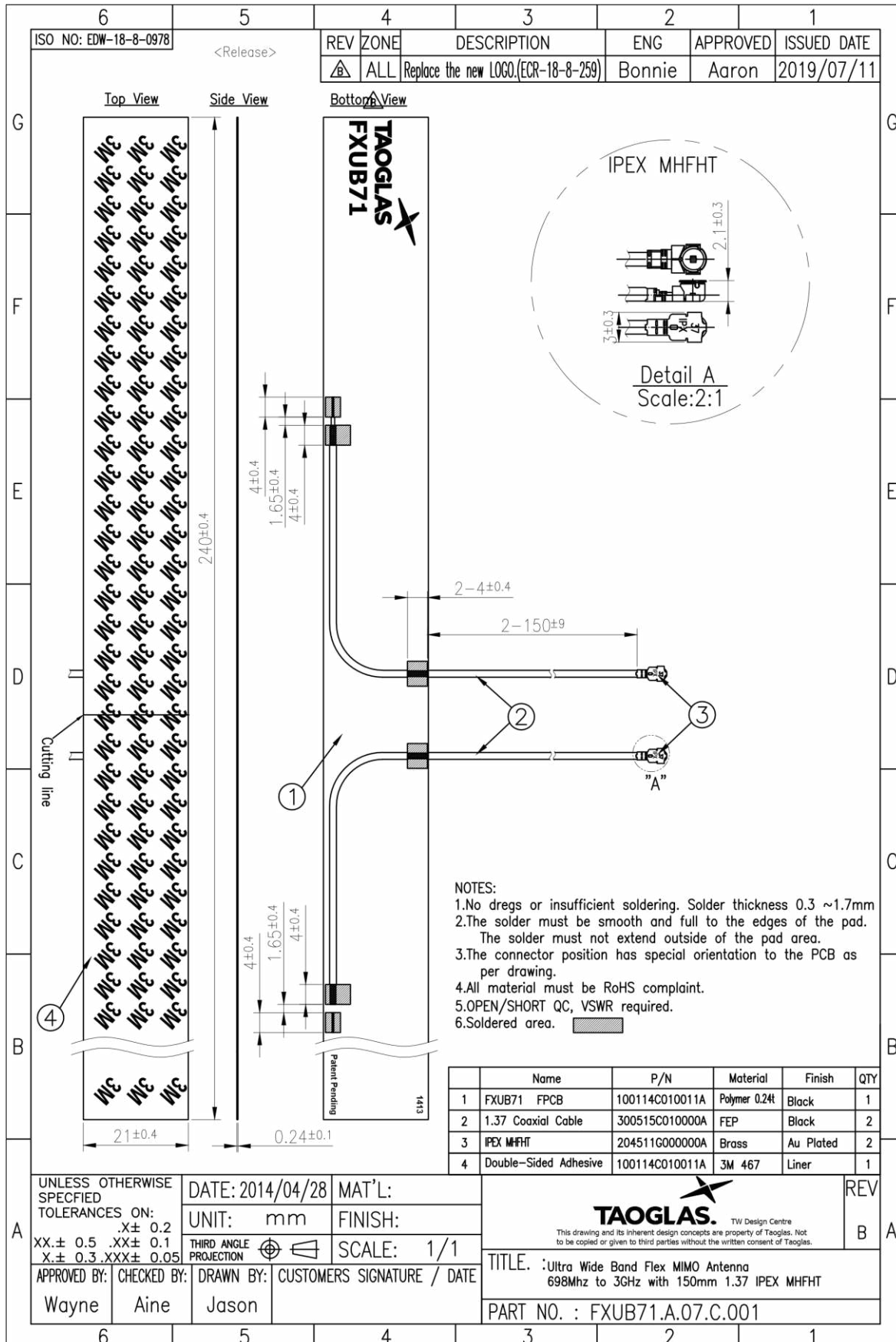

6. Packaging

FXUB71.A.07.C.001

Packaging Specifications

50 pcs FXUB71.A.07.C.001 per PE bag
 PE Bag Dimensions - 430 x 280mm
 Weight - 235.5g

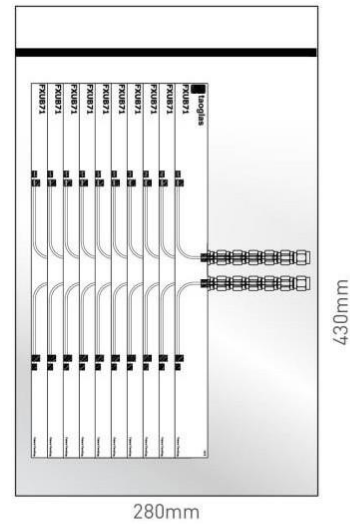

20 PE bags per carton
 1000 pcs FXUB71.A.07.C.001 per carton
 Carton Dimensions - 390*270*350 mm
 Weight - 5.4kg

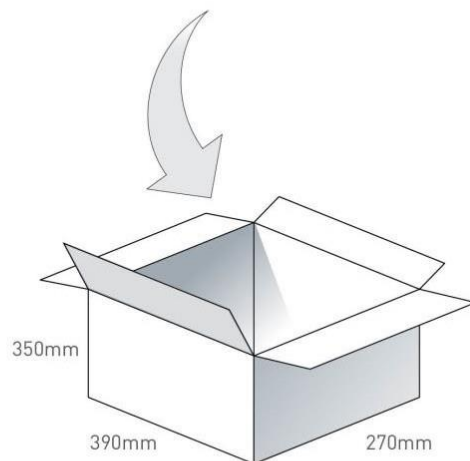

Pallet Dimensions 1200*1200*1000mm
 30 Cartons per Pallet
 10 Cartons per layer
 3 Layers

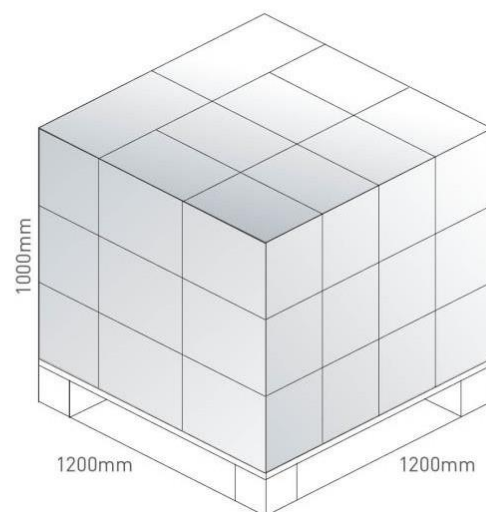

Changelog for the datasheet

SPE-14-8-068 – FXUB71.A.07.C.001

Revision: E (Current Version)

Date:	2020-10-30
Changes:	Updated to Include 5G
Changes Made by:	Jack Conroy

Previous Revisions

Revision: D

Date:	2017-04-04
Changes:	Updated Bands Table
Changes Made by:	Jack Conroy

Revision: C

Date:	2015-06-10
Changes:	Packaging Details Updated
Changes Made by:	Aine Doyle

Revision: B

Date:	2015-06-26
Changes:	Updated Data
Changes Made by:	Aine Doyle

Revision: A (Original First Release)

Date:	2017-08-10
Notes:	
Author:	Your Name Here



TAOGLAS®

www.taoglas.com

