

HP Series



UL Recognized
 ENEC Approved
 ROHS Compliant



The HP series is the new power entry module developed for medical as well as general purpose applications with EMI suppression up to 12 A. Three options are available within this series: General Purpose, HG option with 1 MOOP (Means of Patient Protection) and NG option with 2 MOOP (Means of Operator Protection) compliance with UL60601. A total of 96 variants are offered for a wide range of different applications, with versatile features, and protection for medical patients & operators. The HP series is suitable for use in Class I or Class II medical equipment (UL60601), such as Dental Lighting, Medical Imaging Equipment, Therapeutic Equipment, Medical X-Ray Equipment, Medical Imaging Systems, Ultrasound Equipment etc. Corcom HP PEM is designed using Eco-design principles, and its housing is made of post-consumer recycled material.

Features

- High Protection Power Entry Module
- Compatible with V-Lock plug
- Compact / Light Weight
- 2 MOOP (double insulated, 3 kV) UL60601 -NG
- 1 MOOP (grounded, 5 μ A leakage) UL60601 -HG
- DPST Switch with rocker-guard option
- Compact, flanged or Snap-In
- Single- or Dual-Fusing
- Shrouded FASTONs (for Class II protection)

Applications

- General purpose
- Medical devices
- Instruments
- Portable electrical/electronic devices
- Laboratory equipment
- Home appliances
- Office equipment
- Telecom devices

Electrical Schematics

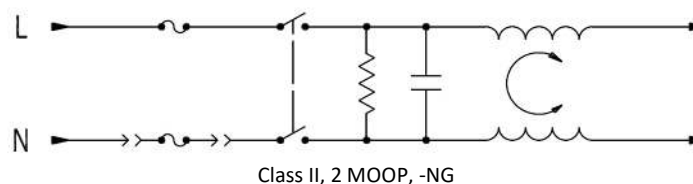
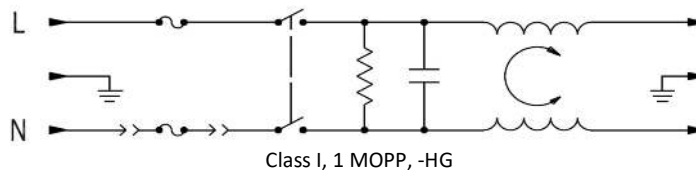
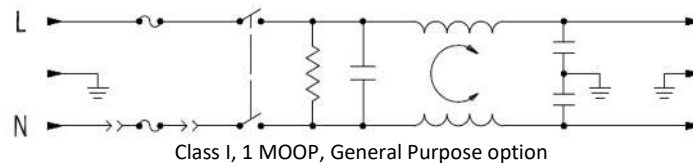

Electrical Specifications

Maximum leakage current per Line to Ground	General Purpose	-HG, -NG
@120V, 60Hz	70 μ A	2 μ A
@250V, 50 Hz	140 μ A	5 μ A
HIPOT rating (2 s)		
L-G Class I	2250 VAC	
L-G Class II, (-NG)	3000 VAC	
Line to Line	1500 VDC	
Rated Voltage	120/250 VAC	
Operating Frequency	50/60 Hz	
Switch	DPST, 10,000 operations at 51 A max. Inrush	
Current Overload	2 X Rated for 8 second †	
Humidity	21 days, 40C @95% RH	
Operating Ambient Temperature	-40C to 40C†	
Storage Temperature	-40C to 85C	
Compatible with V-lock Plug	With IEC 60320 C14 or C18 socket	
† Use 14 AWG power cord for current over 6 A. Limit fault current to 12 A at 40C.		

Case Styles

HPE – Flange type

HPS – Snap-In type

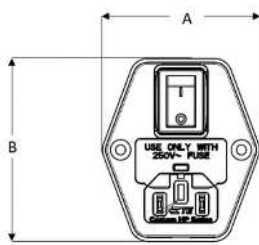

Class II, IEC 60320 C18

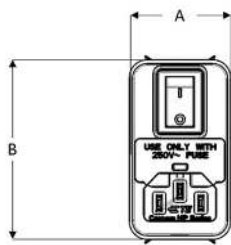

Class I, IEC 60320 C14

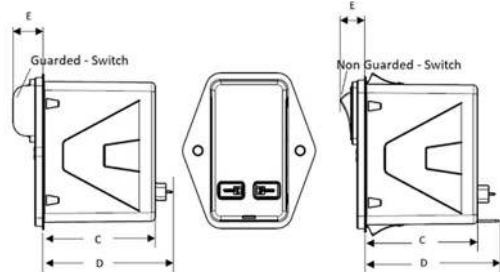

6.3 x 0.8 mm output terminals comply with IEC61210.

Case Dimensions

Part #	A	B	C	D	E
HPE	52	60.5	43.6	50.7	11.9
HPS	34	60.5	43.6	52.2	10.0

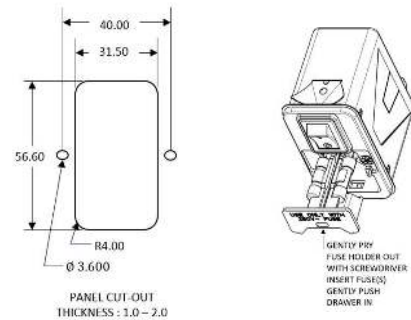

Typical Insertion Loss

General purpose versions

Measured in closed 50-ohm system

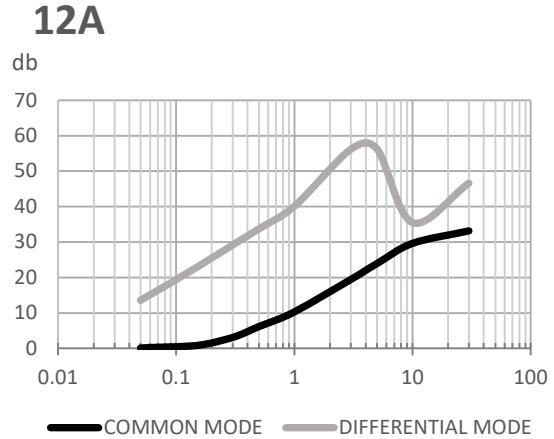
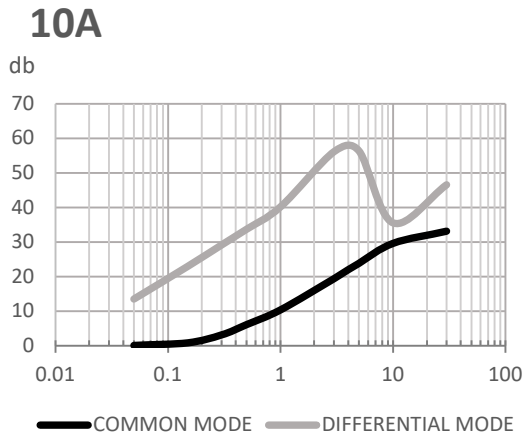
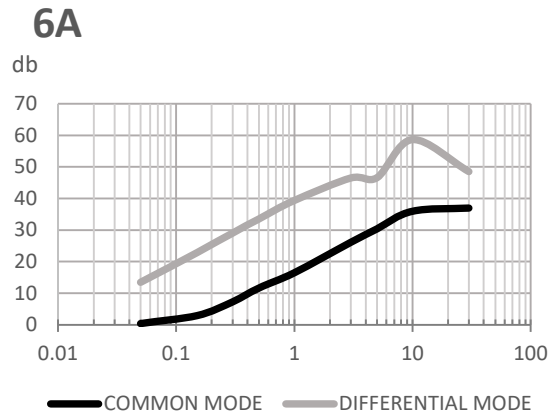
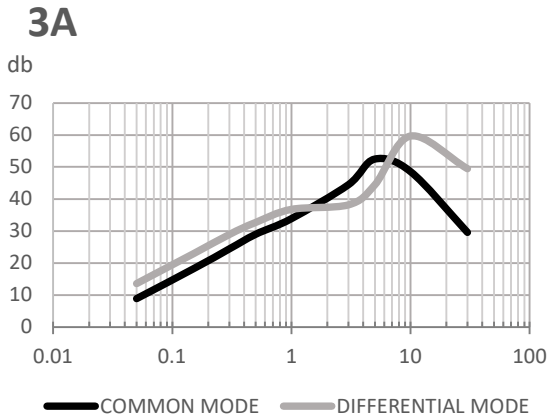

Typical Insertion Loss

-NG and -HG versions

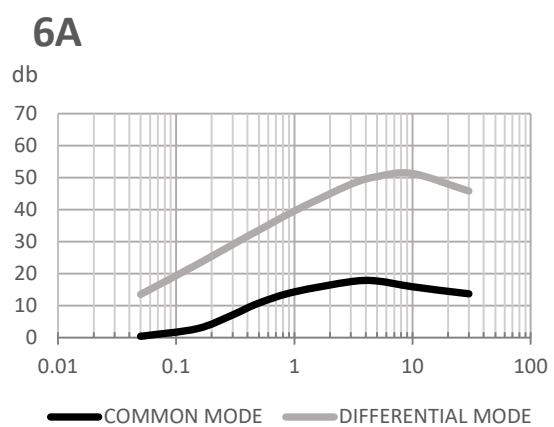
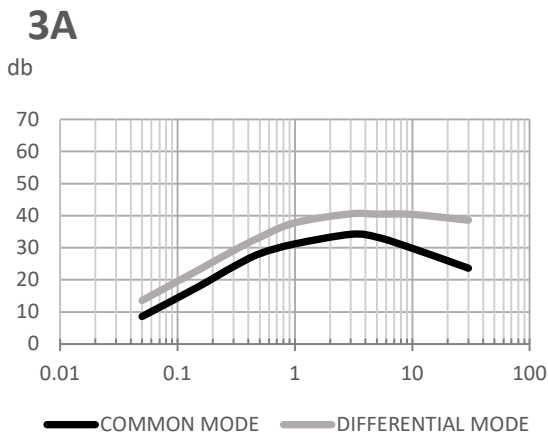

10A

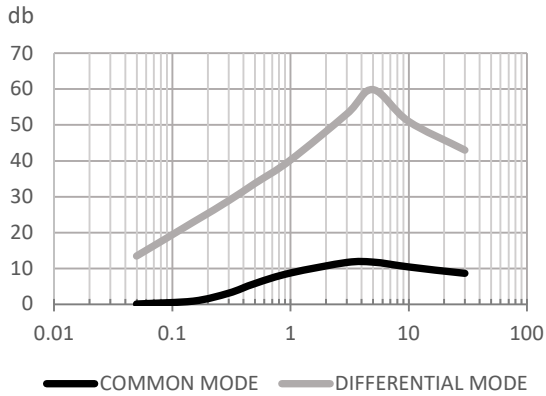

12A

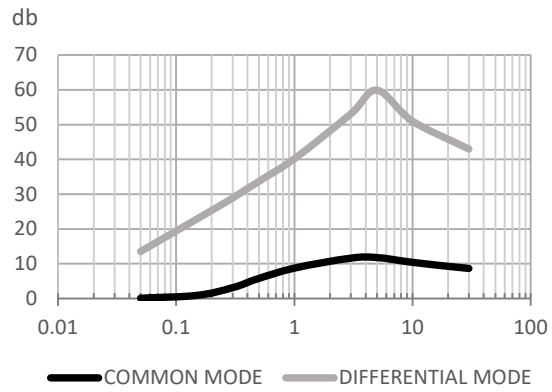

Minimum Insertion Loss General purpose versions

INSERTION LOSS [dB]																
-	COMMON MODE/ Asymmetrical (Line to Ground)								DIFFERENTIAL MODE / Symmetrical (Line to Line)							
	3		6		10		12		3		6		10		12	
MHz	TYP	MIN	TYP	MIN	TYP	MIN	TYP	MIN	TYP	MIN	TYP	MIN	TYP	MIN	TYP	MIN
0.05	9	3	0	0	0	0	0	0	14	8	13	7	14	8	14	8
0.15	18	12	3	0	1	0	1	0	23	17	23	17	23	17	23	17
0.3	24	18	7	1	3	0	3	0	29	23	29	23	29	23	29	23
0.5	29	23	12	6	6	0	6	0	33	27	34	28	34	28	34	28
1	34	24	17	7	10	0	10	0	37	27	39	29	40	30	40	30
3	45	35	26	16	19	9	19	9	38	28	47	37	56	46	56	46
5	53	43	30	20	24	14	24	14	44	34	47	37	56	46	56	46
10	49	34	36	21	30	15	30	15	60	45	59	44	35	20	35	20
30	30	15	37	22	33	18	33	18	50	35	49	34	47	32	47	32

Minimum Insertion Loss -NG, -HG versions

INSERTION LOSS [dB]																
-NG and -HG	COMMON MODE/ Asymmetrical (Line to Ground)								DIFFERENTIAL MODE / Symmetrical (Line to Line)							
	3A		6A		10A		12A		3A		6A		10A		12A	
MHz	TYP	MIN	TYP	MIN	TYP	MIN	TYP	MIN	TYP	MIN	TYP	MIN	TYP	MIN	TYP	MIN
0.05	9	3	0	0	0	0	0	0	14	8	14	8	14	8	14	8
0.15	18	12	3	0	1	0	1	0	23	17	23	17	23	17	23	17
0.3	24	18	7	1	3	0	3	0	29	23	29	23	29	23	29	23
0.5	28	22	11	5	6	0	6	0	33	27	34	28	34	28	34	28
1	31	21	14	4	9	0	9	0	38	28	40	30	40	30	40	30
3	34	24	18	8	12	2	12	2	41	31	48	38	53	43	53	43
5	33	23	18	8	12	2	12	2	41	31	50	40	60	50	60	50
10	30	15	16	1	10	0	10	0	40	25	51	36	51	36	51	36
30	24	9	14	0	9	0	9	0	39	24	46	31	43	28	43	28

Ordering Information (Part Description)

EXAMPLE: 12HPENS1
 12 A **
 FLANGED
 NO SWITCH GUARD
 SINGLE-FUSE
 GENERAL PURPOSE

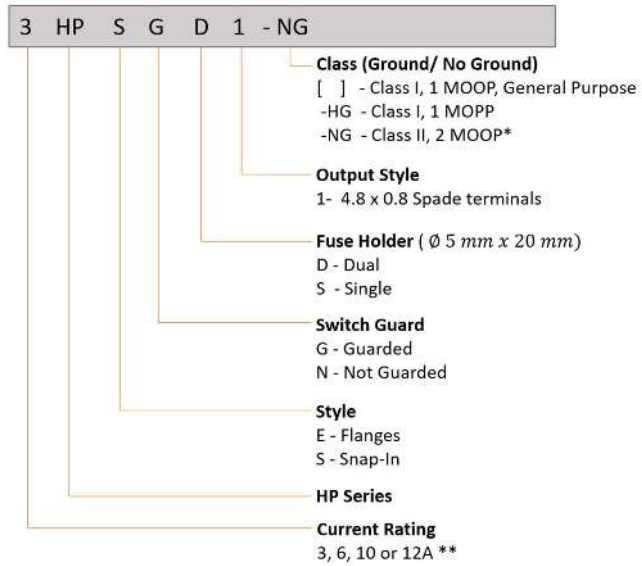

*Class II with insulated FASTONS.
 ** RATED 12 A UL/CSA, 10 A ENEC.

Available Part Numbers Class I, 1 MOOP, General purpose

Part Description	Part Number	Weight, g	Part Description	Part Number	Weight, g
Snap-In, Guarded, Single Fuse			Snap-In, Guarded, Double Fuse		
3HPSGS1	1-1609158-4	68	3HPSGD1	1-1609158-0	68
6HPSGS1	1-1609158-5	68	6HPSGD1	1-1609158-1	68
10HPSGS1	1-1609158-6	68	10HPSGD1	1-1609158-2	68
12HPSGS1	1-1609158-7	68	12HPSGD1	1-1609158-3	68
Flanges, Guarded, Single Fuse			Flanges, Guarded, Double Fuse		
3HPEGS1	2-1609158-2	80	3HPEGD1	1-1609158-8	80
6HPEGS1	2-1609158-3	80	6HPEGD1	1-1609158-9	80
10HPEGS1	2-1609158-4	80	10HPEGD1	2-1609158-0	80
12HPEGS1	2-1609158-5	80	12HPEGD1	2-1609158-1	80
Snap-In, Non-Guarded, Single Fuse			Snap-In, Non-Guarded, Double Fuse		
3HPSNS1	3-1609158-0	68	3HPSND1	2-1609158-6	68
6HPSNS1	3-1609158-1	68	6HPSND1	2-1609158-7	68
10HPSNS1	3-1609158-2	68	10HPSND1	2-1609158-8	68
12HPSNS1	3-1609158-3	68	12HPSND1	2-1609158-9	68
Flanges, Non-Guarded, Single Fuse			Flanges, Non-Guarded, Double Fuse		
3HPENS1	3-1609158-8	80	3HPEND1	3-1609158-4	80
6HPENS1	3-1609158-9	80	6HPEND1	3-1609158-5	80
10HPENS1	4-1609158-0	80	10HPEND1	3-1609158-6	80
12HPENS1	4-1609158-1	80	12HPEND1	3-1609158-7	80

Continued ...

HG, Class I, 1 MOPP

Part Description	Part Number	Weight, g	Part Description	Part Number	Weight, g
Snap-In, Guarded, Single Fuse			Snap-In, Guarded, Double Fuse		
3HPSGS1-HG	7-1609158-8	68	3HPSGD1-HG	7-1609158-4	68
6HPSGS1-HG	7-1609158-9	68	6HPSGD1-HG	7-1609158-5	68
10HPSGS1-HG	8-1609158-0	68	10HPSGD1-HG	7-1609158-6	68
12HPSGS1-HG	8-1609158-1	68	12HPSGD1-HG	7-1609158-7	68
Flanges, Guarded, Single Fuse			Flanges, Guarded, Double Fuse		
3HPEGS1-HG	8-1609158-6	80	3HPEGD1-HG	8-1609158-2	80
6HPEGS1-HG	8-1609158-7	80	6HPEGD1-HG	8-1609158-3	80
10HPEGS1-HG	8-1609158-8	80	10HPEGD1-HG	8-1609158-4	80
12HPEGS1-HG	8-1609158-9	80	12HPEGD1-HG	8-1609158-5	80
Snap-In, Non-Guarded, Single Fuse			Snap-In, Non-Guarded, Double Fuse		
3HPSNS1-HG	9-1609158-4	68	3HPSND1-HG	9-1609158-0	68
6HPSNS1-HG	9-1609158-5	68	6HPSND1-HG	9-1609158-1	68
10HPSNS1-HG	9-1609158-6	68	10HPSND1-HG	9-1609158-2	68
12HPSNS1-HG	9-1609158-7	68	12HPSND1-HG	9-1609158-3	68
Flanges, Non-Guarded, Single Fuse			Flanges, Non-Guarded, Double Fuse		
3HPENS1-HG	1-1609157-2	80	3HPEND1-HG	9-1609158-8	80
6HPENS1-HG	1-1609157-3	80	6HPEND1-HG	9-1609158-9	80
10HPENS1-HG	1-1609157-4	80	10HPEND1-HG	1-1609157-0	80
12HPENS1-HG	1-1609157-5	80	12HPEND1-HG	1-1609157-1	80

NG, Class II, 2 MOOP (Insulated FASTON)

Part Description	Part Number	Weight, g	Part Description	Part Number	Weight, g
Snap-In, Guarded, Single Fuse			Snap-In, Guarded, Double Fuse		
3HPSGS1-NG	4-1609158-6	68	3HPSGD1-NG	4-1609158-2	68
6HPSGS1-NG	4-1609158-7	68	6HPSGD1-NG	4-1609158-3	68
10HPSGS1-NG	4-1609158-8	68	10HPSGD1-NG	4-1609158-4	68
12HPSGS1-NG	4-1609158-9	68	12HPSGD1-NG	4-1609158-5	68
Flanges, Guarded, Single Fuse			Flanges, Guarded, Double Fuse		
3HPEGS1-NG	5-1609158-4	80	3HPEGD1-NG	5-1609158-0	80
6HPEGS1-NG	5-1609158-5	80	6HPEGD1-NG	5-1609158-1	80
10HPEGS1-NG	5-1609158-6	80	10HPEGD1-NG	5-1609158-2	80
12HPEGS1-NG	5-1609158-7	80	12HPEGD1-NG	5-1609158-3	80
Snap-In, Non-Guarded, Single Fuse			Snap-In, Non-Guarded, Double Fuse		
3HPSNS1-NG	6-1609158-2	68	3HPSND1-NG	5-1609158-8	68
6HPSNS1-NG	6-1609158-3	68	6HPSND1-NG	5-1609158-9	68
10HPSNS1-NG	6-1609158-4	68	10HPSND1-NG	6-1609158-0	68
12HPSNS1-NG	6-1609158-5	68	12HPSND1-NG	6-1609158-1	68
Flanges, Non-Guarded, Single Fuse			Flanges, Non-Guarded, Double Fuse		
3HPENS1-NG	7-1609158-0	80	3HPEND1-NG	6-1609158-6	80
6HPENS1-NG	7-1609158-1	80	6HPEND1-NG	6-1609158-7	80
10HPENS1-NG	7-1609158-2	80	10HPEND1-NG	6-1609158-8	80
12HPENS1-NG	7-1609158-3	80	12HPEND1-NG	6-1609158-9	80

te.com

Corcom, TE Connectivity, TE, TE Connectivity (logo) and Every Connection Counts are trademarks. All other logos, products and/or company names referred to herein might be trademarks of their respective owners

The information given herein, including drawings, illustrations and schematics which are intended for illustration purposes only, is believed to be reliable. However, TE Connectivity makes no warranties as to its accuracy or completeness and disclaims any liability in connection with its use. TE Connectivity's obligations shall only be as set forth in TE Connectivity's Standard Terms and Conditions of Sale for this product and in no case will TE Connectivity be liable for any incidental, indirect or consequential damages arising out of the sale, resale, use or misuse of the product. Users of TE Connectivity products should make their own evaluation to determine the suitability of each such product for the specific application.

© 2022 TE Connectivity. All Rights Reserved.

Version 11/2022